



*More Than Gifts*

New  
GIFT  
CATALOGUE

2023  
CREATING  
INNOVATION

# OUR IMPACT APRIL 2021 - MARCH 2022



**Total Savings**

  
**63,311,594**  
 LITRES OF WATER SAVED

  
**251,065**  
 PLASTIC BOTTLES RE-PURPOSED

  
**1,752**  
 PEOPLE PROVIDED WITH LASTING SAFE WATER OR SANITATION THROUGH WATER.ORG



Die Handschrift der Werbung  
 A Climate-Neutral Pens Factory in Germany



Impact uses Aware™ tracer technology in the recycled fabrics that proves its recycled origins and authenticates the impact generated



- Tacx bio-bottles are 100% recyclable and bio-degradable
- Tacx bottles are Made from bio-sugarcane
- Made in the Netherlands





 **CHANGE IS IN OUR CHOICES** 



# ICONS

## LUXURY



reSound™ material



Bamboo



Eco Friendly



BPA free



Recycled PET



Water proof

## QUALITY



Bluetooth Enabled



Microphone



Audio



Genuine Leather



Wireless Charging



Dishwasher Safe



## CREATIVE



Camera Accessory



Double Wall



Leak-proof



Battery



Touch Screen



App Related



Light Up Logo

## VALUE



Tested for Antibacterial Effectiveness



Tested for Antimicrobial Effectiveness



Wheat Straw



Antimicrobial



Antibacterial



UV-C Sterilization

## HOW TO USE QR CODES ?

Step 1: Go to PLAY STORE (For Android users) & Download the QR code reader app, Apple users can scan the code directly from the camera app.



Step 2: Launch the downloaded QR code reader app & position your mobile device in such a way that the edges of the QR code fits the boundaries indicated on the screen.

Step 3: The code will be scanned by the app & a beep will be heard following which a link open approval will be prompted. Click OK & you will be directed to the webpage whose address is embed in the QR code.

# BRANDS

## AVAILABLE WITH US IN READY STOCK

A great brand inspires confidence and trust in consumers. Also, its a distinct sense of style and sophistication. Thus, brand-name products are an excellent medium for Advertising and Promotion. Through our exclusive brand-partners from around the globe, we bring you an exciting range of high-quality, on-trend Corporate/Business Gifts and Premiums that you can be proud to associate your brand with.

MOLESKINE®

 CROSS

XDDDESIGN®

SANTHOME

Pitchfix®  
com

Hans Larsen™

 c-secure

ocean  
bottle

XDCOLLECTION

 SWISS  
PEAK®

TUMI

Samsnite

XDXCLUSIVE®

 SKROSS®  
ADAPT TO THE WORLD

SANTHOME  
PROTECT

 SANTHOME  
*Golf • Legacy*

Giftology

 otto hutt

tekhнологia  
by @MEMORI

@MEMORI

vivo®

Villeroy & Boch Group

Tacx

BIO BOTTLES MADE IN THE NETHERLANDS

UMA®

PENS FROM GERMANY

GIORDANO

  
Tonino Lamborghini

eco-neutral

Swiss  
Highlander

DRY mcool  
BEST COMFORT

# BRANDING TECHNIQUES

The essence of promotional gifts and business giveaways is to make your mark on customers

A well branded product that carries your unique logo or brand message helps increase brand recognition, increases business value, generates new customers, improves employee pride & satisfaction and finally creates trust in the marketplace.

A great product needs impactful branding. Now convey your message in style !!



LASER ENGRAVING  
(ENG)



UV PRINTING  
(UV)



SILKSCREEN  
PRINTING(SC)



PAD  
PRINTING



EMBOSSING  
DEBOSSING  
(EMB)



FOILING  
(FO)



EMBROIDERY



HEAT TRANSFER  
PRINTING (HT)



DOMING  
EPOXY (DM)

# CONTENTS

## SUSTAINABLE ECO-FRIENDLY COLLECTION

- The IMPACT Collection, The CHANGE- SERIOUSLY SUSTAINABLE Collection
- XDDESIGN Bobby Bags
- OCEAN BOTTLE
- Drinkware as Water Bottles, Mugs, Flasks and such Sets
- Executive Accessories
- Apparel
- Bags from Recycled Cotton, Normal Cotton, Non-woven, Jute, RPET
- Notebooks, Pens, Stationery Articles, Desk tops, Kids Stuff
- Wellness and Fitness
- Tech

07-80

## TECHNOLOGY FRONTIERS

- Executive Accessories
- Desk Tech
- True Wireless Stereo (TWS) Earbuds, Headphones, Fitness Trackers
- Wireless Chargers incl. Multifunctional, Magnetic
- Powerbanks, Speakers, USB Flash Drives, Portfolio Powerbanks, USB Hubs.
- Promotional Audio, Mobile / Tablet / Charging Accessories, Gadgets, VR
- UV-C Sterilization Technology stands & Holders for Tech Gadgets

69-118

## FIGHT-COVID RANGE: WE ARE RESPONSIBLE

- Tech incl UV-C Sterilization Gadgets
- Masks, Mask Accessories, Touchless Keyrings
- Notebooks and Pens
- Apparel incl. Polos, t-shirts and Caps
- Backpacks

113-126

## FITNESS, WELLNESS AND SPORTS

- Workout Accessories, Activity Trackers, Enabling Accessories
- Accessories for Outdoors
- YOGA mats
- Scented Candles
- GOLF Collection & Requisites

127-148

## DRINKWARE AND FOODWARE

- The IMPACT Collection, The CHANGE- SERIOUSLY SUSTAINABLE Collection
- OCEAN BOTTLE - Range
- Water Bottles, Flasks, Mugs, Tumblers, Protein Shakers, Carafe
- Sets with Drinkware, Tea and Coffee Ware
- Lunch Box

149-204

## APPAREL

- Polo Shirts, T-shirts, Dress Shirts
- Hoodies, Sweater, Caps
- Customised Apparel

205-252

## TRAVEL

- Travel Adapters, Luggage Scale, Neck Pillows, Passport / Documents Holder
- Cabin Trolleys, Overnighters, Garment Bags, Wash Bags
- Tech support Accessories for Travel
- Manicure & Grooming Tools
- Travel Prayer Mats

253-264

## BAGS

- Cabin Trolleys, Overnighters, Garment Bags, Wash Bags
- The IMPACT Collection, The CHANGE- SERIOUSLY SUSTAINABLE Collection
- Backpacks incl Samsonite, Cross, XDDESIGN, Santhome, Moleskine
- Messenger Bags and Laptop / Office Bags from Cross, Moleskine, Santhome
- Cooler Bags, Drawstring Bags, Duffel Bags, Shopping Bags
- Customised and Made in GCC Bags

261-316

## WRITING

- Notebooks, Diaries, Sets of Notebooks and Pens
- Tech Portfolios & Smart Writing Set
- Pens
- Portfolios, Organizers, Folders, Diaries

317-370

## PERSONAL ACCESSORIES

- Card Holders
- Gift Sets
- Moleskine, Cross, C-Secure & Pierre Cardin
- Genuine Leather
- Ladies Gifts
- Manicure & Grooming Tools

371-414

## DESK

- Desktops
- Tech and Lifestyle
- Mousepads, Coasters, Prayer Mats

415-430

## Gifts of Faith / Islamic Gifts

430-431

## YOUNG ONES & HAPPINESS

- Kids Stationery, Games
- Happiness Theme Giveaways

432-433

## Automobile Accessories

434-436

- Miscellaneous, Multi Tools, Lanyards, Keyholders & Boxes

436-444

## Compliance Statements

445

# THE END OF GREENWASHING

Greenwashing refers to false sustainability claims - a growing problem for the modern conscious buyer

We believe true sustainability starts with **TRANSPARENCY & TRACEABILITY**

Our new **IMPACT and CHANGE** collections aim to end greenwashing and lead our industry in a new direction

**AWARE**®

 water.org®

With AWARE™, the use of genuine recycled fabric materials and water reduction impact claims are guaranteed, by using the AWARE disruptive physical tracer and blockchain technology.

With every purchase of IMPACT and CHANGE collection products, **a donation is made to Water.org**, a non-profit that provides access to safe water and sanitation. They have helped **over 36 million** people access safe water to date!

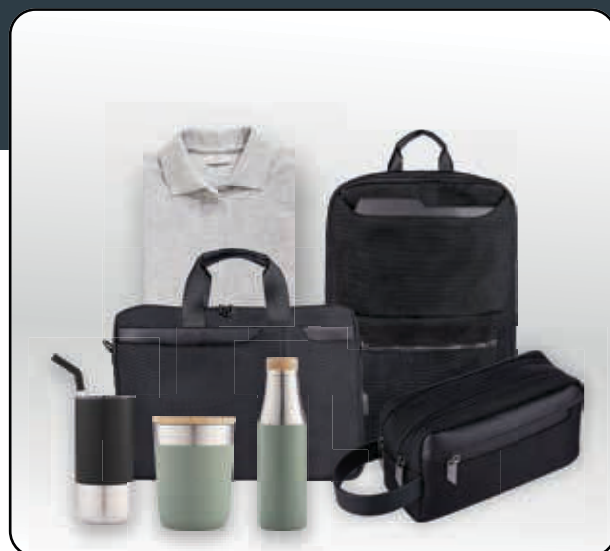

**IMPACT**

**CHANGE.**  
SERIOUS SUSTAINABILITY

*All items made with recycled plastic and recycled cotton, certified by the Global Recycled Standard.*

*CHANGE Collection is about design, serious sustainability and giving back.*

*All recycled content & water saving claims validated with AWARE™ tracer technology*

*All recycled fabrics are certified by the Global Recycled Standard.*

**Gifts that give water:** 2% of sale proceeds from this collection have been donated by Xindao, BV, The Netherlands to Water.org to save lives with safe water

**Gifts that give water:** 3% of sale proceeds from this collection is committed by brand owners to Water.org to save lives with safe water





READY STOCK



## GIFTS THAT GIVE BACK

- 785 million people - 1 in 9 - lack access to safe water. We are supporting Water.org to change this.
- For each CHANGE bottle sold, **3% of sales is donated** by the brand owners to Water.org to save lives with safe water and sanitation.



- > 3% of sales proceeds of each product committed to Water.org
- > 8 hours hot, 24 hours cold
- > Sustainable water bottle and packaging
- > Elegant silicone loop for easy carrying
- > 600ml capacity
- > Scandinavian design

NEBRA

DWHL 516 - Black DWHL 517 - White DWHL 518 - Grey DWHL 519 - Navy Blue

Hans Larsen® Hans Larsen® Nebra Vacuum Insulated Water Bottle is part of the CHANGE Collection, and as a result, contributes to Water.org - a global NGO that provides millions with access to safe water and sanitation. By giving to Water.org, you are giving a GIFT THAT GIVES BACK. Nebra is double walled, leakproof, has a carry loop, stainless steel reusable water bottle with 8 hours hot, and 24 hours cold storage. Scandinavian design. Content: 600ml. Packed in a stylish recycled box that educates about making the Change from single-use to reusable products.

Print Technique : DM

Print Technique : UV, SC, ENG

Product size : ø7.5 X 23 cm

Preferred Print Location : Top of Lid

Preferred Print Location : Front

Packing Details : 51.5 x 32 x 26 cm ; 24 pcs /carton ; gw/nw : 9 kg / carton

Max Print Size : ø50 mm

Max Print Size : (Flat) 140 x 25 mm (Round) 140 x 230 mm



READY STOCK



## STAINLESS STEEL MUG WITH BAMBOO LID

QUALITY

- > 3% of sales proceeds of each product committed to Water.org
- > 15 hours cold, 5 hours hot
- > A Designer Mug that supports Sustainable living
- > Double-Walled
- > SS 304 Inside, SS 201 Outside

### GIFTS THAT GIVE BACK

- 💧 785 million people - 1 in 9 - lack access to safe water. We are supporting Water.org to change this.
- 💧 For each CHANGE mug sold, **3% of sales is donated** by the brand owners to Water.org to save lives with safe water and sanitation.



LAREN

DWHL 334 - White DWHL 333 - Black DWHL 336 - Green DWHL 335 - Blue DWHL 341 - Grey DWHL 342 - Aqua Green

Hans Larsen™ Inspired by Scandinavia, Laren is created for the discerning connoisseur who loves the best. 3% of the sale proceeds go to water.org to change someone's life.

Print Technique : ENG, UV, SC  
Product Size: ø8.5 x 11 cm

Preferred Print Location : Front of Mug & Lid of Mug

Max Print Size : (Front of Mug) 50 x 25 mm (Lid of Mug) ø 80 mm

Packing Details : 55.5 X 28.5 X 27cms ; 36 pcs / carton ; gw / nw : 10.6 / 8.6 kg / carton



Blue

Grey

White

Green

Aqua Green



Black

READY STOCK

## STAINLESS STEEL BOTTLE WITH BAMBOO LID

### QUALITY

- > Double-Walled water bottle
- > SS 304 Inside, SS 201 Outside
- > 560 ml Capacity
- > Vibrant Colors
- > High quality
- > 3% of sales proceeds of each product committed to Water.org
- > 24 hours cold, 8 hours hot

### GIFTS THAT GIVE BACK

- 💧 785 million people - 1 in 9 - lack access to safe water. We are supporting Water.org to change this.
- 💧 For each CHANGE bottle sold, **3% of sales is donated** by the brand owners to Water.org to save lives with safe water and sanitation.



BREDA

DWHL 337 - Black DWHL 338 - White DWHL 339 - Grey DWHL 340 - Blue DWHL 343 - Green DWHL 344 - Aqua Green

Hans Larsen™ Breda is part of Hans Larsen CHANGE. Collection. Proudly use this bottle knowing that you have made a Change in someone's life through our contribution to water.org.

Print Technique : ENG, UV, SC  
Product Size: ø7 x 24.5 cm

Preferred Print Location : Front & Top      Max Print Size : (Front) 120 x 25 mm (Top) ø 40 mm  
Packing Details: 39.5 X 39.5 X 28.5 cms ; 25 pcs / carton ; gw / nw : 9.5 / 7.5 kg / carton



QUALITY



READY STOCK

## STAINLESS STEEL TUMBLER WITH METAL STRAW

- > 3% of sales proceeds of each product committed to Water.org
- > 15 hours cold, 5 hours hot
- > High-end Tumbler with flexible straw
- > Straw Cleaner in high quality stainless steel included
- > 540 ml Capacity
- > Double-Walled
- > SS 304 Inside, SS 201 Outside

### GIFTS THAT GIVE BACK

- 785 million people - 1 in 9 - lack access to safe water. We are supporting Water.org to change this.
- For each CHANGE tumbler sold, **3% of sales is donated** by the brand owners to Water.org to save lives with safe water and sanitation.



BORCULO

DWHL 331 - Black DWHL 332 - White

**Hans Larsen™** Borculo Vacuum Insulated Tumbler with Reusable Straw is part of the CHANGE Collection, and as a result, contributes to Water.org - a global NGO that provides millions with access to safe water and sanitation. By giving to Water.org, you are giving a GIFT THAT GIVES BACK. Borculo is double walled, leakproof, stainless steel reusable coffee tumbler with 5 hours hot, and 15 hours cold storage. Scandinavian design. Includes a reusable straw with a straw cleaner. Content: 540ml. Packed in a stylish recycled box that educates about making the Change from single-use to reusable products.

Print Technique : ENG, UV, SC  
Product Size: ø8 x 17 cm

Preferred Print Location : (Colored Front) (Steel Front) Max Print Size : (Colored Front) 100 x 25 mm (Steel Front) 30 x 25 mm  
Packing Details : 57 X 34 X 25 cms ; 30 pcs / carton ; gw / nw : 10.9 / 8.6 kg / carton



- > Stainless Steel Water Bottle
- > SS 304 Inside, SS 201 Outside
- > Double Walled Vacuum
- > 24 Hours Cold & 8 Hours Hot
- > Leak Proof
- > Screw-On Cap; BPA Free
- > 500 ml Capacity

READY STOCK



Black

White



HUNFELD

DWHL 280 - Black DWHL 281 - White

Hans Larsen™ CHANGE Double Walled Stainless Steel Vacuum Water Bottle (500ml). This bottle makes an impact by supporting Water.org to provide safe water to people in need with every purchase. Packed in an elegant recycled gift box.

Print Technique : UV, SC, ENG

Preferred Print Location : Front

Max Print Size : 110 X 20 mm

Product size : ø 6.8 x 26 cm

Packing Details : 45 x 30.5 x 28.4 cm ; 24 pcs /carton ; gw/nw: 6.5/8 kg/ carton



### GIFTS THAT GIVE BACK

785 million people - 1 in 9 - lack access to safe water. We are supporting Water.org to change this.

For each CHANGE bottle sold, **3% of sales is donated** by the brand owners to Water.org to save lives with safe water and sanitation.



1 Ocean bottle = 1000 Ocean - Bound Plastic Bottles Collected



SMALL BOTTLE

**BIG  
IMPACT**



*"Ocean bottle is the first tangible ocean impact we have"*

London  
**Evening  
Standard**

*"If Apple designed a drinks container for life, this would be it."*

  
**THE TIMES**

*"Fighting plastic pollution at a grassroots level"*

**Forbes**



ORACLE  
Red Bull RACING

WHY OCEAN BOTTLE?

• Oracle Red Bull Racing utilised Ocean Bottle to create a world leading plastic Corporate Social Responsibility programme in line with their carbon reduction and offset schemes



COMPANY GIFTING



24,000,000 PLASTIC BOTTLES COLLECTED



23,936 OCEAN BOTTLES PURCHASED



272,000 KGS OF OCEAN PLASTIC COLLECTED

webexone

WHY OCEAN BOTTLE?

- Used Ocean Bottle Plastic Collection Certificates in Annual Report
- Used the Bottles as a communications tool to tell their Employees about the impact they created
- Shared OB's Welcome Pack with each recipient



COMPANY GIFTING



7,125,000 PLASTIC BOTTLES COLLECTED



7,125 OCEAN BOTTLES PURCHASED



81,225 KGS OF OCEAN PLASTIC COLLECTED



WHY OCEAN BOTTLE?

Mercedes-Benz Global HQ bought 4100 Ocean Bottles for giveaways at their corporate events, such as their Golf Events & their track driving days for **prospective clients**

Events Include:

- Ladies Business Cup
- AWGC Tour
- Mercedes Trophy Golf
- Mercedes-AMG Track days



COMPANY GIFTING



4,100,000 PLASTIC BOTTLES COLLECTED



4,100 OCEAN BOTTLES PURCHASED



46,740 KGS OF OCEAN PLASTIC COLLECTED





# Corporate's Certificate (example)



IMPACT CERTIFICATE

FOR PREVENTING  
**46,609 KGS**

FROM ENTERING OUR OCEAN.

POWERED BY IBM BLOCKCHAIN+



ISO 17033 Ethical Claims Verified  
26000 Social Responsibility Verified  
SEDEX Compliant



Will Pearson  
CEO & Co-Founder

Nick Doman  
COO & Co-Founder

January 2021  
[www.oceanbottle.co](http://www.oceanbottle.co)  
[@oceanbottle](https://twitter.com/oceanbottle)

READY STOCK

## SUSTAINABLE FROM THE START

- Our packaging is **FSC certified, recycled** and **recyclable**
- **Designed to ship** without the need for useless plastic sleeves
- Interactive packaging that tells the brand and product mission.
- Customisable







# OUR HERO PRODUCT & AWARDS

Made from **insulated stainless steel** and **recycled ocean bound plastic**.

Designed in Norway by award winning **K8 Industridesign**, developing the bottle from user insight all the way to our **award winning** final product.



## MORE THAN JUST A BOTTLE

### Value add benefits

- Each Ocean Bottle funds the collection of **1000 ocean-bound plastic bottles** in weight & improves social mobility
- Receive **collector** stories and **content**
- Company plastic collection **impact certificate**
- **Co-founder talks** or panel for your audience
- **PR support** with messaging and communications
- **Branding opportunity** on merchandise
- Each Ocean Bottle is entirely **carbon neutral**, offsetting **4.88kg of carbon** (per unit sold)



1 FOR 1000 // 1 FOR 1000 // 1 FOR 1000 // 1 FOR 1000 // 1 FOR 1000 // 1 FOR 1000 // 1 FOR 1000 //

## SOCIAL IMPACT

We work with individuals all over the world, wherever plastic pollution is worst, to stop the flow at its source.

Collectors exchange plastic for **money** and get access to **social resources** such as **healthcare, education, mental health support** and **financial security**

All enabled by our network of plastic collection partners.





# SERIOUSLY SUSTAINABLE DRINKWARE

500 ML

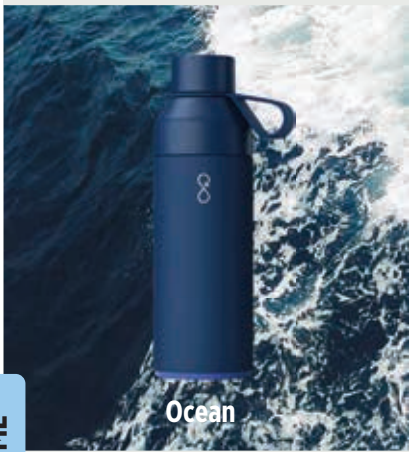

Ocean



Rock



Forest



Sky

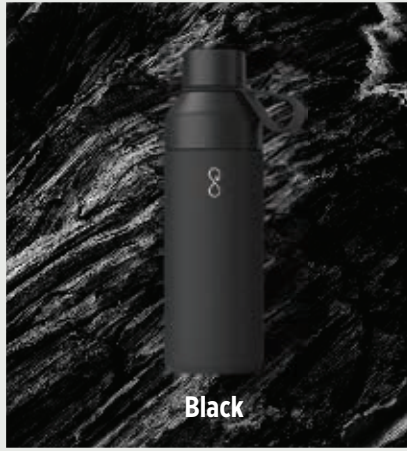

Black



Sun

READY STOCK

Scan Below QR code to watch product video



BESPOKE EXAMPLE



- > Reusable bottle that funds the collection of 1000 plastic bottles in weight
- > Dishwasher safe
- > 180° twist anti-leak lid with dual opening for drinking and easy cleaning
- > Vacuum stainless steel insulation keeping hot things hot and cold things cold
- > Ice, coffee, tea, juice, smoothies, still and sparkling water — it's all good

## OCEAN BOTTLE

DWOB 291 - Black   DWOB 292 - Ocean   DWOB 293 - Sun   DWOB 294 - Sky   DWOB 295 - Forest   DWOB 296 - Rock

Our original award-winning 500ml Ocean Bottle keeps cold drinks cold, and hot drinks hot. Made from double wall vacuum-insulated stainless steel and recycled content. The anti-leak dual opening lid makes filling and cleaning a breeze. Plus, unlike most reusable bottles, Ocean Bottle is 100% dishwasher safe.

Available in six colours: Ocean Blue, Rock Grey, Sun Orange, Forest Green, Obsidian Black and Sky Blue.

Print Technique : SC, UV, ENG

Preferred Print Location : Front

Max Print Size : 120 X 25 mm

Product Size : 22 X ø 6.8 cm

Packing Details : 49 X 34 X 27 cm ; 24 pcs / carton ; gw / nw : 10 kg / carton



1000 ML



Black



Ocean



Rock

Meet BOB.

# THIRSTY FOR MORE?

Scan Below QR code to watch product video

READY STOCK

EACH BOB FUNDS THE COLLECTION OF 1,000 PLASTIC BOTTLES, 11.4KGS OF PLASTIC

**1 LITRE**

- Hot and Cold stainless steel vacuum insulation up to 18 hours
- No sweat exterior
- Recycled ocean-bound plastic base
- NFC Smart Chip Enabled to collect more plastic with every refill
- Dual opening for easy fill, clean and ice
- Dishwasher Safe BPA free
- Anti-leak seal 180 twist cap
- Easy carry loop
- Drinking Cup

Meet BOB.

The award-winning Ocean Bottle just a lot bigger. Because bigger is better when it comes to hydration. BOB is perfect for the car, on your desk or for a family sharing.

1 Big Ocean Bottle collects 1000 plastic bottles and improves livelihoods in coastal communities.

BIG OCEAN BOTTLE

DWOB 297 - Black DWOB 298 - Rock DWOB 299 - Ocean

Our award-winning 1000ml Big Ocean Bottle keeps cold drinks cold, and hot drinks hot. Made from double wall vacuum-insulated stainless steel and recycled content. The anti-leak dual opening lid makes filling and cleaning a breeze. Plus, unlike most reusable bottles, Big Ocean Bottle is 100% dishwasher safe.

Available in three colours: Ocean Blue, Rock Grey and Obsidian Black.

Print Technique : SC, UV, ENG Preferred Print Location : Front Max Print Size: 175 X 30 mm

Product Size : 26.4 X ø 8.5 cm



## SERIOUSLY SUSTAINABLE FLASK

EACH BREW FLASK FUNDS THE **COLLECTION OF 1,000 PLASTIC BOTTLES, 11.4KGS OF PLASTIC.**

**EASY SWAP LID** - If you have an Ocean Bottle you can swap the Brew lid with the Original to suit different needs and occasions

**KEEPS STUFF HOT** - Thermal lid and double-insulation keep drinks how you like them up to 6 hours

**TWIST TO LOCK LID** - The simple 180 twist lid mechanic means you can seamlessly lock the lid or unlock it

**360 LID LETS DRINKS FLOW** - Feels like drinking from your favourite cup and lets the coffee flow and circulate

**NFC ENABLED** - So you can collect more plastic every time you refill

**LEAK PROOF** - Leak-free lid and sweat-free surface keep wet stuff safely on the inside

**LASTS A LIFETIME** - designed for durability, recyclable 'til the end



READY STOCK



Coffee on the go never tasted so good.

Brew is designed to be the only drink companion you need when you're on the **go**.

With a **360° lid**, it feels like you're drinking from your favourite cup, and let's the coffee flow and aromas circulate.

Our brew flasks are made from **99%** recycled stainless steel double wall vacuum-insulated recycled materials, won't leak or sweat in your bag and are **100%** dishwasher safe – all while helping to **save the ocean, every Brew funds the collection of 1000 plastic bottles.**





Sun



Sky



Forest



Ocean



Rock



Black



Scan QR code to watch product video



**A HOT / COLD BEVERAGE CONTAINER FROM THE OCEAN BOTTLE FAMILY**

- > Reusable Mug that funds the collection of 1000 plastic bottles in weight
- > Dishwasher safe
- > 360° twist anti-leak lid with for ultimate drinking convenience
- > Vacuum stainless steel insulation keeping hot things hot and cold things cold

**READY STOCK**

BREW

DWOB 3121 - Black DWOB 3122 - Ocean DWOB 3123 - Sun DWOB 3124 - Sky DWOB 3125 - Forest DWOB 3126 - Rock

The new 350ml Ocean Bottle-BREW keeps cold drinks cold, and hot drinks hot. Made from double wall vacuum-insulated stainless steel and recycled content.

The anti-leak dual opening lid makes filling and cleaning a breeze. Plus, unlike most reusable Flasks/Mugs, Ocean Bottle is 100% dishwasher safe.

Available in six colours: Ocean Blue, Rock Grey, Sun Orange, Forest Green, Obsidian Black and Sky Blue.

Print Technique : SC, UV, ENG Preferred Print Location : Front Max Print Size: 115 X 25 mm

Product Size : 17 X ø6.8 cm



Useful eco-conscious gift set with sustainable packaging:

**Notebook** - Kraft cover with FSC-certified paper inside

**Mug** - Wheatstraw material with silicone sleeve

**Pen** - Made with wheatstraw material

VALUE

READY STOCK



WHEAT STRAW

Wheatstraw Mug w/ silicone



Notebook with FSC paper



WHEAT STRAW

Wheatstraw Pen

- All products plus packaging from sustainable materials
- Silicone sleeve helps hold mug with hot liquid
- 80 pgs Notebook - 14 x 9 cm, 70 gsm
- Give VALUE, Save Ecology when you give out this set
- 380 ml Mug capacity



GSEN 681 - KORGAN

(Notebook) Print Technique : SC, UV

(Pen) Print Technique : SC, UV

(Mug) Print Technique : SC

Box Size: 14.5 x 10.3 x 9.7 cm; Each set of 3 in box weighs 176 gms

Preferred Print Location : Front

Preferred Print Location : Clip

Preferred Print Location : Front

Max Print Size : 70 x 130 mm

Max Print Size : 7 x 35 mm

Max Print Size : 30 x 50 mm



READY STOCK



Bamboo & Packaging-  
sustainable

Set of Eco Lunch Box & Vacuum Bottle  
GSHL 180 - CHAVES

Hans Larsen® (BOTTLE) Double wall stainless steel insulating vacuum flask with bamboo lid and carry handle. Capacity: 500 ml. Leak Proof Material- SS 304 Inside SS 201 Outside.  
(LUNCH BOX) Stainless Steel lunchbox with bamboo lid and 2 cutlery utensils with attachable polyester band. Capacity 700ml. Bamboo is a natural product, there may be slight variations in colour and size per item. Material- SS 304 Food Grade

(BOTTLE) Print Technique : SC, UV, ENG Preferred Print Location : Bottle Front & Top  
(LUNCH BOX) Print Technique : SC, ENG Preferred Print Location : Lunch Box Top & Side  
Box Size : 25.5 x 25.5 x 7.5 cm; Box with both items weighs 715 gms

Max Print Size : (Front) 30 x 40 mm (Top) ø 45 mm  
Max Print Size : (Top) 90 x 30 mm (Side) 30 x 100 mm



# ECO FRIENDLY WATER BOTTLES



- Glass Inside
- ECO Wheat Straw Exterior
- Phone Stand
- 380 ml Bottle with carry handle



Mobile Stand

DWGL 361 - RABI

**eco-neutral** Eco Friendly water bottle with glass interior and wheat straw exterior. With convenient handle for easy carrying and a phone stand at the base. Capacity 380ml. BPA free. Packed in a gift box.

Print Technique : UV, SC, ENG  
Product Size : 21 x ø6.3cm

Preferred Print Location : Front Max Print Size : (Flat)30 X 100 mm; (Round) 100 X 190 mm  
Packing Details : 56 x 35.5 x 23.5 cm; 40 pcs/carton ; gw/nw: 13/12 kg / carton

READY STOCK



Made from natural fast growing bamboo and 100% recyclable borosilicate glass, this reusable bottle is designed to support the environment.



- Borosilicate Glass Body & Eco Bamboo Top Cap
- Silicon Sleeve For Protection
- Eco-Friendly !!



Hans Larsen™



DWHL 502 - MEGARA

**Hans Larsen** Megara is made from glass that is 100% recyclable and that doesn't infuse harmful chemicals or unwanted flavours into your water like plastic or metal and eco-friendly bamboo lid. Made from high grade borosilicate glass, which is more heat resistant than any other commonly used glass. Now you can save the planet and enjoy your warm tea too. With fashionable silicone sleeve for drop protection and heat insulation. Content 550ml.

Print Technique : UV, SC, ENG  
Product Size : 24 x ø6.8 cm

Preferred Print Location : Top Max Print Size : 45 x 40 mm  
Packing Details : 49 X 33 X 26 cm; 24 pcs/carton; gw/nw: 14.5 kg/carton





- > Made from borosilicate glass to hold hot and cold liquids
- > Glass decanter with cork lid
- > Contemporary design
- > 600ml capacity



600 ml



DWEN 362 - BERKA

**eco-neutral** Borosilicate glass bottle with a cork lid. Store your fresh made juices, water or other drinks in this glass bottle. Because it is made from borosilicate glass, it can also hold hot liquids. The cork lid gives the decanter a natural look. Capacity: 600 ml.  
 Print Technique : UV, SC Preferred Print Location : Front  
 Max Print Size : (Flat) 150 X 25 mm (Round) 223 X 150 mm  
 Product Size : 23 x ø7.1 cm



- > Made from borosilicate glass to hold hot and cold liquids
- > Glass decanter with cork lid
- > Contemporary design
- > 1000ml capacity

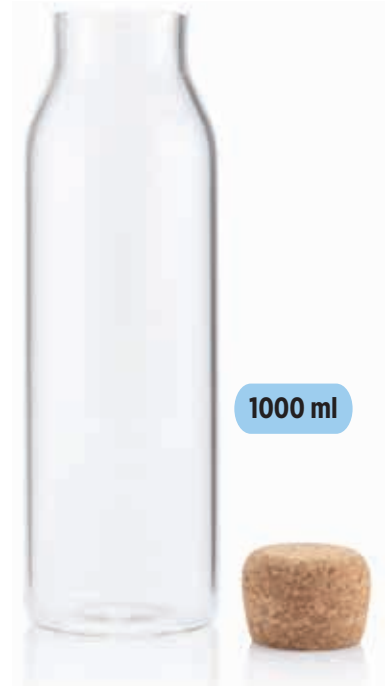

1000 ml



DWEN 363 - DELLACH

**eco-neutral** Borosilicate glass bottle with a cork lid. Store your fresh made juices, water or other drinks in this glass bottle. Because it is made from borosilicate glass, it can also hold hot liquids. The cork lid gives the decanter a natural look. Capacity: 1L.  
 Print Technique : UV, SC Preferred Print Location : Front  
 Max Print Size : (Flat) 190 X 30 mm (Round) 267 X 190 mm  
 Product Size : 29.4 x ø8.5 cm

READY STOCK



# BIO BOTTLES MADE IN THE NETHERLANDS

# Tacx

BIO BOTTLES MADE IN THE NETHERLANDS

**Tacx** Are you looking for a bottle fully made of biodegradable materials? Then the Bio-Bottle of Tacx is a great choice. It stands out because the plastic of the bottle is biodegradable. Adding a small amount of bio-material changes the molecular structure so the material finally breaks up in biogas and biomass. This feeds the soil and it's completely absorbed by nature. The process of disintegration starts when the bottle ends up at a microbiological environment (compost heap, waste disposal).

## Made in THE NETHERLANDS

- Bio Degradable
- 100% Recyclable
- Safe for Food Use
- Screw-On Cap With A Leak Proof Spout
- Secure Grip On Triangular Cap For Easy - Opening And Closing Of Bottle
- Certified Bio-Degradable Water Bottles.
- FDA Approved For Contact With Food.
- OSHA Approved As Non-Hazardous.
- Indefinite Shelf Life.



**WB 003**  
Transparent / Aqua Lid  
750CC



**WB 003**  
Silver - 750CC



**WB 003**  
Transparent / Red Lid 750CC



**WB 003**  
Transparent / Purple Lid 750CC



**WB 003**  
Transparent / Blue Lid 750CC



**WB 003**  
Transparent / Pink Lid 750CC



**WB 003**  
Transparent / Grey Lid 750CC



**WB 003**  
Transparent / Royal Blue Lid 750CC

## Stocks Available



**WB 002**  
Full Red  
500CC



**WB 002**  
Full White  
500CC



**WB 002**  
White/  
Blue Lid  
500CC

Print Technique : UV, SC Preferred Print Location : Center  
Max Print Size : (Flat) 33 x 50 mm, 230 x 50 mm ( Round )  
Product Size 500CC : ø7.7 x 19.6 cm  
Packing Details : 38 x 38 x 39 cm ; 50 pcs /carton ; gw/nw: 4.40 kg / carton



Print Technique : UV, SC  
Product Size 750CC: ø7.7 x 25 cm

Preferred Print Location : Center Max Print Size : (Flat) 33 x 100 mm, 230 x 100 mm ( Round )  
Packing Details : 39 x 39 x 52 cm ; 50 pcs /carton ; gw/nw: 5.5 kg / carton

READY STOCK



Navy Blue

White

Black

**SAY NO TO GREENWASHING**

*Tell the true story of sustainability with genuine recycled rPET and cotton with validated claims.*

Certified by Global Recycled Standard

**GIFTS THAT GIVE BACK**

785 million people - 1 in 9 - lack access to safe water. We are supporting Water.org to change this.

For each IMPACT cap sold, 2% of sales is donated by the Xindao B.V. (Netherlands) to Water.org to save lives with safe water and sanitation.



READY STOCK

- > 2% of sales proceeds of each product committed to Water.org
- > Made of 100% recycled materials

- > Made with AWARE™ tracer
- > This cap saved 387 litres of water



280 gr Recycled Cotton Cap with Aware Tracker - XD Impact Collection

HWAW 451 - Black HWAW 452 - White HWAW 453 - Navy Blue

**XD COLLECTION** No greenwashing, but telling a true story about sustainability! This Impact collection is made with AWARE™ tracer. With AWARE™, the use of genuine recycled fabric materials and water reduction impact claims are guaranteed by using the AWARE disruptive physical tracer and blockchain technology. Save water and use genuine recycled fabrics. With the focus on water 2% of proceeds of sold Impact product has been donated to Water.org. This cap has saved 387 litres of water. A simple and comfortable cap suited for anyone. This 6 panel cap has a curved visor, embroidered eyelets for ventilation and metal buckle. Cotton twill made of 100% recycled materials and AWARE™ tracer. The material weight is 280 g/m2. Size 58cm.

Print Technique : HT, SC, EMBROIDERY  
Product Size: 58 cm

Preferred Print Location : Front  
Packing Details : 36.5 X 45.5 X 69.5 cms ; 200 pcs / carton ; gw / nw : 17 kg / carton

Max Print Size : 45 x 35 mm

# Recycled Polo

## Our Transparent Process

**COLLECTION**  
of plastic bottles,  
removing labels & foreign materials,  
making it process - ready



**COLLECTION**  
of cotton fabric waste,  
also called post-industrial  
cotton waste, making it  
process-ready



**SHREDDING**  
Used water bottles into  
fiber, certified by the  
Global Recycled Standard



**SHREDDING**  
post-industrial cotton waste  
into fiber, certified by the  
Global Recycled Standard



**YARNS**  
produced by spinning the fiber



**YARNS**  
produced by spinning the  
fiber



**FABRIC**  
produced by using cotton &  
plastic yarns together



**APPAREL**  
produced from the Recycled fabric,  
certified by the Global Recycled Standard



**VERIFICATION DOCUMENT**  
available, as the above process is  
entirely transparent

**GREENWASHING DISCOURAGED**  
by using above verifiable process,  
ensuring positive impact on  
environment



**PLEGGED DONATION**  
of 3% of sales proceeds to  
water.org ensures safe water  
& sanitation to the needy



**Plastic Bottles**  
recycled, positive impact



**RECYCLED COTTON**  
ensures fresh cotton is  
not used, positive impact



**WATER SAVINGS**  
as fresh cotton fabric  
production consumes  
huge quantities of water



SANTHOME

**PRO EARTH**  
SHIRT IS MADE FROM  
17 PLASTIC BOTTLES



THIS SHIRT HAS SAVED  
1,260L OF WATER

SANTHOME

**PRO EARTH**  
FULLY RECYCLED POLO

MADE FROM  
60% RECYCLED COTTON  
AND 40% RECYCLED PET





The PRO EARTH Polos from Santhome use

LESS WATER • LESS CHEMICALS • LESS EMISSION • LESS ENERGY • LESS WASTE • REDUCE CARBON FOOTPRINT



Navy Blue



White



READY STOCK



Black

-1,260L

17

> 3% of sales proceeds of this Polo committed to Water.org by the brand owners

Item : PRO Earth Polo

Content : 40% Recycled PET, 60 % Recycled Cotton

Measurement : Gulf Sizes

Sizes Available : S- XXXL

Care Instructions:

Print Technique :

- 1 Screen Printing
- 2 Heat Transfer
- 3 Embroidery

Preferred Print Location : Max Print Size:  
Left Chest Area / Sleeve 80 x 50 mm

PRO EARTH POLO

**CHANGE.**  
SERIOUS SUSTAINABILITY

THIS SHIRT IS MADE FROM 17 PLASTIC BOTTLES

THIS SHIRT HAS SAVED 1,260L OF WATER

SANTHOME

**PRO EARTH**  
FULLY RECYCLED POLO

MADE FROM 60% RECYCLED COTTON AND 40% RECYCLED PET

**THE GIFT OF WATER**

For each product sold, the brand owner will donate 3% of sales to support Water.org to change lives with safe water and sanitation

a US-based 501(c)(3) global non-profit organization

**785M**

785 million people - 1 in 9 - lack access to safe water

We are supporting Water.org to change this



READY STOCK





Grey



Black

**SAY NO TO GREENWASHING**

*Tell the true story of sustainability with genuine recycled rPET*

Certified by



**GIFTS THAT GIVE BACK**

785 million people - 1 in 9 - lack access to safe water. We are supporting Water.org to change this.

For each CHANGE product sold, 3% of sales is donated by the brand owners to Water.org to save lives with safe water and sanitation



READY STOCK



- Trendy 2-in-1 design for laptop sleeve and workstation
- Lifts laptops 6 cms for better work comfort
- Versatile pockets in the back
- Portable and easy to carry
- Uses high quality magnets for the cover and laptop stand



FULDA

LSSN 411 - Black LSSN 412 - Grey

SANTHOME Santhome Fulda - CHANGE Collection 15.6" Laptop Case & Workstation is a trendy and practical 2-in-1 laptop sleeve and workstation made from GRS-certified RPET and stylish faux leather. The laptop sleeve easily converts into a mobile office with laptop stand so you can work anywhere comfortably. Stay organised with the additional sleeve pockets and pen loops that allows you to take your other office essentials with you. Each recycled bag saves 2.5L of water, reuses 3 plastic bottles and makes an impact by contributing to Water.org - a global NGO that provides millions in need with access to safe water and sanitation. By giving to Water.org, you are giving a GIFT THAT GIVES BACK.

Print Technique : SC

Preferred Print Location : Front

Max Print Size : 120 x 100 mm

Product size : 27 X 16 X 7 cm

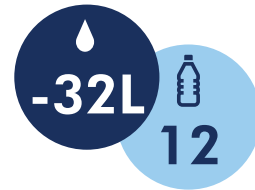

READY STOCK

- > Made from Recycled PET fabric certified by Global Recycled Standards
- > 3% of sales proceeds of each product is committed to Water.org
- > This bag saved 32 liters of water
- > Back trolley strap to attach backpack to trolley bag
- > This Bag is made by recycling 12 plastic bottles

### SAY NO TO GREENWASHING

**Tell the true story of sustainability with genuine recycled rPET**

Certified by



### GIFTS THAT GIVE BACK

- 💧 785 million people - 1 in 9 - lack access to safe water. We are supporting Water.org to change this.
- 💧 For each CHANGE bag sold, 3% of sales is donated by brand owners to Water.org to save lives with safe water and sanitation.



MBSN 972 - OIKOS

SANTHOME CHANGE Laptop Office Bag made from high-end durable 1680D recycled rPET (certified by GRS) and stylish leather components. Convenience pockets in the front for quick access of mobile phones, documents, etc. Each bag saves 32L of water, reuses 12 plastic bottles and makes an impact by supporting Water.org to provide safe water to people in need with each purchase.

Print Technique : SC

Preferred Print Location : Front

Max Print Size : 170 X 200 mm

Product size : 38 x 28 x 7 cm

Packing Details : 69 x 60 x 49 cm ; 6 pcs /carton ; gw/nw: 10.9 kg/ carton





**SAY NO TO GREENWASHING**

*Tell the true story of sustainability with genuine recycled rPET and cotton with validated claims.*

Certified by Global Recycled Standard

**GIFTS THAT GIVE BACK**

- 💧 785 million people - 1 in 9 - lack access to safe water. We are supporting Water.org to change this.
- 💧 For each IMPACT bag sold, **2% of sales is donated** by the Xindao B.V. (Netherlands) to Water.org to save lives with safe water and sanitation.



**-15L** **26**

**READY STOCK**

- > 2% of proceeds of each product donated to Water.org
- > This bag is made of 26 recycled bottles
- > Made with AWARE™ tracer
- > This bag saved 15 liters of water

MBAW 461 - Black MBAW 462 - Navy Blue

**XD COLLECTION** No greenwashing, but telling a true story about sustainability! This Impact collection is made with AWARE™ tracer. With AWARE™, the use of genuine recycled fabric materials and water reduction impact claims are guaranteed, by using the AWARE disruptive physical tracer and blockchain technology. Save water and use genuine recycled fabrics. If you choose this item you save 15 litres of water and 26 plastic bottles have been reused. With the focus on water, 2% of proceeds of each Impact product sold is donated to Water.org. Casually professional and organised, the Impact 15.6" laptop bag is made for the modern professional with an eye for value and the environment. It features a classic design with front accent stitching, multiple storage pockets, two top handles, and an adjustable, detachable shoulder strap. The outer fabric and inner lining consist of 100% recycled polyester with AWARE™ tracer. PVC free.

Print Technique : SC Preferred Print Location : Front Max Print Size : 180 x 30 mm  
Product Size : 28 x 6 x 39.5 cm Packing Details : 49.5 X 38.5 X 48.5 cms ; 12 pcs / carton ; gw / nw : 5.5 kg / carton



**IMPACT**

AWARE™ RPET WEEKEND DUFFLE BAG

XD COLLECTION

**SAY NO TO GREENWASHING**

*Tell the true story of sustainability with genuine recycled rPET and cotton with validated claims.*

Certified by



**GIFTS THAT GIVE BACK**

785 million people - 1 in 9 - lack access to safe water. We are supporting Water.org to change this.

For each IMPACT bag sold, 2% of sales is donated by the Xindao B.V. (Netherlands) to Water.org to save lives with safe water and sanitation.



READY STOCK

- 2% of proceeds of each product committed to Water.org
- This bag is made of 45 recycled bottles
- Made with AWARE™ tracer
- This bag saved 27 liters of water



DBAW 457 - DUFFLE BAG

**XDDESIGN** No greenwashing, but telling a true story about sustainability! This Impact collection is made with AWARE™ tracer. With AWARE™, the use of genuine recycled fabric materials and water reduction impact claims are guaranteed, by using the AWARE disruptive physical tracer and blockchain technology. Save water and use genuine recycled fabrics. If you choose this item you save 27 litres of water and 45 plastic bottles have been reused. With the focus on water, 2% of proceeds of each Impact product sold is donated to Water.org. The AWARE™ weekend duffle impresses with its modern and simple look. Its clean design makes the duffle ideal for travel. The roomy main compartment offers plenty of space for your essentials. Two mesh pockets make your smaller items easy to find. The front zipper pockets have 2 sleeve pockets and 2 pen loops. Interior and exterior 100% recycled polyester with AWARE™ tracer. PVC free.

Print Technique : SC

Preferred Print Location : Front

Max Print Size : 250 x 35 mm

Product Size: 32 x 22 x 55 cm

Packing Details : 43 X 36 X 59 cms ; 15 pcs / carton ; gw / nw : 11.5 kg / carton



- > Made from Recycled PET fabric certified by Global Recycled Standards
- > 3% of sales proceeds of each product is committed to Water.org
- > High-end Sustainable
- > This bag saved 43 liters of water
- > This Bag is made by recycling 17 plastic bottles



**GO directly to office from gym -  
Go directly to gym from office**

**AN EXECUTIVE  
Duffel Bag**

**SAY NO TO GREENWASHING**

*Tell the true story of sustainability with genuine recycled rPET*

**Certified by**



**GIFTS THAT GIVE BACK**

785 million people - 1 in 9 - lack access to safe water. We are supporting Water.org to change this.

For each CHANGE bag sold, 3% of sales is donated by brand owners to Water.org to save lives with safe water and sanitation.



**READY STOCK**



**DBSN 661 - PEGEIA**

SANTHOME CHANGE Duffel / Weekender / Gym Bag made from high-end durable 1680D recycled rPET (certified by GRS) and stylish leather components. Includes special shoe compartment. Each bag saves 43L of water and reuses 17 plastic bottles, while supporting Water.org to provide safe water to people in need with each purchase.

Print Technique : SC, HT

Preferred Print Location : Pocket

Max Print Size : 100 X 200 mm

Product size : 54 x 26 x 25 cm



- > High end - Sustainable Travel accessory
- > Made from GRS-Certified Recycled Fabric
- > This Bag saved 10 litres of water
- > This Bag is made by recycling 4 plastic bottles

HPSN 551 - TRIKOMO

SANTHOME CHANGE Wash Bag / Toiletries Pouch - made with high-end durable 1680D recycled rPET (certified by GRS) and stylish leather components. Get your essentials organized while supporting Water.org to provide safe water to people in need with each purchase. Each bag saves 10L of water and reuses 4 plastic bottles

Print Technique : SC Preferred Print Location : Front Max Print Size : 110 x 50 mm

Product size : 23 X 14 X 10.5 cm

**SAY NO TO GREENWASHING**

*Tell the true story of sustainability with genuine recycled rPET*

Certified by



**GIFTS THAT GIVE BACK**

785 million people - 1 in 9 - lack access to safe water. We are supporting Water.org to change this.

For each CHANGE bag sold, 3% of sales is donated by brand owners to Water.org to save lives with safe water and sanitation.



READY STOCK



- > High end - Sustainable Travel accessory
- > Made from GRS-Certified Recycled Fabric
- > This Bag saved 9 litres of water
- > This Bag is made by recycling 4 plastic bottles



HPSN 552 - POMOS

SANTHOME CHANGE Technology Accessories Kit - made with high-end durable 1680D recycled rPET (certified by GRS) and stylish leather components. Organizes all tech accessories (like cables, chargers, power banks, adapters, etc.). Great for office or travel. Each bag saves 9L of water and reuses 4 plastic bottles, while supporting Water.org to provide safe water to people in need with each purchase.

Print Technique : SC

Preferred Print Location : Front

Max Print Size : 120 x 100 mm

Product size : 27 X 16 X 7 cm



- > Made from Recycled PET fabric certified by Global Recycled Standards
- > 3% of sales proceeds of each product is committed to Water.org
- > This bag saved 35 liters of water
- > This Bag is made by recycling 14 plastic bottles
- > Expandable zipper adds additional storage
- > Back trolley strap to attach backpack to trolley bag

-35L 14

**SAY NO TO GREENWASHING**

*Tell the true story of sustainability with genuine recycled rPET*

Certified by

**GIFTS THAT GIVE BACK**

- 💧 785 million people - 1 in 9 - lack access to safe water. We are supporting Water.org to change this.
- 💧 For each CHANGE bag sold, **3% of sales is donated** by the brand owner to Water.org to save lives with safe water and sanitation.



**READY STOCK**



Excellent storage space



Trolley Strap for attaching to trolley bag



Expandable Zipper

**BPSN 796 - MARGO**

SANTHOME CHANGE Laptop Backpack made from high-end durable 1680 recycled rPET (certified by GRS) and stylish leather components. Elegant executive design. Extra zipper provided expandable storage space. Each bag saves 35L of water and reuses 14 plastic bottles, while supporting Water.org to provide safe water to people in need with each purchase.

Print Technique : SC

Preferred Print Location : Front Top & Bottom

Max Print Size : 100 X 130 mm

Product size : 44 x 30 x 13 cm (Expanded) 44 x 30 x 17 cm

Packing Details : 69 x 60 x 49 cm ; 6 pcs /carton ; gw/nw: 10.9 kg/ carton

SANTHOME

**CHANGE.**  
SERIOUS SUSTAINABILITY





**SAY NO TO GREENWASHING**

*Tell the true story of sustainability with genuine recycled rPET*

**Certified by** Global Recycled Standard

**GIFTS THAT GIVE BACK**

💧 785 million people - 1 in 9 - lack access to safe water. We are supporting Water.org to change this.

💧 For each CHANGE bag sold, **3% of sales is donated** by the brand owner to Water.org to save lives with safe water and sanitation.



- > Made from RPET fabric, certified by Global Recycled Standard (GRS)
- > Elegant slim design, perfect for commuters
- > 3% of sales proceeds of each product is committed to Water.org
- > This bag has saved 16 liters of water
- > This bag is made from reusing 6 plastic bottles

**READY STOCK**



**-16L** **6**

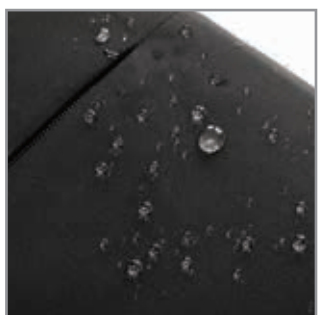

**BPSN 2103 - SANOK**

SANTHOME CHANGE 15.6" Slim Commuter Laptop Backpack made from premium durable recycled PET (rPET), certified by the Global Recycled Standard (GRS). Elegant executive design and stylish fittings. Each bag saves 16L of water and reuses 6 plastic bottles, while supporting Water.org to provide safe water to people in need with each purchase.

Print Technique : SC

Preferred Print Location : Front

Max Print Size : 200 x 150 mm

Product Size: 45 X 31 X 8 cm







READY STOCK

- > 2% of proceeds of each product donated to Water.org
- > This bag is made of 33 recycled bottles
- > Made with AWARE™ tracer
- > This bag saved 19 liters of water

-19L 33

<p><b>SAY NO TO GREENWASHING</b></p> <p><i>Tell the true story of sustainability with genuine recycled rPET and cotton with validated claims.</i></p> <p><b>Certified by</b> </p>	<p><b>GIFTS THAT GIVE BACK</b></p> <ul style="list-style-type: none"> <li> 785 million people - 1 in 9 - lack access to safe water. We are supporting Water.org to change this.</li> <li> For each IMPACT bag sold, 2% of sales is donated by the Xindao B.V. (Netherlands) to Water.org to save lives with safe water and sanitation.</li> </ul> <p> <b>IMPACT</b></p>
---	---

BGAW 458 - Black    BGAW 459 - Anthracite    BGAW 460 - Navy Blue

**XD COLLECTION** No greenwashing, but telling a true story about sustainability! This Impact collection is made with AWARE™ tracer. With AWARE™, the use of genuine recycled fabric materials and water reduction impact claims are guaranteed, by using the AWARE disruptive physical tracer and blockchain technology. Save water and use genuine recycled fabrics. If you choose this item you save 19 litres of water and 33 plastic bottles have been reused. With the focus on water, 2% of proceeds of each Impact product sold has been donated to Water.org. The streamlined AWARE™ 15.6" laptop backpack includes a laptop sleeve in the main compartment and an inside sleeve pocket with 2 pen loops. A separate front zipper pocket can hold your small daily essentials. Interior and exterior 100% recycled polyester with AWARE™ tracer . PVC free.

Print Technique : SC                      Preferred Print Location : Front                      Max Print Size: 180 X 40 mm  
 Product Size : 44.5 X 12 X 30.5 cm                      Packing Details : 49.5 X 38.5 X 48.5 cm ; 12 pcs / carton ; gw / nw : 5.5 kg / carton

XDDESIGN

# BOBBY SOFT

Anti - Theft Backpack





A new take on the ORIGINAL Bobby Anti-theft Backpack

Scan Below QR  
code to watch  
product video



Black



Navy Blue



Grey

- > Iconic Bobby antitheft design
- > Made from Recycled PET and AWARE® tracer
- > Each Bobby Soft saves 23L of water and reuses 39 plastic bottles

READY STOCK



ORGANISER PANEL AND INTERNAL POCKETS



INTEGRATED USB CHARGING PORT



SAFE ZIPPER PULLER



EXPANDABLE TOP



BOBBY SOFT

BGXD 696 - Black BGXD 697 - Grey BGXD 698 - Navy Blue

XDDESIGN® For university, school, work or your next trip, the Bobby Soft Backpack is ready! The iconic Bobby anti-theft design with hidden RFID protected pockets, no front access and hidden zippers is now complemented with a safe zipper puller on the main compartment. In the main compartment, you can easily organise your gear with a padded 15.6" laptop compartment, notebook pocket, smart pockets and a keychain clip. The top of the backpack is expandable giving additional space. This backpack is also equipped with an integrated USB charging port and water repellent material. Made from R-pet materials and AWARE™ tracer. With AWARE™, the use of genuine recycled fabric materials and water reduction is guaranteed, by using the AWARE disruptive physical tracer and blockchain technology. Each Bobby Soft saves 23L of water and reuses 39 plastic bottles. Registered design®

Print Technique : SC

Preferred Print Location : Front

Max Print Size : 200 X 150 mm

Product size : 30 x 18 x 45 cm

# REDUCING THE USE OF WATER

BY USING TRACEABLE AND CERTIFIED RECYCLED MATERIALS WE  
SAVE HUGE AMOUNTS OF WATER

## EACH XD DESIGN SUSTAINABLE BACKPACK:

### REUSE

AN AVERAGE OF

# 31

### WATER BOTTLES



### SAVED

AN AVERAGE OF

# 18



### LITRES OF WATER

Bobby + Recycled PET  
= **BOBBY HERO**  
Anti - Theft Backpack  
(The ORIGINAL just got better)





Red



Black



Green



Grey



Navy Blue

Made from (rPET)  
Recycled PET Bottles

Scan Below QR  
code to watch  
product video



Light Blue

- > Each bag is made of 27 plastic bottles
- > Each bag saves 16 liters of water
- > Made with AWARE™ tracer

READY STOCK



BOBBY HERO

BGXD 625 - Black    BGXD 626 - Grey    BGXD 627 - Navy Blue    BGXD 628 - Red    BGXD 629 - Green    BGXD 630 - Light Blue

XDDESIGN® The Bobby Hero line is our new generation of anti-theft backpacks. This new model will help you to move safely, carefree and organised. Key features such as cut-proof protection, hidden zipper closures & pockets will keep your belongings safe during your commutes. Bobby is also the most convenient backpack with features such as an integrated USB charging port, water-repellent fabric, illuminating safety strips and a luggage strap. On the inside there are padded compartments for a 15.6" laptop, tablet up to 12.9" and all your other belongings. Made from R-pet materials and AWARE™ tracer. With AWARE™, the use of genuine recycled fabric materials and water reduction impact claims are guaranteed, by using the AWARE disruptive physical tracer and blockchain technology. Each Bobby Hero regular saves 16 litres of water and reuses 27 plastic bottles. Registered design®

Print Technique : SC

Preferred Print Location : Front

Max Print Size : 150 X 150 mm

Product size : 45 x 16 x 29 cm

Packing Details : 69 x 60 x 49 cm ; 6 pcs /carton ; gw/nw: 10.9 kg/ carton



# THE BOBBY SLING BAG



Made from genuine recycled fabric  
All IMPACT claims verified using AWARE disruptive physical tracer & Blockchain technology

**IMPACT**

For each product sold we have donated 2% of proceeds to support Water.org to change lives with safe water.

**THIS BAG IS MADE OF 20 RECYCLED WATER BOTTLES**



**THIS BAG SAVED 12L WATER**

785 million people — 1 in 9 — lack access to safe water

We are supporting Water.org to change this. [www.theimpactcollection.org](http://www.theimpactcollection.org)



Xindao B.V.  
The Netherlands

For more info visit: [www.theimpactcollection.org](http://www.theimpactcollection.org)

READY STOCK





Scan Below QR code to watch product video



Made from (rPET)  
Recycled PET Bottles

-  
12L



READY STOCK



BGXD 691 - BOBBY SLING

**XDDESIGN®** Safe, comfortable and smart, the Bobby Sling was designed for the city travellers. Feel protected with the famous Bobby anti-theft features like hidden zippers, no front access, RFID protected pocket and cut resistant material, also a 3 point safe buckle will make sure that your daily essentials are always along your body. Additional features like water-resistant material and integrated USB charging port makes this crossbody backpack the most convenient option for your everyday journey. Made from R-pet materials and AWARE™ tracer. With AWARE™, the use of genuine recycled fabric materials and water reduction impact claims are guaranteed, by using the AWARE disruptive physical tracer and blockchain technology. Each Bobby Sling saves 12 litres of water and reuses 20 plastic bottles. Registered design®

Print Technique: SC Preferred Print Location : Front Max Print Size : 120 X 120 mm  
Product size : 32.5 x 9 x 21 cm Packing Details : 38 x 51 x 53.5 cm ; 8 pcs /carton ; gw/nw: 7.5 kg/ carton



# BOBBY TECH SOLAR BACKPACK

- > Solar Powerbank Backpack
- > Integrated Wireless Charger
- > Patented Fid Lock System
- > Anti-Theft Backpack Series - Regd. Design



READY STOCK



**BGXD 621**

XDDDESIGN® Bobby Tech is the ultimate backpack for gadget lovers; combining safety, comfort and the latest technology into great features. The integrated solar panel will ensure that you can charge your devices directly from solar power and never run out of power. An integrated wireless charging module makes sure you can charge your mobile device without the hassle of any cables. Bobby Tech has adjustable internal dividers which allow you to divide your backpack in many different ways. The patented fid lock system on the shoulder strap gives you quick and easy access to your phone or bottle/coffee cup. And of course the original Bobby features as hidden zippers, RFID protected pockets and cut proof PP board protection are still there. Registered design®

Print Technique : SC, HT  
 Product size : 41 X 27.3 X 16.5 cm

Preferred Print Location : Side  
 Packing Details : 68 x 44 x 47 cm ; 6 pcs /carton ; gw/nw: 7.5/8.5 kg / carton

Max Print Size : 80 x 90 mm





READY STOCK



- > Made from GRS Certified RPET
- > Modern minimalist design

BARUTH

**BPGL 674** - Black **BPGL 675** - Grey **BPGL 676** - Blue

Baruth Office Laptop Backpack is made with GRS-certified RPET. Many useful features include external USB for smart charging, side pocket, front pocket for quick access and trolley harness.

Print Technique : SC, HT  
Product size : 42 X 31 X 16 cm

Preferred Print Location : Front  
Packing Details : 46 x 35 x 47 cm ; 10 pcs /carton ; gw/nw: 12/13 kg / carton

Max Print Size : 200 x 150 mm



### DO YOU KNOW THE WATER FOOTPRINT OF COTTON?

It takes **20,000 Liters of water** to produce 1kg of cotton fiber.

Source: WWF

Continue reading



READY STOCK

300 GSM Sturdy Fabric

This Bag Saved

**-4,000 Litres**

Water



**CTEN 425 - BORKUM**

Eco neutral GRS-Certified Recycled Cotton Beach Bag in Natural color - Least / almost NIL Impact on environment

Print Technique : SC

Max Print Size : 330 x 420 mm

Preferred Print Location : Front

Product Size : 40 x 47 x 17 cm



300 GSM Sturdy Fabric

This Bag Saved

**-10,000 Litres**

Water



**DBEN 430 - PUEBLA**

Eco neutral GRS-Certified Recycled Cotton Duffel Bag in Natural color - Least / almost NIL Impact on environment

Print Technique : SC

Max Print Size : 180 x 160 mm

Preferred Print Location : Front Pocket

Product Size : 49 x ø26 cm

- > Outside Zipper pocket for quick access & safety
- > Easy to wash-&-clean



~~1,200 - 5,000~~  
Litres of water  
needed to  
make 1 normal  
Cotton Bag

Move to →

0.02 - 0.05  
Litres of water  
needed to  
make an eco neutral  
Recycled Cotton Bag

Please choose responsibly!



Natural

This Bag Saved

**-1,200**  
Litres

Water

140 GSM  
Light & Durable



Black



Ink Blue



Blue



ABLAR

CTEN 420 - Ink Blue CTEN 421 - Natural CTEN 422 - Black CTEN 423 - Blue

Eco neutral GRS-Certified Recycled Cotton Tote bag 140 gsm

Print Technique : SC

Preferred Print Location : Front

Max Print Size : 350 x 320 mm

Product Size : 42 x 36 cm



Natural



Black

READY STOCK

This Bag Saved

**-4,000**  
Litres

Water

300 GSM  
Sturdy Fabric



DARGUN

CTEN 427 - Natural CTEN 428 - Black

Eco neutral GRS-Certified Recycled Cotton Tote Bag with Bottom Gusset 300 GSM

Print Technique : SC

Preferred Print Location : Front

Max Print Size : 300 x 320 mm

Product Size : 42 x 38 x 10 cm



# COTTON BAGS & POUCHES



Black

Navy Blue



White

Natural



**CT 001 - STRUM**

Print T : SC, HT      Print L : Front & Back  
Max Print Size : 320 x 340 mm      Product Size : 42 x 38cm  
Packing Details : 46 x 46 x 48 cm;  
250 pcs/carton; gw/nw: 19.50 kg/carton



White



Natural



**CT 101 - TSIO**

Print T : SC, HT      Print L : Front & Back  
Max Print Size : 260 x 300 mm      Product Size : 38 x 32 x 12cm  
Packing Details : 46 x 46 x 48 cm;  
150 pcs/carton; gw/nw: 20 kg/carton

## eco-neutral



Dulux



**CT 501 - CAPTRU**

**eco-neutral** Cotton wallet with Foldable shopping bag  
Print T : SC, HT      Print L : Pouch & Bag  
Max Print Size : (Bag) 270 x 290 mm  
(Pouch) 80 x 50 mm  
Product Size : 12 x 11 x 3.5 cm (Pouch) 32 x 33 (Bag)  
Packing Details : 46 x 46 x 48 cm;  
225 pcs/carton; gw/nw: 18.375 kg/carton

READY STOCK



**BPMK 130 - BREA**

Bag made from 100% cotton material and in combination of body of natural color and handles in a varied range of bright tones. With 70cm long handles and stitched finishing. Takes up to 7kg of weight. 105 gsm.  
Print Technique : SC, HT      Preferred Print Location : Front  
Max Print Size : 330 x 350 mm      Product Size : 37 x 41 cm  
Packing Details : 45 x 40 x 30 cm;  
250pcs / carton ; gw / nw : 12 kg / carton



**CT 301 - SUSINOC**

Cotton Toiletry Pouch  
Print T : SC, HT      Print L : Front  
Max Print Size : 190 x 70 mm  
Product Size : 23 x 13 x 5cm  
Packing Details : 56 x 56 x 38 cm;  
100 pcs/carton gw/nw: 20.8 kg/carton

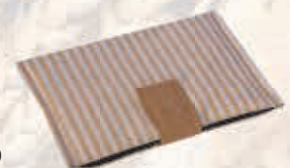

**CT 601 - TRUIO**

Cotton Tablet Case  
Print T : SC  
Print L : Front  
Max Print Size : 230 x 110 mm  
Product Size : 29 x 22 x 5 cm



eco friendly / cost effective / all purpose bags



White



Natural



JT 101 - SISMAC

Print Technique : SC, HT Preferred Print Location : Front & Back  
Max Print Size : 250 x 300 mm Product Size : 38 x 30 x 12 cm  
Packing Details : 56 x 56 x 38 cm ; 100 pcs /carton ; gw/nw: 21.40 kg / carton



Natural

➤ Front Pocket for convenience;  
Option of 3 colors



Black



Blue



MONCLOVA

JTEN 432 - Natural JTEN 433 - Black JTEN 434 - Blue

Jute Bag with Front Pocket  
Print Technique : SC, HT Preferred Print Location : Front & Back  
Max Print Size : 380 x 230 mm Product Size : 44,5 x 35,5 x 11,5 cm

READY STOCK



Natural



➤ Front & Back Canvas ensures clear printing



White



JT 201 - KRISKIT

Print Technique : SC, HT Preferred Print Location : Front & Back  
Max Print Size : 380 x 270 mm Product Size : 33 x 43 x 15 cm  
Packing Details : 56 x 56 x 38 cm ; 80 pcs /carton ; gw/nw: 20.4 kg / carton



JTEN 2104 - FRUNZA

eco-neutral Jute/Cotton Bag  
Print Technique : SC Preferred Print Location : Front & Back  
Max Print Size : 350 X 240 mm Product Size : 42.5 x 34 x 14.5 cm



# REUSABLE NON-MEDICAL FACE MASK

## 50X

REUSABLE & MACHINE  
WASHABLE WITH  
GUARANTEE OVER 99%  
ANTIBACTERIAL RATE

## 100%

ECO-FRIENDLY COTTON

## > 95%

BACTERIAL FILTRATION  
EFFICIENCY (BFE)  
FOR PARTICLES > 3 MICRO  
METER



ADJUSTABLE  
EARLOOPS  
ONE SIZE FITS ALL

Eco  
Friendly  
Cotton

MCMS 105 - REPS

SANTHOME PROTECT Reusable Non-Medical 2 layer cotton face mask that is treated with Silvadur TM (A DuPont product) antibacterial agent. Comfortable daily use masks that protect you and do not harm the environment!

Print Technique : SC , HT

Preferred Print Location : Right Side

Max Print Size : 60 X 40 mm

Packing Details : 57 x 40 x 20 cm ; 600 pcs / carton ; gw / nw : 9.20 kg / carton

### eco friendly / cost effective / all purpose bags

READY STOCK

#### eco-neutral

Natural



CT 401 - ZITUTE

eco-neutral Cotton Draw String Bags

Print Technique : SC, HT

Preferred Print Location : Front & Back

Max Print Size : 330 x 300mm

Product Size : 34 x 42cm

Packing Details : 46 x 46 x 48cm; 200 pcs/carton;

gw/nw: 20.90 kg/carton



White / green



RPET 001 - ANOKIS

Recycled RPET Bag

Print Technique : SC PPL : Front & Back

Max Print Size : 260 x 300 mm

Product Size : 38 x 30 x 12 cm

Packing Details : 34 x 42 x 40 cm; 100 pcs/carton;

gw/nw: 8 kg/carton



White



BPMK 127 - BRAWLEY

Bag made from 100% organic cotton material with natural color finish. With reinforced short handles of 35cm in green color, gussets and stitched finishing. Takes up to 9kg weight. 145gsm.

Print Technique : SC, HT Preferred Print Location : Front

Max Print Size : 360 x 340 mm

Product Size: 40 x 40 x 10 cm

Packing Details: 38 x 44 x 54 cm; 200 pcs / carton;

gw / nw: 17 kg / carton



NGINX



*Eco friendly / cost effective / ideal for exhibitions*



Black

Royal Blue

White

Navy Blue

Cream

Red

**NW 001 V - NONWOA SOLID**

Print Technique : SC, HT

Preferred Print Location : Front & Back

Max Print Size : 260 x 300 mm

Product Size : 38 x 30 x 10 cm

Packing Details : 68 x 42 x 37.5 cm; 250 pcs/carton; gw/nw: 11.3 kg/carton



White/R.Blue

White/Grey

White/Black

White/Green



White/Navy

White/Orange

White/Red

White/Maroon

**NW 001 V - NONWOA EDGE**

Print Technique : SC, HT

Preferred Print Location : Front & Back

Max Print Size : 260 x 300 mm

Product Size : 38 x 30 x 10 cm

Packing Details : 68 x 42 x 37.5 cm; 250 pcs/carton; gw/nw: 11.3 kg/carton



White



Black

**NW 001 H - LUKAOK**

Print Technique : SC, HT

Preferred Print Location : Front & Back

Max Print Size : 390 x 250 mm

Product Size : 33 x 43 x 12 cm

Packing Details : 74 x 47 x 37.5 cm; 250 pcs/carton; gw/nw: 14 kg/carton



READY STOCK



# ECO FRIENDLY MISCELLANEOUS GIFTS



eco-neutral



## CUTLERY SET



HELEN 197 - HELLA

**eco-neutral** A compact and convenient alternative to single-use plastic cutlery. Make a natural choice with our Wheat Straw Cutlery Set consisting of a knife, spoon and fork packed in a convenient wheat straw box.

Print Technique : UV, SC  
Product Size : 20.3 x 5.5 x 2.2 cm

Preferred Print Location : Case  
Packing Details : 32 X 24 X 49 cm ; 100pcs /carton ;

Max Print Size : 190 X 50 mm  
gw/nw: 7.4 / 7.8 kg / carton

READY STOCK



Made from Beech Wood



- 01 Large nose pliers
- 02 Standard pliers
- 03 Wire cutter
- 04 Serrated blade
- 05 Knife
- 06 Phillips screwdriver
- 07 Bottle opener
- 08 Flat screwdriver
- 09 Small flat screwdriver
- 10 Can opener
- 11 Saw
- 12 File
- 13 Large screwdriver

MTXD 101 - WOOD MULTITOOL

**XD COLLECTION** Strong and durable multitool with 13 functions. With beech wood case and high quality stainless steel tools. Tools include: Long nose plier, standard plier, wire cutters, serrated blade, bottle opener, large flat screwdriver, phillips screwdriver, knife, saw, small flat screwdriver, can opener, medium flat screwdriver, file. Packed in gift box.

Print Technique : SC,UV, ENG  
Product Size : 2.1 X 4.6 X 9.8 cm

Preferred Print Location : Front  
Packing Details : 40 X 19 x 29.50 cm ; 40 pcs /carton ;

Max Print Size : 40 x 10 mm  
gw/nw: 11.5 kg / carton





- ▶ 183 x 61 cm Size , 0.5 cm Thick
- ▶ Cork is a renewable material
- ▶ Stay fit, Stay healthy
- ▶ Employees (HR) gift



**WZEN 166** - ARCALIS

Cork Yoga mat - high end feel. TPE used in base material.

Print Technique : SC,HT

Preferred Print Location : Pouch

Max Print Size: 200 X 50 mm

Product Size : 183 X 61 X 0.5 cm

Packing Details : 47 X 35 X 63.5 cm ; 12 pcs / carton ; gw / nw : 10.8/11.8 kgs / carton

READY STOCK

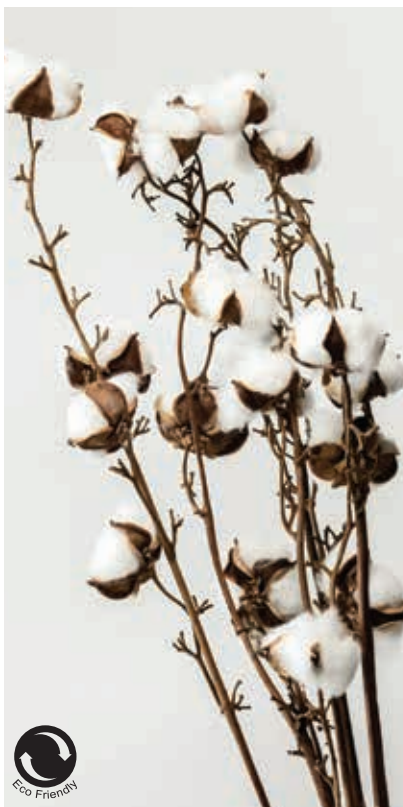

**XANTHI**

**WZEN 165** - JUMPING ROPE (Skipping)

A cotton Jumping Rope with wooden Handle, in cotton pouch

Print Technique : SC

Preferred Print Location : Pouch

Max Print Size: 110 X 150 mm





## KIDS STATIONERY GIFTS & SUNGLASSES (ECO)



PRILEP

SGEN 101 - Blue SGEN 102 - Green

**eco-neutral** Sunglasses with frame made out of wheat straw fibre. Packed in kraft paper box. With UV 400 glasses.

Print Technique : SC

Preferred Print Location : Side

Max Print Size : 50 x 5mm

Product Box Size : 3 X 5.5 X 14.5 cm

Packing Details : 65 X 29.5 X 41 cm ; 200 pcs / carton ; gw / nw : 10 kg / carton

READY STOCK

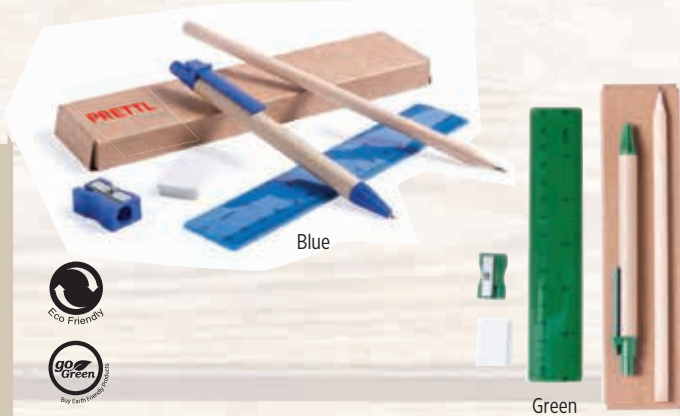

Blue

Green

BATAK

STMK 101 - Blue STMK 141 - Red STMK 142 - Green

Set of 5 pieces presented in natural cardboard box. Includes push-up mechanism ball pen and blue ink in recycled cardboard, wooden cylindrical body pencil, pencil sharpener, rubber and 15 cm ruler.

Print Technique : UV, SC

Preferred Print Location : Box

Max Print Size: 100 X 30 mm

Product Size : 4.5 X 17.7 X 1.5 cm

Packing Details : 38 X 34 X 48 cm ; 400 pcs / carton ; gw / nw : 14 kg / carton



STMK 103 - KAMENO

Set of 5 pieces. Includes 2 black mine pencils with cylindrical body, eraser and pencil sharpener. Presented in a ruler box with

Print Technique : UV, SC

Preferred Print Location : Rectangular Part

Max Print Size: 15 X 32 mm

Product Size : 15.5 X 4 X 1.3 cm

Packing Details : 53 X 24.5 X 35 cm ; 500 pcs / carton ; gw / nw : 15 kg / carton



STMK 139 - BATU

Box of 4 wooden pencils with hexagonal body and in natural finish. Presented in natural cardboard box with window.

Print Technique : SC, UV

Preferred Print Location : Front Cover

Max Print Size : 40 x 20 mm

Product Size : 3 x 9 x 0.8 cm

Packing Details : 27 x 23.5 x 47.5 cm ; 1000pcs / carton ; gw / nw : 12kg / carton



GMMK 103 - BYALA

Classic skill game mikado with 41 wooden sticks. Presented in wooden box with sliding cover.

Print Technique : ENG, SC

Preferred Print Location : On the side

Max Print Size: 100 X 20 mm

Product Size : 19.3 X 2.5 X 4.1 cm

Packing Details : 47 X 21 X 28 cm ; 100 pcs / carton ; gw / nw : 10 kg / carton



eco-neutral



Dark Grey Exterior

Light Grey Exterior



CH 139 - TRAILL

eco-neutral Pocket Cards Holder in attractive color combinations with eco-friendly felt jacket

Print Technique : SC Preferred Print Location : Center  
 Max Print Size : 50 x 90 mm Product Size : 8.5 x 11 x 1 cm  
 Packing Details : 54.5 x 27 x 30.5 cm; 200 pcs/carton; gw/nw : 7 kg/carton



- > Convenient eco-friendly device holder
- > Smooth, lacquered bamboo finish



ITGL 1124 - SINTRA

Giftology Bamboo Mobile Holder

Print Technique : UV, SC, EN Preferred Print Location : Top  
 Max Print Size : 48 x 40 mm Product Size : 8 x 6 x 2 cm



BEECH WOOD

KCMK 102 - MARFA

Smart nature line keychain. Obtained from cuts of beech wood, being all of them different and unique, each one with its own texture, thickness and color. With a wide printing area.

Print Technique : SC, ENG, UV  
 Preferred Print Location : Front/Back  
 Max Print Size : 40 x 24 mm Product Size : Variable  
 Packing Details : 40 x 36 x 40 cm  
 ; 800 pcs / carton ; gw / nw : 13 kg / carton



ITGL 1125 - VARDO

Giftology Bamboo Phone Grip and Stand with adjustable height

Print Technique : UV, SC, ENG Preferred Print Location : Top  
 Max Print Size : ø36 mm Product Size : 0.8 x ø4 cm

READY STOCK



DTLC 801 - LUBLIN  
 Square Wooden Coaster



DTLC 804 - PLOCK  
 Round Cork Coaster



DTLC 803 - MALBORK  
 Round Wooden Coaster



DTLC 802 - RADOM  
 Square Cork Coaster



- > Pen
- > Spirit Level
- > Ruler (7 cm)
- > Screw Driver
- > Stylus Tip
- > Solid Bamboo



WIEN 876 - WILTZ

eco-neutral Multifunction bamboo pen with ruler (7cm) , spirit level, screw driver, stylus tip and ballpoint. Made from bamboo with aluminium clip. German Documental Ink (Blue)

Print Technique : UV, SC, ENG Preferred Print Location : Barrel Max Print Size : 25 X 10 mm  
Product Box Size : 2.3 x 5.3 x 17 cm Packing Details : 27 x 31 X 37 cm ; 100 pcs / carton ; gw / nw : 15.5 kg / carton

READY STOCK



WIEN 877 - ETERNITY

eco-neutral Bamboo eternity pencil replaces your traditional wooden pencil. Traditional wooden pencils write only up to around 200 metres, but this bamboo eternity pencil, has a writing length of up to around 20,000 metres using a graphite tip to produce a graphite line. Not only does it write like a pencil, but the markings can be erased. It works by leaving a graphite line on paper just like a regular traditional wooden pencil but it wears down so slowly, that it should outlast up to 100 traditional wooden pencils!

Print Technique : UV, SC, ENG Preferred Print Location : Front Max Print Size : 100 X 4 mm  
Product Size : 14.5 x ø1 cm



- > Bamboo eternity pencil writes upto 20,000 metres
- > Replaces 100 traditional wooden pencils
- > No sharpening needed



Natural Blue Green

Wheat Straw Trims

Bamboo Body



SERANG

WIEN 101 - Natural WIEN 102 - Blue WIEN 103 - Green

eco-neutral Eco-Friendly push-up mechanism ball pen. Body in bamboo, with accessories in wheat straw, to encourage the use of natural raw materials.

Print Technique : UV, SC, ENG Preferred Print Location : Barrel Max Print Size : 6 x 50 mm  
Product Size : 14 x ø1 cm Product Size : 15 x ø1 cm Product Size : 16 x ø1 cm  
Packing Details : 48 x 31 x 22 cm ; 1000 pcs /carton ; gw/nw: 9.5 kg /carton





Black



Brown

Eco Recycled Leather adds elegance

KORU

WIEN 5110 - Black WIEN 5111 - Brown

eco-neutral Chrome metal pen with recycled leather barrel. Packed in a vintage recycled leather tube gift box. Blue ink

(Pen) Print Technique : UV, SC, ENG

Preferred Print Location : Next to Clip

Max Print Size : 40 x 8 mm

(On Leather Packaging) Print Technique : SC

Preferred Print Location : On Leather Packaging

Max Print Size : 150 x 15 mm

Product Size : 14 x 1.6 cm

READY STOCK



WIEN 5109 - ATCA

eco-neutral Elegant bamboo & chrome metal pen with clip. Packed in a matching metal / bamboo gift box.

Print Technique : UV, SC, ENG

Preferred Print Location : On Tube

Max Print Size : (On Tube) 100 X 4 mm; (On Pen Barrel) 40 X 3 mm

Product Size : 16.4 x ø2.5 cm (incl tube)



# ECO-FRIENDLY/ ANTI-BACTERIAL NOTEBOOKS & FOLDERS

## SANTHOME PROTECT

- Cover made from recycled plastic (rPET) & treated with silver-ion Anti-Bacterial Technology
- FSC Certified Paper
- A5 Ruled Notebook, 160 Pages



Black  
Navy Blue  
Grey

### BOOKMARK



**This Notebook Cares for You**  
Functional & Safe notebook that protects you against harmful microbes that may adhere to its surface. Kills 99.9% bacteria using Silver-Ion Technology.

**This Notebook Loves Trees**  
Paper used to make this notebook is FSC certified. FSC® certified paper is paper that has been harvested in a socially and environmentally responsible manner. By using a FSC certified paper, you are helping to ensure our forests are alive for generations to come.

**This Notebook Cares for the Environment**  
The fabric cover of the notebook is made using recycled post-consumer plastic. The rPET material itself is sourced from a Global Recycled Standard (GRS) certified factory. GRS certifies and communicates truth in materials and support for a circular economy that reduces waste by using it to make new products.

**A notebook that is proudly made and a notebook you would proudly use!**



ORSHA

NBSN 341 - Black    NBSN 342 - Grey    NBSN 343 - Navy Blue

**SANTHOME PROTECT** A notebook that cares for you and for the environment. The cover of the notebook is made from recycled plastic (rPET) in a GRS Certified factory that complies with global recycling standards and is treated with anti-bacterial technology to provide protection against the growth of harmful bacteria. The paper used in this notebook is acid-free and FSC Certified. A5 notebook with 160 ruled pages each of 70 gsm

Print Technique : SC, HT

Preferred Print Location : Front

Max Print Size : 120 X 200 mm

Product Size : 14 X 21 X 1.4 cm

Packing Details : ( Black ) 36.5 X 33 X 24 cm ; (Black = 50 pcs) / carton ; (Grey& navy Blue = 59 pcs / carton gw / nw : 13.3 kg / carton

READY STOCK



Black

Red



A4

FO 3341 - SORBUS

A4 folder with a button closure made from Eco-friendly material. Consists of a notepad with 70 pages, matching coloured pen and a pocket to keep documents and business cards.

Print Technique: SC Preferred Print Location: Center

Max Print Size : 300 x 140 mm Product Size : 22.5 x 31.5 x 2 cm

Packing Details : 51 x 35 x 34.5 cm; 30 pcs/carton; gw/nw: 17kg/carton



A4

Blue Exterior

Craft Exterior



FO 3340 - JUDAS

A4 folder with a button closure made from Eco-friendly material. Consists of a notepad with 40 pages, pen loop and pocket to keep documents and business cards.

Print Technique : SC

Preferred Print Location: Top Right

Max Print Size : 130 x 100 mm Product Size : 23.5 x 32.5 x 1.5 cm

Packing Details : 52 x 38.5 x 35 cm; 40 pcs/carton; gw/nw: 14.5 kg/carton



Black



Blue



Red



Green



BORSA

NBEN 103 - White NBEN 501 - Black NBEN 502 - Blue NBEN 503 - Red NBEN 504 - Green

**eco-neutral** Borsa is an eco friendly notebook with 160 pages each 80 gsm and made from a combination of fabric and cork materials. Also includes a matching Eco Friendly pen made from Cork and Eco-Friendly Wheat Straw. Packed in an eco gift box.

Print Technique : UV,SC Preferred Print Location : Front Bottom Max Print Size : 60 x 110 mm (Book) 40 x 7mm (Pen clip)  
Box Size : 22 x 16 x 1.8 cm Packing Details : 50.8 x 35 x 25.8cm; 48 pcs/carton; gw/nw: 15.5 kg/carton

READY STOCK



- > 80 Pages Ruled Notebook
- > Eco-Friendly Cover
- > A5 Size
- > Value Deal !!

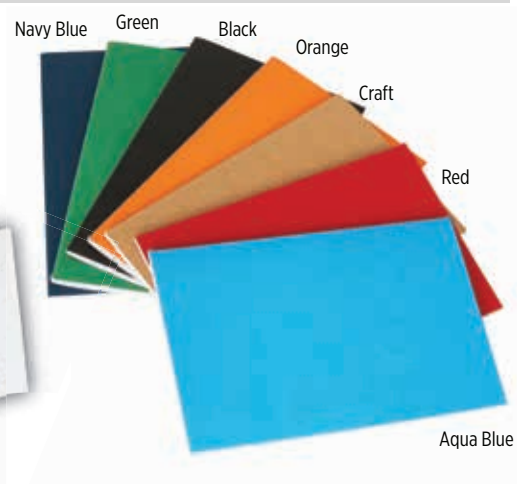

VINICA

NBGL 215-Black NBGL 216-Craft NBGL 217-Aqua Blue NBGL 218-Navy Blue NBGL 219-Red  
NBGL 220-Green NBGL 221-Orange

**eco-neutral** Classic design notebook with cardboard covers in eye-catching colors and smooth finish. With matching color seams on side and 80 ruled pages.  
Print Technique : SC, UV Preferred Print Location : Front Max Print Size : 100 x 170 mm  
Product Size: 20.5 x 14 x 0.5 cm



READY STOCK

**IMPACT**

For each product sold we have donated 2% of proceeds to support Water.org to change lives with safe water.

**THIS PORTFOLIO IS MADE OF 7 RECYCLED WATER BOTTLES**



**THIS PORTFOLIO NOTEBOOK SAVED 4L WATER**

785 million people — 1 in 9 — lack access to safe water  
We are supporting Water.org to change this.



Xindao B.V.  
The Netherlands

For more info visit: [www.theimpactcollection.org](http://www.theimpactcollection.org)



Features -



Confirms to the Cadmium Directive 91 | 338 | EC



U.S. Lead content compliance



Free from single & multichain chlorinated paraffins

NBAW 454 - Black NBAW 455 - Anthracite NBAW 456 - Navy Blue

XD COLLECTION No greenwashing, but telling a true story about sustainability! This Impact collection is made with AWARE™ tracer. With AWARE™, the use of genuine recycled fabric materials and water reduction impact claims are guaranteed, by using the AWARE disruptive physical tracer and blockchain technology. Save water and use genuine recycled fabrics. If you choose this item you save 4 litres of water and 7 plastic bottles have been reused. With the focus on water, 2% of proceeds of each Impact product sold is donated to Water.org. Keep all your work essentials organised with the A5 AWARE™ RPET portfolio. Inside the portfolio you can find a matching notebook. The notebook contains 64 sheets/128 sheets cream coloured lined 80gm/s FSC recycled paper. Inside you will find 1 big sleeve pocket, a phone pocket, 2 card slots and pen loop. Interior and exterior 100% recycled polyester with AWARE™ tracer. PVC free.

Print Technique : SC Preferred Print Location : Front Max Print Size : 100 x 80 mm Product Size : 2.1 x 17.2 x 22.2 cm Packing Details : 26.5 X 37.5 X 39.5 cms ; 20 pcs / carton ; gw / nw : 11 kg / carton





Grey



Black

READY STOCK

- > Made with GRS-certified recycled PET (rPET)
- > Smart 2-in-1 Laptop Holder / Desk Organizer

- > Magnetised laptop stand raises laptops by 7cms
- > 4 smart pockets for your phone and all required accessories



Laptop Organizer



Desk Stand & Organizer

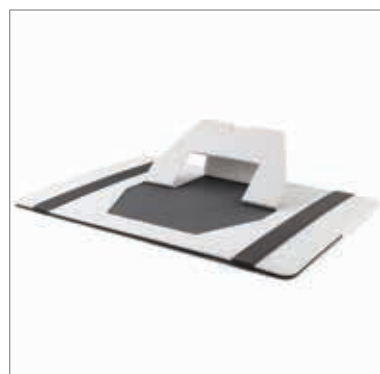

Ergonomic Laptop Stand

ZABKI

LSGL 413 - Black LSGL 414 - Grey

Giftology ZABKI - A stylish, sustainable and functional desk organiser & laptop holder with magnetised stand, ideal for easy work with laptops anywhere. Made of GRS-certified recycled polyester (rPET). Including ball pen loop and smartphone pocket, with 4 additional elastic pockets for storage of multiple gadgets.

Print Technique : SC Preferred Print Location : Front Right Side of Pen loop Max Print Size : 115 X 55 mm

Product Size : 30.5 x 22cm



Die Handschrift der Werbung

A Climate-Neutral Pens Factory in Germany

All **UMA** Pens are 100% Carbon Neutral



Supported offset project  
**Carbon offset + Regional nature conservation**  
**1t CO2 + Financial contribution**  
**International + Freiburg**



**2,636,777 kg CO<sub>2</sub>**  
have been offset



[ClimatePartner.com/13223-1907-1003](https://ClimatePartner.com/13223-1907-1003)

### Climate-neutral company

To ensure sustainable development, an important aspect for us is to take a holistic view of the three components: economics, environment and society. In collaboration with Climate Partner, our factory in Fischerbach, Germany is 100% climate-neutral – this includes the processing of all uma pens. The unavoidable emissions are compensated through climate protection projects. We consciously focus on investing in our region. The forest protection project in Freiburg aims to protect our valuable rural environment.

Facts:

- Emissions of 2,636,777 kg CO<sub>2</sub> compensated to date
- 100% climate-neutral processing in Fischerbach
- 25 UMA product collections manufactured, processed and delivered climate-neutrally



- Executive Uma set with unique mesh barrel
- German-made Uma refills that lasts upto 10,000 meters of flawless writing
- Packed in an elegant gift box with sleeve

**WIGS 5122 - BLACK FOREST**

Black Forest is a premium gift set of 2 award-winning mesh design metal pens from Uma - made in Germany. The set contains a rollerball and a ballpoint pen with glossy lacquered finish and an integrated mesh band on the barrel. The set also contains an added German-made Dokumental ink refill for each pen. Packed in a premium magnetic gift box with sleeve.

Print Technique : SC      Print Location : On Gift Box      Max Print Size : 219 x 150 mm  
Product Size : 22 x 15 x 2.7 cm



➤ Luxurious Stone look Pens



Dark Grey      Light Grey

**LUMOS STONE**

**WIMP 444** - Light Grey    **WIMP 445** - Dark Grey

Retractable metal ballpoint pen with reconstructed concrete or stone look and touch. Metal clip and push button matt chromed. From UMA- a Climate-Neutral Certified factory in Germany.

Print Technique : UV, SC      Print Location : Next to Clip      Max Print Size : 3 x 30 mm

**READY STOCK**



Black Grey Dark Blue Light Blue Red Dark Green Light Green Purple



Climate neutral certified  
Elegant Soft-touch  
Engraving reveals beautiful lacquered metal underneath

READY STOCK

LUMOS GUM

WIMP 5112 - Black WIMP 5113 - Grey WIMP 5114 - Dark Blue WIMP 5115 - Light Blue WIMP 5116 - Red WIMP 5117 - Dark Green  
WIMP 5118 - Light Green WIMP 5119 - Purple

Lumos GUM by Uma is a metal retractable ballpoint pen with soft touch housing. Metal clip and push-button matt chromed. Manufactured in The Black Forest, Germany, all Uma pens are climate-neutral certified

Print Technique : UV, SC, ENG

Print Location : Next to Clip

Max Print Size : 3 x 30 mm

Grey Red Black Sky Blue Navy Blue



MP 921 - STRAIGHT

UMA Metal Pens from germany

Print Technique : UV, SC, ENG

Max Print Size : 30 x 5.5 mm

Box Size : 3 X 16.2 X 1.2 cm

gw/nw: 18.5 kg/carton

Print Location : Next to Clip

Product Size : 14 X ø1.2 cm

Packing Details : 39 X 24 X 30cm; 1000 pcs/carton;

Packing: PB 1053

White Black Black White



PP 291 - KYOM

UMA Retractable ballpoint pen with metal clip & pusher in silver matt

Print T. UV, SC Print L. Barrel

Max Print Size : 40 x 5.5 mm

Product Size : 14 x ø1.2 cm

PP 244 - CHILL

UMA Twist ballpoint pen with shiny solid colored body, heavy, matt chrome metal tip and metal clip

Print T. UV, SC Print L. Barrel

Max Print Size : 40 x 6 mm

Product Size : 14.5 x ø1.3 cm



**PP 251 - ULTIMATE**

Print Technique : UV, SC    Print Location : Barrel  
Max Print Size : 40 x 6 mm    Product Size : 14.4 x ø1.2 cm  
Packing Details : 39 X 29 X 24 cm ; 1000 pcs / carton ; gw / nw : 14.5 kg / carton



**PP 242 - STRIPE**

Print T. UV, SC  
Print L. : Barrel  
M. Print Size : 40 x 6 mm  
Product Size : 14.5 x ø1.3 cm  
Packing Details: 39 X 29 X 34 cm ; 1000 pcs / carton ; gw / nw : 11 kg / carton



**PP 240 - SPEED**

Print T. UV, SC  
Print L. : Barrel  
Max Print Size: 40 x 4 mm  
Product Size: 15 x ø1.3 cm



**PP 243 - FANTASY**

Print T. UV, SC  
Print L. Barrel  
M. Print Size : 40 x 4 mm  
Product Size : 14.5 x ø1.3 cm



**PP 243 - FLAG**

Print T. UV, SC  
Print L. Barrel  
M. Print Size : 40 x 4 mm  
Product Size : 14.5 x ø1.3 cm

**READY STOCK**



Red    Royal Blue    Green    Grey    Black    Purple    Aqua Blue    Orange    White

**HAPPY**

WIPP 601 - Black    WIPP 602 - White    WIPP 603 - Grey    WIPP 604 - Royal Blue  
WIPP 605 - Aqua Blue    WIPP 606 -Red    WIPP 607 - Green    WIPP 608 -Purple    WIPP 609 - Orange

UMA Ballpoint pen with tungsten carbide ball (1mm) & 2200 linear meter writing length.

Print Technique : UV, SC    Preferred Print Location : Clip    Max Print Size : 35 X 7 mm  
Product Size : 13.8 x ø1 cm



**PP 235 - PENNY FROZEN**

UMA Retractable ballpoint pen with white barrel and colored frosted clip  
Print T. UV, SC    Print L. : Barrel  
Max Print Size : 40 x 6 mm  
Product Size : 14.5 x ø1.3 cm  
Packing Details: 40 X 28 X 39 cm ; 2000 pcs / carton ; gw / nw : 20.5 kg / carton

\* Look for the **UMA** brand on the pen



# WIRELESS CHARGER NOTEBOOK WITH PHONE STAND

# SANTHOME



READY STOCK



### NBSN 5126 - KAMEZ

SANTHOME Wireless Charger (15W fast charging) A5 Notebook Organizer with in-built folding mini workstation - truly an avant-garde modern office notebook. Includes an integrated business cardholder, magnetic clasp with integrated pen loop, 192 A5 pages and a folding phone / pen stand. Opens flat due to excellent binding quality.

Print Technique : SC, UV, ENG  
Product size : 21.4 x 15 x 2.3 cm

Preferred Print Location : Bottom

Max Print Size : 130 x 45 mm

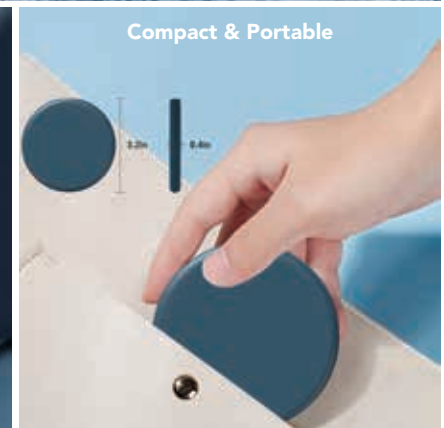
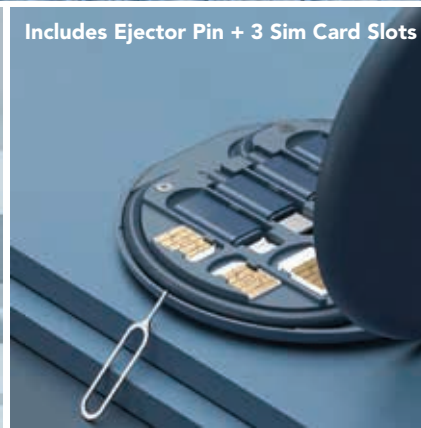

READY STOCK

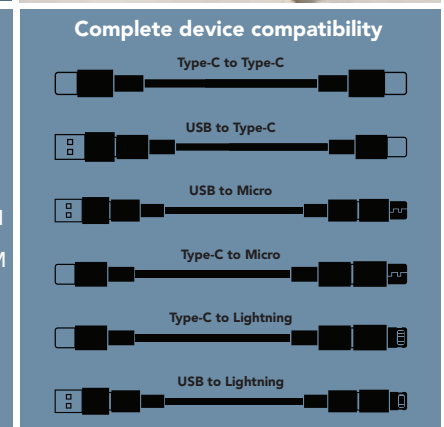
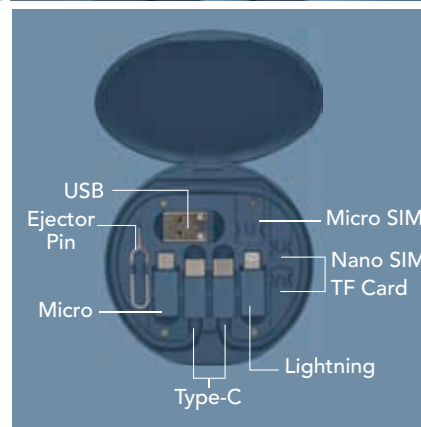

- Sleek Travel-Friendly Cable Case
- Made from Recycled Claim Standard (RCS) Plastic, certified by Intertek
- Magnetic Closing
- Convenient Mobile Holder attachment

TAVIRA

MTST 1126 - Black MTST 1127 - White MTST 1128 - Blue

@MEMORii Multi-cable set with charging cables for all your essential connections: Type C, Lightning, micro USB and USB. Also comes with storage space for ejector pin and 3 slots of micro SIM, nano SIM and TF SIM cards. Tavira is made from RCS-certified recycled plastic and carries all your essential technology accessories in a compact travel size case. It can also serve as a phone or tablet stand for added on-the-go convenience. A great giveaway idea for your customers to remember you by!

Print Technique : SC, UV  
Product Size : ø8.4 x 1 cm

Max Print Size : ø75 mm

Preferred Print Location : Top



# TECH ACCESSORIES



eco-neutral

- > Eco-Friendly 5-in-1 cable
- > Made from Eco-friendly Cork & Wheat Straw
- > Supports Type C, micro USB, Lightning connections



MTST 1102 - VELTEN

eco-neutral Sustainable 5-in-1 charging cable made with cork and wheatstraw material. Comes with Type C, micro USB and Lightning cable outputs and USB input

Print Technique : SC Preferred Print Location : Front Max Print Size : 15 x 30 mm  
Product Size : 23 x 2 x 6 cm

READY STOCK



@MEMORii

- > Eco Bamboo USB Flash drive
- > Useful Accessory



ITFD 1123 - TURDA

@MEMORii Bamboo USB Flash Drive 32GB

Print Technique : UV, SC, ENG Preferred Print Location : Top Max Print Size : 42 X 15 mm  
Product Size : 6.2 x 1.9 x 1.3 cm



Scan Below QR code to watch product video



eco-neutral



EFEN 220 - Couvin

eco-neutral Cardboard cube with lid. Folds out to reveal small sticky notes in 5 different colours (25 sheets per color), included 30 paper clips, 4 pen holder slots, business card slots, a mobile stand and most importantly, a wireless charger. The Wireless charger has a 5W output. A perfect tech desk accessory for the modern desk!!

Print Technique : UV, SC Preferred Print Location : Front Max Print Size : 90 x 90 mm 44 x 17mm  
Product Size : 10.5 x 10 x 10.5 cm Packing Details : 44.5 X 27 X 42.5 cm; 75 pcs/carton; gw/nw: 15 kg/carton



WIRELESS CHARGING



# ECO MOUSEPAD CUM WIRELESS CHARGERS



Giftology



- > 3-in-1 Mousepad, 15W Fast Wireless Charger & Mobile stand
- > Made with eco-friendly natural cork
- > Compact folding design - easy to carry
- > Non-slip base



ITWC 1119 - DEBNO

Giftology Natural Cork Mousepad with built in 15W fast wireless charger, non-slip base and integrated smartphone holder. Compatible with all wireless charging devices. With Type C cable included.

Print Technique : UV, SC Preferred Print Location : Middle Max Print Size : 80 X 200 mm  
Product Size : 26.2 x 20 cm

READY STOCK

@MEMORII



- > Eco Friendly RPET Material
- > 10 Watts Wireless Charger
- > With Mouse pad, Desk Stand
- > Elegant Fabric gives a Rich appearance
- > Folds completely, hence a Travel-friendly accessory



ITWC 154 - VANI

Print Technique : SC, HT  
Product Size : 22 X 28 cm

Preferred Print Location : Front & Back

Max Print Size : (Front) 70 x 30 mm (Back) 260 x 30 mm



## WIRELESS CHARGERS (ECO)



### MAGNETIC is the new trend!

Snap on this magnetic wireless charger to the back of your iPhone 12 to charge your device. The magnets are perfectly aligned for the correct charging position. This wireless charger is also compatible with all Qi devices (iPhone 8 and up and latest Android devices). This ensures this can be used as a regular wireless charger for other phones as well.



- 15W fast charging for iPhone 12
- 15W means 3 times faster wireless charging
- Bamboo - eco friendly
- MAG/SAFE compatible



ITWC 156 - DOMITZ

@MEMORii Domitz is a Magnetic wireless charger with a bamboo casing - 15W wireless capacity for super fast charging.

Print Technique : SC, ENG

Product Size : 6 X 6 X 0.8 cm

Preferred Print Location : Top

Max Print Size : 40 X 40 mm

Packing Details : 43.5 x 42.5 x 25.5 cm ; 200 pcs / carton ; gw / nw : 12.5/13.5 kgs / carton

READY STOCK

## eco-neutral



Phone, Watch, Earbuds charging simultaneously (shown above)

- Simultaneously charge 3 devices
- Fast charging 10W Wireless
- Sustainable Solid Bamboo material



ITWC 1101 - TRABEN

eco-neutral Traben is a 3-in-1 solid bamboo docking station with 10W wireless charging that can simultaneously charge 3 devices - mobile phone, wireless earbuds or AirPods and Apple or Android smartwatch - at once with a single Type-C connection.

(Bottom of Front)

Print Technique : UV, SC, ENG

Preferred Print Location : Bottom of Front

Max Print Size : (Bottom of Front) 160 x 30 mm

(On support Backside) Print Technique : UV, SC, ENG

Preferred Print Location : On support Backside

Max Print Size : (On support Backside) 160 x 95 mm

Product Size : 21 X 18.2 X 13.2 cm

# TRUE WIRELESS STEREO EARBUDS (TWS)



CE RoHS

- > Elegant designer TWS
- > CE-ROHS, MSDS, SCCP free
- > Natural bamboo

- > up to 3 hours play time including 3 size eartips



ITXD 742 - BEBRA

**XDDDESIGN** Let the music flow with these true wireless earbuds in charging case. The bamboo earbuds have a 35 mAh battery and can be re-charged in the 500 mAh charging case within 1 hour. With auto pairing function so easy to pair to your mobile device. Playing time on medium volume about 3 hours. With BT 5.0 for optimal connection. Operating distance up to 10 metres. With pick up and mic. Including 3 size silicone ear tips. Bamboo and ABS material.

Print Technique : UV, ENG Preferred Print Location : Top of Box Max Print Size : 40 X 10 mm  
 Product Size : 2.9 x 3.8 x 8.1 cm Packing Details : 26.5 X 33.5 X 58.5 cm; 100 pcs / carton ; gw / nw : 8.8 kg / carton

READY STOCK



- > Uses Recycled Claim Standard (RSC) plastic, certified by Intertek
- > Bluetooth TWS earbuds with 3 hour playtime + 22 hours backup playtime



CERTIFIED BY INTERTEK  
 Intertek - D26928-R2

TWS made from recycled plastic  
 ITBH 852 - ALAVUS

**MEMORI** This highly useful wireless earbud is a proud possession - made from RSC-Certified recycled materials so that you use it guilt-free. The earbuds have a 40mAh built-in battery to provide 3 hours continuous playtime + 300mAh backup power in the case, with charging time less than an 1 hour. Uses latest Bluetooth 5.0 for an effective operating range of 10 meters.

Print Technique : UV Preferred Print Location : Top Max Print Size : 20 X 30 mm  
 Product Size : 6.2 X 4 x 2.8 cm Packing Details : 34 x 20.5 x 24 cm ; 120 pcs / carton ; gw / nw : 7/8 kg / carton

# Biomaster

## Antimicrobial protection

### How effective is Biomaster?

Very. Biomaster is proven to inhibit the growth of microbes by up to 99.99%.

### Is Biomaster safe?

Yes. It is based on silver ion technology, recognised for centuries with no harmful effects. Biomaster is used in medical, food and water applications.

### How long is Biomaster effective for?

Biomaster is tested to ISO standards and effective for the intended lifetime of the product it's added to. It is built-in and doesn't wear off or leach out.

### Does Biomaster affect a product in any way?

No. You can't see, smell or even taste Biomaster.

### Can a Biomaster-treated polymer be recycled?

Yes, it can be recycled effectively without any complications.

### Does Biomaster use nano-silver technology?

No. We don't use nano technology due to ongoing safety concerns.

### Why is Biomaster better than other silver based antimicrobial additives?

Biomaster pioneered the use of antimicrobial additives, and remains the recognised leader and most trusted supplier of antimicrobial technology for polymers, textiles, paper, paints and coatings.

Scan this QR code to see how Biomaster works on the surface of the product to effectively protect you 24/7



Scan this QR code to learn more about the Anti-Microbial effectiveness and check certifications



## HOW DOES BIOMASTER WORK?

**1** Biomaster binds to the cell wall disrupting growth



**2** The Biomaster ions interfere with enzyme production stopping the cell producing energy



**3** Biomaster interrupts the cell's DNA preventing replication

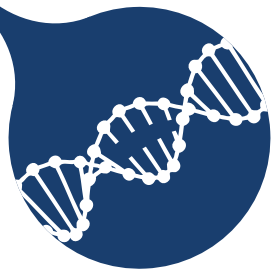

### How do I know if a product is Biomaster protected?

Unless it carries the Biomaster symbol, you don't. Ask before you buy it.

#### Products in this catalog with Added BIOMASTER TECHNOLOGY

1. @memorii Technology products with FSC certified Bamboo
2. Santhome Genuine Leather articles
3. Drinkware - Mugs



[www.biomasterprotected.com](http://www.biomasterprotected.com)

Biomaster is a registered trademark of Addmaster (UK) Ltd.

Use biocides safely. Always read the label and product information.



- > Treated with Biomaster Antimicrobial Technology
- > Made with FSC certified bamboo
- > Fashion 3W Bluetooth Speaker



READY STOCK

ITSP 163 - ESLOV

@MEMORI Natural FSC Certified bamboo 3W speaker with built-in 500mAh lithium battery. With playing time up to 4 hours on one single charge and operating distance of 10m using BT5.0. This product contains Biomaster antimicrobial technology that provides protection against the growth of harmful micro-organisms for the lifetime of the product.

Print Technique : SC, ENG  
Product Size : 12 x 4 x 8 cm

Preferred Print Location : Front Top

Max Print Size : 45 x 10 mm

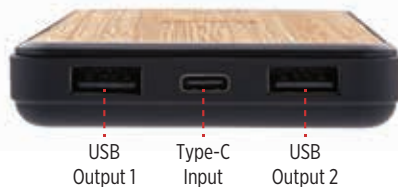

- > Treated with Biomaster Antimicrobial Technology from UK
- > FSC Certified Bamboo
- > Fashion 8000 mAh Wireless Powerbank



ITPB 837 - ASKAS

@MEMORI 8000 mAh heavy-duty powerbank + 5W wireless charger, made with FSC certified natural bamboo material and ABS for a great finish. Smart indicator shows you the remaining energy level. Uses advanced Biomaster anti-microbial technology that continuously protects against harmful micro-organisms for life. Inputs: Micro USB 5V/2A, type C 5V/2A. Output: USB 5V/2.4A. Wireless output: 5W 5V/1A

Print Technique : UV, SC, ENG  
Product Size : 2 X 8 X 15 cm

Preferred Print Location : Front

Max Print Size : 60 X 50 mm

# THE END OF GREENWASHING

Greenwashing refers to false sustainability claims - a growing problem for the modern conscious buyer

We believe true sustainability starts with **TRANSPARENCY & TRACEABILITY**

Our new **CHANGE** collection aims to end greenwashing and lead our industry in a new direction



With every purchase of CHANGE collection products, **a donation is made to Water.org**, a non-profit that provides access to safe water and sanitation. They have helped **over 36 million** people access safe water to date!

**CHANGE.**  
SERIOUS SUSTAINABILITY

*CHANGE Collection is about design, serious sustainability and giving back.*

*All recycled fabrics are certified by the Global Recycled Standard.*

*Gifts that give water: 3% of sale proceeds from this collection is committed by brand owners to Water.org to save lives with safe water*

## OUR IMPACT APRIL 2021 - MARCH 2022



Total Savings



**63,311,594**

LITRES OF WATER SAVED



**251,065**

PLASTIC BOTTLES RE-PURPOSED



**1,752**

PEOPLE PROVIDED WITH LASTING SAFE WATER OR SANITATION THROUGH WATER.ORG



CERTIFIED BY INTERTEK



READY STOCK

- > Made from RCS-Certified Recycled Plastic & FSC-Certified Bamboo
- > Recycled wireless headphones with BT5.3
- > 3% of sales proceeds of each product committed to Water.org
- > 6 hours playtime, and 10m wireless range

SAY NO TO GREENWASHING

*Tell the true story of sustainability with genuinely recycled ABS plastic*

Certified by



CERTIFIED BY INTERTEK

GIFTS THAT GIVE BACK

785 million people - 1 in 9 - lack access to safe water. We are supporting Water.org to change this.

For each CHANGE product sold, 3% of sales is donated by the brand owners to Water.org to save lives with safe water and sanitation



RCS-certified Recycled Bluetooth Headphone

ITBH 1109 - ADORF

@MEMORI Adorf is a CHANGE Collection Recycled (RCS-certified) Bluetooth Wireless Headphone, made from certified recycled plastic and sustainable FSC-certified bamboo. The wireless headphone uses BT 5.3 for super smooth connection and long lasting play-time. The over ear design of the earbuds allows a comfortable and perfect sound experience. The built-in 200 mAh lithium battery allows a play time up to 6 hours and can be fully re-charged in 1.5 hours. Operating distance up to 10 metres. With mic and pick up function. Packed in recycled kraft gift box. This headphone contributes 3% of sales to Water.org - a global NGO that provides millions with access to safe water and sanitation. By giving to Water.org, you are giving a GIFT THAT GIVES BACK.

Print Technique : SC, ENG

Preferred Print Location : Sides

Max Print Size : 48 x 40 mm

Product Size : 16 x 12.5 x 8 cm



RCS-certified Recycled Bluetooth Speaker  
ITSP 1110 - ASPERG

@MEMORI Asperg is a CHANGE Collection Recycled (RCS-certified) Bluetooth 5W Wireless Speaker, made from certified recycled plastic and sustainable FSC-certified bamboo. The wireless speaker uses BT 5.1 for super smooth connection and long lasting play-time. The built-in 1,200 mAh lithium battery allows a play time up to 6 hours. Operating distance up to 10 metres. With mic and pick up function. Packed in recycled kraft gift box. This speaker contributes 3% of sales to Water.org - a global NGO that provides millions with access to safe water and sanitation. By giving to Water.org, you are giving a GIFT THAT GIVES BACK.

Print Technique : SC, UV Preferred Print Location : Front Max Print Size : 65 x 20 mm  
Product Size : 8.8 x ø7.5 cm

- Made from Certified Recycled Plastic & FSC Bamboo
- Recycled wireless speaker with BT5.1
- 3% of sales proceeds of each product committed to Water.org
- 6 hours playtime, and 10m wireless range



CERTIFIED BY INTERTEK



READY STOCK

### SAY NO TO GREENWASHING

*Tell the true story of sustainability with genuinely recycled ABS plastic*

Certified by



### GIFTS THAT GIVE BACK

💧 785 million people - 1 in 9 - lack access to safe water. We are supporting Water.org to change this.

💧 For each CHANGE product sold, **3% of sales is donated** by the brand owners to Water.org to save lives with safe water and sanitation



CERTIFIED BY INTERTEK



- 6-in-1 Cable made from Certified Recycled TPE & FSC Bamboo
- 3% of sales proceeds of each product committed to Water.org



RCS-certified Recycled 6-in-1 Multicable  
MTST 1111 - SULZA

@MEMORI Sulza is a CHANGE Collection Recycled (RCS-certified) 6-in-1 charging cable with Type C, micro USB and Lightning. It can be added to your key ring hence easy to carry along. Packed in a recycled envelope. This cable contributes 3% of sales to Water.org - a global NGO that provides millions with access to safe water and sanitation. By giving to Water.org, you are giving a GIFT THAT GIVES BACK.

Print Technique : UV, SC, ENG Preferred Print Location : Front Max Print Size : ø25 mm  
Product Size : 18.1 x 5.5 x 1 cm







- > 10,000 mAh 5W wireless powerbank
- > Made from Certified Recycled Plastic & FSC Bamboo
- > 3% of sales proceeds of each product committed to Water.org



CERTIFIED BY INTERTEK



RCS-certified Recycled 10000mAh Wireless Powerbank  
ITPB 1112 - ARLES

@MEMORI Arles is a CHANGE Collection Recycled (RCS-certified) 10,000 mAh Wireless Powerbank with 5W wireless charging, made from certified recycled plastic and sustainable FSC-certified bamboo. The powerbank contains a long-lasting grade A 10,000 mAh lithium polymer battery. The wireless charging is compatible with all wireless devices, Android latest generations and iPhone 8 and above. The power indicators will indicate the remaining energy level so you always know when to re-charge. Packed in recycled kraft gift box. This powerbank contributes 3% of sales to Water.org - a global NGO that provides millions with access to safe water and sanitation. By giving to Water.org, you are giving a GIFT THAT GIVES BACK.

Print Technique : SC, ENG Preferred Print Location : Front Top Max Print Size : 127 x 64 mm  
Product Size : 13.6 x 7.1 x 1.7 cm

SAY NO TO GREENWASHING

*Tell the true story of sustainability with genuinely recycled ABS plastic*

Certified by



GIFTS THAT GIVE BACK

- 785 million people - 1 in 9 - lack access to safe water. We are supporting Water.org to change this.
- For each CHANGE product sold, 3% of sales is donated by the brand owners to Water.org to save lives with safe water and sanitation



READY STOCK



- > 15W Wireless Charger (Fast Charging)
- > Made from Certified Recycled Plastic & FSC Bamboo
- > 3% of sales proceeds of each product committed to Water.org
- > Compatible with all wireless charging phones



CERTIFIED BY INTERTEK



RCS-certified Recycled 15w Wireless Charger  
ITWC 1113 - ELSTRA

@MEMORI Elstra is a CHANGE Collection Recycled (RCS-certified) 15W Wireless Charger with fast charging, made from certified recycled plastic and sustainable FSC-certified bamboo. The wireless charging is compatible with all wireless devices, Android latest generations and iPhone 8 and above. Packed in recycled kraft gift box. This wireless charger contributes 3% of sales to Water.org - a global NGO that provides millions with access to safe water and sanitation. By giving to Water.org, you are giving a GIFT THAT GIVES BACK.

Print Technique : SC, ENG Preferred Print Location : Front Top Max Print Size : 95 mm  
Product Size : ø10 x 0.7 cm



QUALITY



READY STOCK



Micro USB Input  
 On/Off Button  
 Standard USB Output  
 LED Indicators to display available power  
 Type-C Input & Output



Built in Type-C Output Cable

Built-in Lightning Cable



- > 10000 mAh Powerbank
- > Built-in Type-C + Micro USB + Lightning Cable
- > Micro USB cable available also
- > Light-up Logo For Optimal Brand Exposure
- > Compact Design & Suction Cups On Back To Securely Hold Your Phone

Scan Below QR code to watch product video



ITPB 1116 - KOVIN

@MEMORii Kovin is a 10000 mah powerbank with light-up logo function for optimal brand exposure. The built-in Lightning and Type C cables & separate Micro USB cable ensure any digital device can be charged without scouting for the cable. Micro USB pin & cable also provided in the gift box. Input & Output- 5V/2.1A, Wireless Output- 5V/1A 5W.

Print Technique : SC, ENG, UV  
 Product Size: 10.6 X 6.8 X 3 cm

Preferred Print Location : Front  
 Packing Details : 37.5 X 13 X 16.5 cms ; 18 pcs / carton ; gw / nw : 4.6 kg / carton



READY STOCK

- > Super Fast Charging 18W
- > 10,000mAh PD powerbank
- > Charge up to 50% under 30 minutes
- > About 2-2.5x fast charging compared to standard powerbanks
- > PD is the latest standard in USB-C super fast charging

ITPB 1122 - KEPNO

@MEMORI Charge all your mobile devices with the fastest charging speed possible with Kepno - a 18W 10,000mAh PD aluminum powerbank. Power Delivery (PD) is the latest charging technology that delivers much higher level of power than any standard powerbank over a USB connection. PD compatible phones includes iPhone 8 and above, Samsung S10+ or later, Google, LG and many others. Kepno PD powerbank can charge 50% power of your latest mobile phones in under 30 minutes! When you're looking for an urgent battery boost, a quick 10-minute charge with Kepno PD might be all you need. With battery indicator lights to show the remaining energy level.

Print Technique : UV, SC, ENG Preferred Print Location : Top Max Print Size : 142 X 55 mm  
 Product Size : 14.5 X 6.5 cm



# POWER BANKS



When the input of Dobble is connected to power supply & output is connected to your phone and once the phone is fully charged, a unique chip automatically cuts off phone charging & starts charging your power bank

XDDDESIGN®

Scan Below QR code to watch product video



Green



Grey

- > 3000 mAh Powerbank
- > Samsung Battery
- > Integrated Connectors



DOBBLE

ITXD 504 - Grey ITXD 506 - Green

XDDDESIGN® Dobble is a two way charger power bank, covered with a microfiber mat. Dobble avoids running out of power by combining charging cables and a powerful 3000mAh Samsung battery in one. Daily use the cable to charge your phone and once full it will automatically charge the internal battery. Output 5V/0,6A, input 5V/1A. Registered design®

Print Technique : UV,SC

Preferred Print Location : Microfiber Mat

Max Print Size : 110 x 50 mm

Product Size : 4.5 x 9 x 3.9 cm

Packing Details : 38 x 20 x 26 cm ; 100 pcs /carton ; gw/nw: 11.6 kg / carton

READY STOCK

## VALUE



- > 4000 mAh Powerbank
- > Edge To Edge Printing Possible
- > With Micro Usb Cable Compartment
- > Notebook Look ; With Sticky Notes



Red

Blue



BUKIE

ITPB 791 - Red ITPB 792 - Blue

MEMORII Bukie is a 4000 mAh powerbank that looks like a notebook and is therefore a perfect business accessory. It comes with sticky notes, a smartphone holder and also contains a cable to connect your smartphone. A nice and playful gift. Input 5V/1A; output 5V/1A.

Print Technique : SC, UV, ENG, EMB Preferred Print Location : Front

Max Print Size : 135 x 92 mm

Product Size : 14 x 9.5 x 1.7 cm

Packing Details : 34.5 X 25.5 X 14.5 cm ; 20 pcs / carton ; gw / nw : 4.8 kg / carton



- > 3100 mAh Portable Power Bank
- > 4 Integrated Connectors Compatible With Most Devices



UD 748 - KEF

Portable Power Bank -Power storage device that comes with 4 adaptors (Apple products, micro USB, mini USB and female USB). Charges your devices on the go and is portable for travel use.

Print Technique : UV, SC Preferred Print Location : Top

Max Print Size : 45 x 15 mm Product Size : 9.5 x 5.5 x 3 cm

Packing Details : 34.x30.5 x 25 cm; 50 pcs/carton; gw/nw: 9.2 kg/carton



@MEMORii



COMMUNICATE YOUR BRAND MESSAGE EFFECTIVELY ON TEMPERED GLASS SURFACE

- > Excellent Branding Space on Tempered Glass Surface
- > Latest Type-C Input & Output
- > Capacity : 10,000 mAh



ITPB 823 - RODEZ

@MEMORii Rodez is a 10000mAh powerbank with a front Scratch-Proof Tempered Glass surface that can be branded edge to edge for optimal brand exposure. The back of the powerbank has a smooth rubberized finish for a comfortable user experience. Dual USB Input-5V/2A, Micro USB Input- 5V/2A, Type-C Input & Output- 5V/2A

Print Technique : UV, SC Preferred Print Location : Front  
 Max Print Size : 90 x 63 mm Product Size : 9 x 6.3 x 2.2 cm  
 Packing Details : 23 x 13 x 23.3 cm ; 21 pcs /carton ; gw/nw: 4.9 kg / carton

@MEMORii



- > Excellent Branding Space On Scratch Proof Tempered Glass Surface
- > Wireless Output: 5W
- > Smooth Rubberised Surface



ITWC 204 - RENNES

@MEMORii Rennes is a 5W Round Wireless Charger with a front Scratch-Proof Tempered Glass surface that can be branded edge to edge for optimal brand exposure. The back of the wireless charger has a smooth rubberized finish for comfortable user experience. Micro USB Input- 5V/1A, Wireless Output: 5W.

Print Technique : UV, SC Preferred Print Location : Front  
 Max Print Size : ø65 mm Product Size : ø7.5 cm  
 Packing Details : 21 x 21 x 25 cm ; 66 pcs /carton ; gw/nw: 4.9 kg / carton

READY STOCK

Giftology



- > 8000 mAh Powerbank
- > Wireless input and output charging

ITPB 812 - APOLDA

Giftology Durable 8000 mAh powerbank for a great promotional campaign. Supports 5W wireless charging and comes with one USB ports to also allow charging by cable. When fully charged it will provide you with enough energy to re-charge your mobile phone up to four times. The power bank contains a long-lasting grade A 8000 mAh high-density lithium polymer battery. The power indicators will indicate the remaining energy level so you always know when to re-charge. Micro USB port-in: 5V/1.5A Output: 5V/2.1A. Wireless output 5W 5V/1A.

Print Technique : UV, SC Preferred Print Location : Front Max Print Size : 40 x 30 mm  
 Product Size : 13.5 x 7.3 x 1.8 cm Packing Details : 21.5 x 20 X 19 cm; 20 pcs/carton; gw/nw: 4.89 kg/carton



Scan Below QR code to watch product video



Integrated cable with 2 in 1 Lightning and micro USB output



- > 5 WATT Wireless Charger
- > 5000 mAh Powerbank
- > Type-C Input & Output For All Modern Phones
- > Suction Cups On Back
- > Integrated Cable With Micro USB And Lightning Output
- > Fast Charge Input And Output

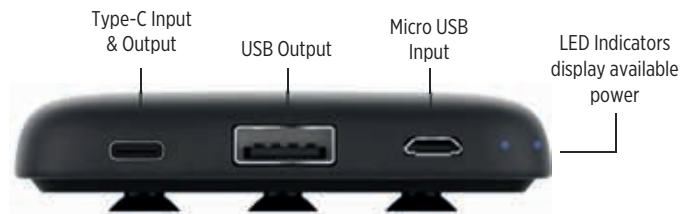

WARSAW

ITPB 464 - Black ITPB 465 - Silver

@MEMORii Warsaw features a USB 2.0 input and Type-C output. The integrated cable has both Micro USB and lightning input. A set of 4 LED indicators display available power. The suction cups will firmly hold your device in place with the power bank which fits right in your palm or your pocket. Input : 5V/2A (Micro), 5V/3A (Type-C); Output : 5V/2A (Standard USB) 1A (Wireless 5 WATT Output).

Print Technique : UV

Preferred Print Location : Front

Max Print Size : 120 x 55 mm

Product Size : 13 x 6.6 x 1.25 cm

Packing Details : 35 X 13 X 21.5 cm ; 20 pcs / carton ; gw / nw : 4.9 kg / carton

READY STOCK

VALUE

QUALITY



- > 8000 mAh Powerbank
- > Type-C Output For All Modern Phones
- > Suction Cups On Back
- > Integrated Cable With Micro USB And Lightning Output
- > Fast Charge Input And Output

Scan Below QR code to watch product video



Integrated cable with 2 in 1 Lightning and micro USB output

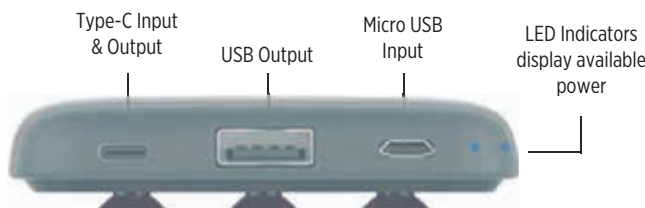

ITPB 462 - SQUIP

@MEMORii Squip is a 8000 mAh powerbank with USB 2.0 input and Type-C output. The integrated cable has both Micro USB and lightning input. A set of 4 LED indicators display available power. The suction cups will firmly hold your device in place with the power bank which fits right in your palm or your pocket. Input : 5V/2A (Micro), 5V/3A (Type-C); Output : 5V/2A (Standard USB).

Print Technique : UV

Preferred Print Location : Front

Max Print Size : 120 x 55 mm

Product Size : 13 x 6.6 x 1.25 cm

Packing Details : 35 X 13 X 21.5 cm ; 20 pcs / carton ; gw / nw : 4.9 kg / carton



@MEMORii



- > Instant note taking on erasable LED writing pad
- > Mousepad with 10W wireless charging
- > Mobile stand and desk accessory gift



ITWC 1108 - SODEN

@MEMORii Desk accessory with in-built 3-in-1 mousepad, 10W wireless charging and a digital reusable writing pad that's great for taking instant erasable notes. Packed in a gift box

Print Technique : UV, SC, EMB  
Product Size : 30 x 21.5 x 1.3 cm

Preferred Print Location : On Mouse pad & On Stand

Max Print Size : (Mousepad) 260 X 150 mm (On Stand) 250 X 50 mm

READY STOCK



VALUE



@MEMORii

- > 5 WATT Wireless Charger
- > Including 100 cm Micro USB Cable
- > Light-Up Logo When Engraved



- > 5 WATT Wireless Charger
- > Supports Latest Android And Ios Devices (Iphone 8 And Up)
- > Charge Your Phone Either In The Landscape (Horizontal) Position Or Portrait (Vertical) Position
- > Foldable Flat For Easy Carry

Scan Below QR code to watch product video



ITWC 203 - CORINTO

@MEMORii Charge your mobile devices without connecting a cable. Just place your mobile phone on the charger and wait for the charging notification to appear. The charging desk stand allows you to decorate your own logo on the pad; Once connected it will Light-Up for optimal exposure. Compatible with all Qi enabled devices like Android latest generation, iPhone 8, 8S and X. Input Type C: 5V/1A. Wireless Output: 5 Watt

Print Technique : UV, SC, ENG

Preferred Print Location : Front

Max Print Size : (LED Light-Up Logo) 40 x 10 mm

Product Size : 8.5 X 7.5 x 10.1 cm

Packing Details : 46.5 x 19.5 x 30.5 cm ; 30 pcs /carton ; gw/nw: 5 kg / carton

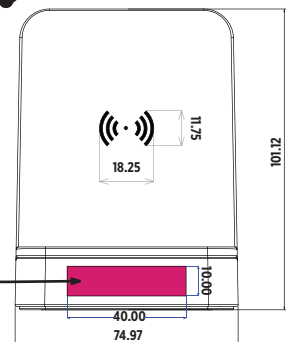

ITWC 151 - RABAT

Giftology Rabat is a 5 Watt Wireless Charger that is perfect for your desk. The integrated cable allows for the wireless charger to be used anywhere. You can place your phone either in the Landscape (Horizontal) Position or Portrait (Vertical) Position on this charger and within seconds the charging notification will appear. Compatible with all Qi enabled devices like Android latest generation, iPhone 8, 8S and X.

Print Technique : UV, EMB, SC

Preferred Print Location : Front

Max Print Size: 20 x 50 mm

Product Size : 32.5 x 9 x 0.7 cm

Packing Details : 43 X 49.5 X 15 cm; 60 pcs/carton; gw/nw: 10.52 kg/carton



# WIRELESS CHARGERS



**XD<sup>X</sup>CLUSIVE<sup>®</sup>**

**CREATIVE**

**QUALITY**



### ITXD 817- ENCORE WIRELESS CHARGER

**XD<sup>X</sup>CLUSIVE<sup>®</sup>** State of the art design wireless charger with transparent designs to expose the A+ grade quality components, high quality charging coil and blue LED charging light. The charging pad supports 10W fast and safe charging to charge your phone twice as fast as most other wireless chargers in the market. Input: 5V/2A Wireless Output: 9V/1.110W. Including 150cm USB to Type C cable for fast charging.

Print Technique: SC, UV  
Product Size: 1.1 x ø10 cm

Preferred Print Location: Front, Down

Max Print Size: 30 X 15 mm

Packing Details: 16.3 x 26 x 63.5 cm ; 50 pcs /carton ; gw/nw: 6.5 kg / carton

**READY STOCK**



**VALUE**

**Giftology**

- > 5 WATT Wireless Charger With Integrated Cable
- > Hub With 2 USB Ports
- > Excellent Edge-To-Edge Branding Space



### ITWC 105 - YSTAD

**Giftology** 5 WATT wireless charger with 2 output USB hub for wired charging. Integrated USB cable allows for the wireless charger to be connected to power source Input: 5V/2A. Wireless Output: 5V/1A, 5W.

Print Technique : UV, SC Print Location : Front Max Print Size : ø60 mm

Product Size : 6 x 6 x 1.6 cm Packing Details : 37.5 X 17 X 29 cm; 100 pcs/carton; gw/nw: 6.15 kg/carton

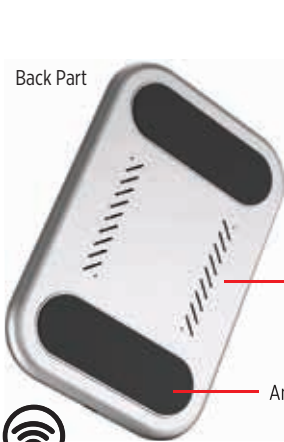

Scan Below QR code to watch product video



Heat Dissipation Design

Anti-Slip Feet



Adjustable holder to fit a phone big or small !!



Can be used on the desk !!

**Giftology**



### ITWC 152 - MEKNES

**Giftology** Meknes is a unique wireless charger that can be used on the desk or can be mounted to the wall. It has a fast wireless charging output of 10 Watts. Also, the adjustable side holders allow for different sizes of phones to be accommodated. Air holes in the side keep the charger cool while charging. Rubber strips ensure stability. Compatible with all Qi enabled devices like Android latest generation, iPhone 8, 8S and X.

Print Technique : UV, SC

Preferred Print Location : Front

Max Print Size : 120 X 80 mm

Product Size : 15.2 x 10.2 x 2.3 cm Packing Details : 42x 56 x 19.5 cm; 60 pcs/carton; gw/nw: 12.3 kg/carton

- > 10WATT Fast Wireless Charger
- > Adjustable Holders To Fit Most Phones

- > Can Be Secured To The Wall Or Placed On The Table
- > Airvents Prevent The Charger From Getting Heated





Detachable 10W Wireless Charging Pad



Joins left or right side using 2 way magnets

READY STOCK



Black

- > Detachable 10W wireless charger and mousepad joins by 2-sided magnets
- > Flexi-attach to left or right side, or use separately
- > With in-built ergonomic wrist rest & pen groove



Dark Grey



Navy Blue



Dark Green



DOBERAN

ITWC 1104 - Black ITWC 1105 - Dark Grey ITWC 1106 - Navy Blue ITWC 1107 - Dark Green

@MEMORii Doberan is a 2-in-1 mousepad with detachable and attachable 10W wireless charger pad. Using 2-sided magnets, the wireless charger pad can be detached and attached to the left or right side of the mousepad, providing a nice adaptability to left or right handed users. The mousepad has an in-built ergonomic wrist rest with cushioning. Packed in a gift box

Print Technique : UV, SC, EMB  
Product Size : 35 x 23 x 2.5 cm

Preferred Print Location : Next to Wrist Support

Max Print Size : 150 X 140 mm



# AN INTELLIGENT MUG WARMER & PHONE WIRELESS CHARGER use at home or in the office.



READY STOCK



Reinforced Porcelain



Smart Safety Feature - **Foreign Object Detection**  
Wireless charger and heating coil remain shut when a foreign object is detected

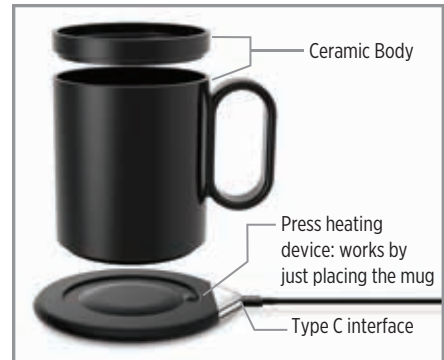

- > Material is safe-to-touch even with ON
- > Continuous 8 hours working
- > Mug 350ml capacity
- > Constant temperature 55°C
- > Supports Qi standard wireless charging of phones incl. Apple & Android upto 10W.



Intelligent Foreign object Recognition identifies metal items that are accidentally place in panel



Wireless / Heating Coaster is waterproof



CRIVITS  
ITHL 534 - WIRELESS CHARGER & CUP WARMER SET

Hans Larsen™ Works with compatible cup / mug only as effective contact points work in tandem with each other. This intelligent base recognises metal foreign objects placed accidentally, and stays shut. Panel is waterproof & safe to touch even when switched on. The radio bottom cooling sheet dissipates heat at high temperature & accumulates heat when temperature is low. Mode of heating - wireless induction. Wireless Coaster can be used as a normal Wireless Charger with mobile phones too!

Print Technique : SC, UV      Print Location : Plate & Front of Mug      Max Print Size : (Plate) 10 x 10 mm  
Product Size : ø8.5 x 10.5 cm      Packing Details : 59 X 41 X 35 cm; 24 pcs/carton; gw/nw: 19.5/18.5 kgs /carton



READY STOCK



Scan Below QR  
code to watch  
product video



- > Powerful Sound Wireless Speaker with 10 hours playtime
- > 5W Wireless Charger
- > Digital Alarm Clock
- > 4000 mAh Built-in powerbank

**ITSP 204 - SOMOTO**

Somoto is a multifunctional portable wireless charger with alarm clock, a powerful 5 W wireless speaker and a 4000 mAh built in powerbank. The speaker uses wireless BT 5.0 for smooth connection and has an operating distance up to 10 metres. With hands-free function and pick up. The 4.000 mAh battery allows you to play music for up to 10 hours or charge your mobile phone twice (depending on the size of your phone's battery) Input: 5V/2A. Output: 5V/1A. Wireless output: 5V/1A 5W.

Print Technique : SC, UV Preferred Print Location : Top Max Print Size : 30 x 50 mm  
Product Size : 10.6 x 8.5 x 8.7 cm Packing Details : 21.5 x 21.5 x 24 cm; 8 pcs/carton; gw/nw: 4.5/5.0kg/carton

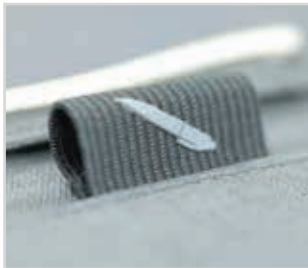

READY STOCK



- > Carry to Meetings - a Travel companion & Desk pad - A modern accessory
- > Laptop & Mobile stand with Wireless Charger, with Notepads for quick notes
- > Mouse pad is an additional functionality
- > Elastic Band for secure closure

ITFO 291 - KAHLA

SANTHOME A modern Folder / Portfolio that works superbly as a desk pad, workstation, wireless charger & mouse pad.

Print Technique : EMB, ENG, UV, SC, FO  
Product Size : 29 X 21 X 2.5 cm

Preferred Print Location : Front  
Max Print Size : 170 X 260 mm  
Packing Details : 53.5 x 46 x 33.3 cm ; 15 pcs /carton ; gw/nw: 13.9 kg / carton

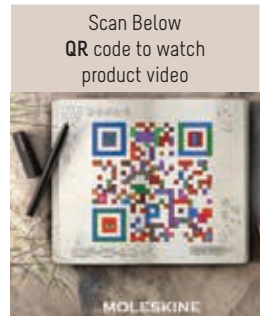

- Smart Notebook (large) with Ncoded paper designed to work with Smart Pen
- Automatically digitizes and transcribes your writing on the Moleskine Notes app
- Smart Tap the email icon to quick share your notes with anyone
- Works offline too, and sync notes later
- In-built voice recorder
- Contains 1 refill and magnetic charger
- Uses FSC® paper - certified forests and other controlled sources.

READY STOCK



**OWMOL 103 - Moleskine Smart Writing Set**

An instant-access kit that gives you a digital copy of every handwritten page. The Smart Writing Set includes the Smart Notebook with its recognizable Moleskine shape and ivory-colored pages, together with the redesigned Smart Pen and Notes App. These tools empower your ideas by building on the creative edge you get from working out ideas on paper. The Moleskine Notes app can be downloaded for free from the App Store™ and Google Play.

Product Size: 26 x 26 x 3 cm



32 GB USB inbuilt  
Elegant gift box



Mobile/tablet stand  
80 sheet/160 pages notebook



# ELEGANT CORPORATE GIFTS





Made for  
**MagSafe**



Grey

Made for  
**MagSafe**



Beige

READY STOCK



PREETZ

ITFO 391 - Beige ITFO 392 - Grey

SANTHOME This Magnetic Smart Notebook Portfolio combines design elegance and latest magnetic charging technology. With an impressive 8000 mAh powerbank, 10W MagSafe magnetic wireless charging, 32GB USB in-built flash drive, numerous ports, card pockets, phone/tablet pocket, pen loop, phone vertical/horizontal stand and an elegant refillable A5 notebook with ivory paper. Snap your phone (iPhone 12 or higher) to the wireless charger and the phone will align perfectly with the magnets inside. The 10W wireless charger is compatible with all Qi devices. Packed in an elegant sliding gift box.

Print Technique : SC, ENG

Preferred Print Location : Front Bottom

Max Print Size : 120 x 50 mm

Product size : 22.5 X 17 X 3 cm



# A5 ORGANIZER POWERBANK

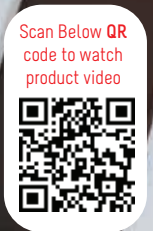

QUALITY

VALUE



Black

- 10000 mAh Powerbank
- A5 Organizer
- Integrated Lightning + Micro USB + Type-C Connectors

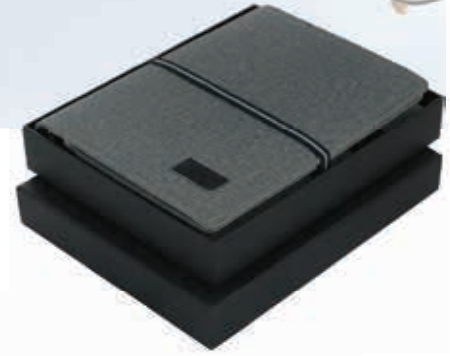

READY STOCK



Grey



Center flap to store mobile phone, cables, travel documents etc



Input charging USB cable      Output charging Micro USB and Type C connectors

Output charging for all latest iPhones



AIGIO  
ITGL 902 - Grey    ITGL 1103 - Black

Giftology Aigio is an A5 notebook organizer with a built in 10000 mAh powerbank. It also has removable 120 pages each of 80 gsm. Integrated USB port for input charging along with Lightning, Micro USB & Type-C connectors capable of charging all available mobile phones & tablets. Aigio can fully charge an iphone or an android device atleast 2-3 times. An elastic band holds and secures everything. Input - 5V/2A; Output - 5V/2A.

Print Technique : SC, ENG, DM      Preferred Print Location : Front Metal Plate      Max Print Size : 20 x 30 mm  
Product Size : 23 X 18.8 X 2.3 cm      Packing Details : 42 x 27 x 46 cm; 20 pcs/carton; gw/nw: 20 kg/carton





READY STOCK



- Fast Charging 10W wireless charging
- Heavy duty 10,000mAh powerbank folder
- Made with premium PU with high frequency welding technology



ITFO 1121 - GUBIN

SANTHOME Gubin is an A5 fast charging wireless powerbank folder and organizer with a built-in 10,000 mAh powerbank and 10W wireless charger. Contains a refillable notebook with 64 sheets, a premium phone/tablet magnetic stand, pen loop and pockets for phones, credit cards, cables, etc.

Print Technique : SC, UV, ENG      Print Location : Bottom      Max Print Size : 130 x 50 mm  
Product Size : 23 x 16.6 x 2.6 cm



# POWER FOLDER SERIES

Pierre Cardin  
PARIS

For consumption in selected East & West African countries



### FEATURES :

- > PIERRE CARDIN Folder with PIERRE CARDIN pen
- > Integrated 8GB USB flash drive
- > 8000mAh built-in powerbank
- > Integrated connectors to charge your digital devices
- > Integrated tablet holder
- > LED lights to display available power
- > PIERRE CARDIN paper pad



LOIRE

ITPC 102 - White/Red

(Folder) Print Technique : SC, ENG

(Pen) Print Technique : UV, SC, ENG

Product Size: 26 x 24 x 3 cm

Preferred Print Location : Front

Preferred Print Location : Barrel

Packing Details : 45 X 28.5 X 31.5 cms ; 10 pcs / carton ; gw / nw : 12.1 kg / carton

Max Print Size : 50 x 30 mm

Max Print Size : 60 x 40 mm

READY STOCK

## QUALITY

For consumption in selected East & West African countries



### FEATURES :

- > PIERRE CARDIN Folder with sliding handle for convenient carry
- > With modern PIERRE CARDIN pen
- > 8000mAh built-in powerbank
- > Integrated connectors to charge your digital devices
- > Integrated tablet holder
- > LED lights to display available power
- > PIERRE CARDIN paper pad

NANTES

ITPC 104 - Red/White

(Folder) Print Technique : SC, ENG

(Pen) Print Technique : UV, SC, ENG

Product Size: 28.7 x 22.5 x 4.5 cm

Preferred Print Location : Front

Preferred Print Location : Barrel

Packing Details : 56 X 26.5 X 32.5 cms ; 10 pcs / carton ; gw / nw : 14.1 kg / carton

Max Print Size : 50 x 30 mm

Max Print Size : 60 x 40 mm



Grey



Black

READY STOCK

- > Made with GRS-certified recycled PET (rPET)
- > Smart 2-in-1 Laptop Holder / Desk Organizer

- > Magnetised laptop stand raises laptops by 7cms
- > 4 smart pockets for your phone and all required accessories



Laptop Organizer



Desk Stand & Organizer

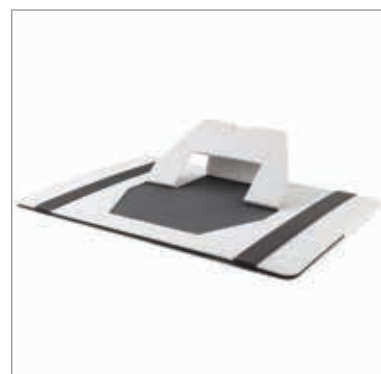

Ergonomic Laptop Stand

ZABKI

LSGL 413 - Black LSGL 414 - Grey

Giftology ZABKI - A stylish, sustainable and functional desk organiser & laptop holder with magnetised stand, ideal for easy work with laptops anywhere. Made of GRS-certified recycled polyester (rPET). Including ball pen loop and smartphone pocket, with 4 additional elastic pockets for storage of multiple gadgets.

Print Technique : SC Preferred Print Location : Front Right Side of Pen loop Max Print Size : 115 X 55 mm

Product Size : 30.5 x 22cm



- > Aluminum folding laptop stand
- > Portable folding - Easy to Carry
- > Adjustable Height and Laptop Angle for optimal neck and back comfort



READY STOCK

ITGL 1117 - SKARA

Giftology Skara is a high quality folding laptop stand made of durable aluminum and including extendable, height-adjustable legs with anti-slip rubber pads for a solid fit to the laptop computer and desk surface. Compact folding size which makes it ideal for carrying with you for travel. Presented in a gift box.

Print Technique : UV, SC, ENG Preferred Print Location : Front Max Print Size : (Both Arms) 75 X 20 mm

Product Size : 25.6 x 4.4 x 1.6 cm



- > Hands-free laptop mount for your phone/tablet
- > Convenient use of dual screens for work or study
- > Contains powerful quality magnets and 3M sticker adhesives

ITGL 1118 - MALMO

Giftology MALMO consists of a metal phone or tablet mount for your laptop. Simply attach the Malmo mount on your laptop using the 3M stickers, and use the 2 additional metal rings on your devices of choice. You can then mount your devices next to your laptop screen using Malmo's powerful magnets, and benefit from hands-free phone/tablet accessibility and convenient use of dual screens. This device helps boost productivity while working, studying, or on the go.

Print Technique : UV, SC, ENG Preferred Print Location : Back Max Print Size : 65 X 23 mm or ø32 mm

Product Size : 12.5 x 3.5 x 0.6 cm



- > Compatible with all wireless charging smartphones due to included magnetic ring
- > Made with powerful N52 magnets

- > Multi-tasking and productivity enhancements possible
- > 15W Fast Wireless Charging while phone is mounted

READY STOCK



**ITGS 1114 - RADLIN**  
 @MEMORI This 3-in-1 kit consists of a metal phone or tablet mount for your laptop, a matching 15W universal magnetic wireless charger that can charge any wireless compatible smartphone and a laptop stand. You can now benefit by raising your laptop for better back and neck posture, while enjoying hands-free phone/tablet accessibility, convenient use of dual screens and fast universal wireless charging - all at the same time. This kit will help boost your productivity while working, studying, or on the go.  
 (Laptop Stand) Print Technique : UV, SC, ENG Max Print Size: (Both Arms) 75 X 20 mm  
 Preferred Print Location : Front  
 (Wireless Charger) Print Technique : UV, SC, ENG Max Print Size : 65 X 23 mm or ø32 mm  
 Preferred Print Location : Back  
 (Mobile Holder) Print Technique : UV, SC, ENG Max Print Size : 50x20mm  
 Preferred Print Location : Back

**ITGS 1115 - DABIE**  
 @MEMORI This 2-in-1 kit consisting of a metal phone or tablet mount for your laptop and a matching 15W universal magnetic wireless charger that can charge any wireless compatible smartphone, while it is mounted alongside your laptop. Both items are made from CNC polished aluminum with N52 magnets inside. The universal magnetic wireless charger comes with an extra magnetic ring that can be attached to any wireless charging smartphone, effectively converting them into a magnetic charging compatible device. You can now benefit from hands-free phone/tablet accessibility, convenient use of dual screens and fast universal wireless charging - all at the same time. This kit will help boost your productivity while working, studying, or on the go.  
 (Wireless Charger) Print Technique : UV, SC, ENG Max Print Size : 65 X 23 mm or ø32 mm  
 Preferred Print Location : Back  
 (Mobile Holder) Print Technique : UV, SC, ENG Max Print Size : 50x20mm  
 Preferred Print Location : Back



# DESK TECH ACCESSORIES



### UD 735 - BREEZE

Expandable, USB powered laptop cooling fan that pushes a constant stream of cool air through your system, ensuring that it remains as cool as possible. Doubles as a Laptop Stand

Print Technique : UV, SC Preferred Print Location : Top Right

Max Print Size : 30 x 20 mm Product Size : 22 x 9 x 2 cm

Packing Details : 47.5 x 35.5 x 22 cm; 48 pcs/carton; gw/nw: 13.37 kg/carton



Multipurpose Mobile Phone Holder

Secured & Strong Grip

### MTGL 301 - TORNIO

MEMORI Tornio is a multipurpose phone holder that can be used to secure your phone to the car air vent or your desktop/laptop. It provides secured grip to the phone on your hand and can be also used as a phone stand.

Print Technique : SC Preferred Print Location : Front

Max Print Size : 20 x 40 mm Product Size : 3 x 26 x 0.3 cm

Packing Details : 47 x 22.5 x 18.5 cm 150 pcs /carton; gw/nw: 6.5 kg/carton

READY STOCK



Comes with above 4 pin / tip system

### ED 447 - EZRA

IDAPT i2Ps an innovative charging solution that eliminates cable clutter. IDAPT's patented interchangeable tip system allows you to safely charge almost any combination of portable devices quickly and easily. It is compatible with more than 5,000 electronic devices and combines style with simplified charging, perfect for today's mobile lifestyle.

Print Technique : SC Preferred Print Location : Front Bottom Center

Print Size : 50 x 30 mm Product Size : 15.3 x 12.3 x 3.5 cm

Packing Details : 58 x 39 x 33 cm; 24 pcs/carton; gw/nw: 14 kg/carton



### ED 448 A - DOCK

IDAPT i3P is an innovative charging solution that eliminates cable clutter. IDAPT's patented interchangeable tip system allows you to safely charge almost any combination of portable devices quickly and easily. It is compatible with more than 5,000 electronic devices and combines style with simplified charging, perfect for everyone's mobile lifestyle

Print Technique : SC Preferred Print Location : Front Bottom Right

Max Print Size : 35 x 20 mm Product Size : 17x 13.5x 3.5 cm

Packing Details : 58 x 39 x 33 cm; 24 pcs/carton; gw/nw: 14 kg/carton

IDAPT IS SUBJECT TO PATENTS AND REGISTERED TRADEMARKS. DEVICES ARE SHOWN FOR ILLUSTRATION PURPOSES ONLY AND ARE NOT INCLUDED.



- > Red Dot Design Award Winner
- > Universal Tablet Holder
- > Notepad Included
- > Perfect Meeting Accessory !!



FO 3325 - AXIS 9-10"

XDDDESIGN® Axis portfolio is made with recycled RPET material and has an integrated universal tablet holder, notepad and storage pockets. Makes for easy Organizing. This unique and patented system makes it possible to fit most 9-10" tablet. Registered design®

Print Technique : SC, HT Preferred Print Location : Front Left  
 Max Print Size : 60 x 190 mm (<100 cm<sup>2</sup>) Product Size : 27.5 x 21 x 3 cm  
 Packing Details : 36 x 33 x 31.3 cm ; 10 pcs /carton ; gw/nw: 6.75 kg / carton

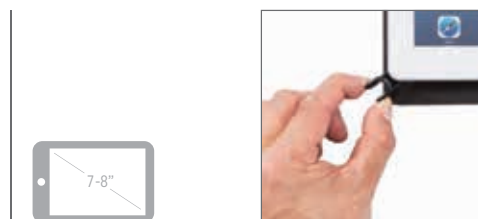

FO 3326 - AXIS 7-8"

XDDDESIGN® Axis portfolio is made with recycled RPET material and has an integrated universal tablet holder, notepad and storage pockets. Organization has never been easier. This unique and patented system makes it possible to fit most 7-8" tablets. Registered design®

Print Technique : SC, HT Preferred Print Location : Front Left  
 Max Print Size : 80 x 240 (<100 cm<sup>2</sup>) Product Size : 21.8 x 15.1 x 2 cm  
 Packing Details : 36 x 34 x 25.60 cm ; 20 pcs /carton ; gw/nw: 8.31 kg / carton

Option of two sizes

READY STOCK



XDDDESIGN®  
GENUINE LEATHER

7-8"



UI 1282 - KOMO 7-8"

XDDDESIGN® Komo Universal Portfolio is a stylish genuine leather portfolio with outer pockets and an integrated universal tablet holder that can be easily propped for presentations. The unique and patented system makes it possible to fit in most 7-8" tablets. Registered design®

Print Technique : SC,ENG Preferred Print Location : Front down Max Print Size : 120 x 40 mm  
 Product Size : 21.8 x 14.4 x 2 cm Packing Details : 46 x 36 x 25 cm ; 18 pcs /carton ; gw/nw: 8.6 kg / carton



# DESK TECH ACCESSORIES



## USB HUB + PHONE STAND

ITMK 122- BATAM

Desk phone holder with USB hub and light up logo and phone stand.  
Print Technique : ENG Preferred Print Location : Front  
Max Print Size : 50 X 10 mm Product Size : 7.6 X 3.4 X 6 cm  
Packing Details : 33.5 X 38 X 35 cm ; 200 pcs / carton ; gw / nw : 10 kg / carton

## XDDESIGN®

### USB HUB



- > 3 USB 2.0 Ports With A Type-C Port
- > Charge Your Device Or Transfer Data
- > Integrated USB Cable

ITXD 802 - FLAT HUB

XDDESIGN® Flat Hub is a Hub with 3 USB 2.0 ports and one type C 2.0 port to charge devices efficiently and to transfer data. With integrated cable to attach it to the USB port of your computer flat hub caters to various devices to charge a device or to transfer data. Made out of aluminium and PP. Registered design®  
Print Technique : UV, SC Preferred Print Location : Front  
Max Print Size : 60 x 17 mm Product Size : 1.3 x 2.5 x 8.7 cm  
Packing Details : 23 x 23 x 37 cm ; 200pcs /carton; gw/nw: 7.5 kg / carton

READY STOCK



Scan Below QR code to watch product video



UD 795 - QUATRO

XDDESIGN® Quatro brings the 4 most common plugs into just one cable: Apple Lightning, Apple Dock, Micro USB and Mini USB. Now you can have them all together on a handy keychain so you'll never be without the right connector. Registered design®  
Print Technique : SC, UV  
Preferred Print Location : Front  
Max Print Size : 25 x 25 mm  
Product Size : 14.5 x 5 x 1 cm  
Packing Details: 36 x 34 x 18 cm ;  
100 pcs/carton ; gw/nw: 9.1 kg / carton



Scan Below QR code to watch product video

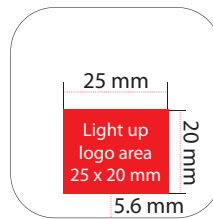

Light-Up Logo When Engraved

750 mAh Emergency Powerbank for mobile phones with Micro USB Input

Integrated 2 in 1 Lightning + Micro USB Cable

Can Be Used For Charging And Data Transfer



ITPB 890 - Bray

Print Technique : UV, SC, ENG  
Preferred Print Location : Front  
Max Print Size : (Light-Up logo) 25 X 20 mm  
Product Size : 5 x 5 x 1.5 cm  
Packing Details: 26 x 30 x 32 cm ;  
240 pcs/carton; gw/nw : 9.97 kg / carton

## Giftology

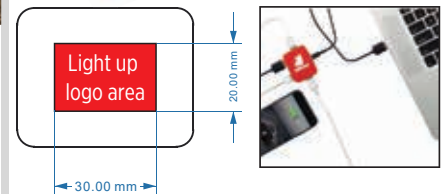

Light up logo area

30.00 mm

20.00 mm

Light-Up Logo When Engraved

USB Hub with 4 USB 2.0 Outputs

Useful Desk Accessory!!



ITGL 793 - OPAVA

Giftology Opava is a USB hub with Micro USB input and 4 USB 2.0 outputs that extend the number of USB ports on your laptop or computer. This cable allows you to decorate the logo in a way that once connected it will light up for optimal brand exposure.  
Input : 5V/1A Output : 5V/1A.  
Print Technique : UV, SC, ENG  
Preferred Print Location : Front  
Max Print Size : Light up logo 30 x 20 mm  
Product Size : 5 X 4 x 1.10 cm  
Packing Details : 75 X 33 X 16 cm ; 400 pcs/carton ;  
gw/nw: 19.6 kg/carton





@MEMORII



- > 2200 mAh Powerbank
- > UV Coated Surface For Smooth Feel And Finish
- > Laser Pointer



ITPB 420 - REY

@MEMORII 2200 mAh powerbank in ABS casing with UV coating including laser pointer. Output 5V/1A, input 5V/800mAh.

Print Technique : SC,UV Preferred Print Location : Center

Max Print Size : 45 x10 mm Product Size : 9.5 x 3 x2 cm

Packing Details : 49x 31 x 40.5 cm ; 80 pcs /carton ; gw/nw: 15.2 kg / carton

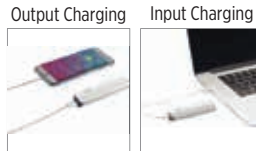

Giftology



- > Convenient eco-friendly device holder
- > Smooth, lacquered bamboo finish



ITGL 1124 - SINTRA

Giftology Bamboo holder for mobile devices (smartphones and tablets). Made with durable bamboo with lacquered finish and includes a slot/holder on both sides

Print Technique : UV, SC, ENG Preferred Print Location : Top

Max Print Size : 48 x 40 mm

Preferred Print Location : Top

Product Size : 8 x 6 x 2 cm

Giftology



BUMAB

ITTA 101- Blue ITTA 102 - White

Giftology Easy to use, portable and flexible USB fan. Can be used in the USB output of the computer but you can also create a mobile fan by inserting it in your power bank. Made out of high-grade silicone material.

Print Technique : UV Preferred Print Location : Front

Max Print Size : 20 x 8 mm Product Size : 14 x 8.5 x 1.4 cm

Packing Details : 56 x 36 x 29 cm ; 357 pcs/carton ; gw/nw: 14.2 kg/carton



ITGL 1125 - VARDO

Giftology Bamboo Phone Grip and Stand with adjustable height

Print Technique : UV, SC, ENG Preferred Print Location : Top

Max Print Size : ø36 mm

Preferred Print Location : Top

Product Size : 0.8 x ø4 cm

READY STOCK



ITPB 450 - POWERDO

Giftology This handy accessory features a 2200 mAh lithium ion Grade A non recycled battery, a USB output and a micro USB input with a cord included. It is compatible with most smartphones and has a telescopic handle with an activation button on the grip. No Bluetooth or remote needed, insert audio jack for power connection. Output: 5 Volts/1 Amp.

Max Print Size : 35 x 40 mm

Print Technique : SC, UV Preferred Print Location : Holder

Product Size : 24 x ø2.3 cm

Packing Details : 37 X 21 X 28.5 cm ; 50 pcs/carton ; gw/nw: 10.5 kg/carton





# AUDIO ACCESSORIES

VALUE



Stereo headset

### WIRELESS SPORTS EARBUDS

Volume Buttons on earpod for easy control

Comfort, Ergonomic Design



ITBH 781 - BEATEX

**@MEMORI** Wireless sport earbuds play your favorite music with built in 100 mAh battery that allows you to use the gadget up to 5 hours. Bluetooth version 4.0. The App is compatible with IOS 9.0 and Android 4.4 and higher.

Print Technique : UV,SC Preferred Print Location : Right and Left Sides  
Max Print Size : 25 X 10 mm Product Size : 3.3 X 1.6 X 5.3 cm  
Packing Details : 38 x 23 x 62.3 cm ; 50 pcs / carton ; gw/nw: 11 kgs/ carton

Giftology

VALUE



Detach to find a USB cord to charge your bluetooth earphone



Wireless Bluetooth Earphones

Comes In A Portable Casing

Control Buttons On The Wire

Playtime : 2 Hrs

Value Deal !!

ITBH 791 - RAPLAY

**Giftology** Raplay is a wireless earbud with quality bluetooth connection. Earbuds with microphone for handsfree calling. A frosted plastic case with a detachable USB Cable further adds to its amazing features.

Print Technique : UV, SC Preferred Print Location : Case  
Max Print Size : 55 x 20 mm Product Size : 10.5 x 3.4 x 2 cm  
Packing Details : 42 x 37 x 13.2 cm; 100 pcs/carton; gw/nw: 6 kg/carton

VALUE



Foam On Earpads For Comfort

1.2m Long Aux Cable

Compact & Lightweight



ITBH 851 - TORUN

**Giftology** Torun is a wired headphone with comfortable foam on the ear pad & 1.2m long aux cable length. The stylish head set is light weight & compact enough to carry or store easily .

Print Technique : UV, SC Preferred Print Location : Side  
Max Print Size : 30 x 30 mm Product Size : 14.5 x 16 x 7 cm  
Packing Details : 61 x 38.5 x 36 cm; 40 pcs/carton; gw/nw: 5.8 kg/carton

XDDDESIGN®

QUALITY



Phone Stand



Headphone jack splitter



Screen Cleaner



Scan Below QR code to watch product video



MT 369 - JAM

**XDDDESIGN®** In our current fast growing mobile world we want compact convenience. The Jam audio multitool delivers both needs with a smartphone/ iPod stand, headphone jack splitter, screen cleaner and cable wrap. All of these items are combined in this small, yet durable, audio tool to enhance your daily life. Registered design®

Print Technique : UV, SC Preferred Print Location : Front  
Max Print Size : 42 x 14 mm Product Size : 8 x 2.2 x 1.8 cm  
Packing Details : 45.6 x 24.5 x 27 cm; 200 pcs/carton; gw/nw: 9 kg / carton

READY STOCK

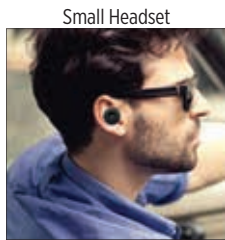

- > Safe Handsfree Experience
- > Bluetooth 4.0 For Smooth Connection
- > Charge And Call While Driving
- > Compatible With All Mobile Phones

**ITCC 701 - FYCAR**

**@MEMORii** Fycar is a unique design car charger with dual USB output and with integrated bluetooth headset that allows a safe hands-free experience whilst driving. The integrated earbud is charged when driving and is ultra-portable due to its small design (20 x 33 mm). The device uses the advanced bluetooth 4.0 connection which ensures a smooth connection and perfect sound quality. The magnetic top of the charger allows you to easily place the earbud back in the dock to charge it. The charger is suitable for all mobile phones. The earbud comes with additional ear tips in different sizes to fit all. Output 5V/1A ; 5V/2.1A

Print Technique : UV, SC, ENG Preferred Print Location : Front Max Print Size : 35 X 7 mm  
Product Size : 8.6 x ø 2 cm Packing Details : 37.5 x 30.5 x 17 cm ; 40 pcs/carton ; gw/nw ; 4.75 kg/carton



READY STOCK



**ITXD 740 - PENRITH**

XD Car charger with Unique design & integrated wireless headset that allows a safe hands-free experience whilst driving. The integrated earbud is charged when driving and is ultra-portable due to its small design (20 x 33 mm). The magnetic top of the charger allows you to easily place the earbud back in the dock to charge it. The charger is suitable for all mobile phones. The earbud comes with additional ear tips in different sizes to get a good seal for all & can be used up to one hour on one single charge and can be fully re-charged in 1.5 hours. Output 5V/1A.

Print Technique : UV, SC, ENG Preferred Print Location : Front  
Max Print Size : 35 x 7 mm Product Size : 8 x ø2 cm  
Packing Details : 38.5 x 33.5 x 30 cm ; 80 pcs /carton ; gw/nw: 5.5 kg / carton



**ITXD 741 - GRAFTON**

XD Car charger with integrated wireless earbud using wireless BT 4.1 for perfect connection. The magnetic top of the charger allows you to easily place the earbud back in the dock to charge it. The charger is suitable for all mobile phones. The earbud comes with additional ear tips in different sizes to get a good seal. ABS material. Input 12-24V/output 2.1A. Registered design®

Print Technique : UV, SC, ENG Preferred Print Location : Front  
Max Print Size : 7 x 20 mm Product Size : 8 x 3 cm  
Packing Details : 55.0 x 35.0 x 21.0 cm ; 96 pcs /carton ; gw/nw: 8.6 kg / carton



CERTIFIED BY INTERTEK



READY STOCK

- > Made from RCS-Certified Recycled Plastic & FSC-Certified Bamboo
- > Recycled wireless headphones with BT5.3
- > 3% of sales proceeds of each product committed to Water.org
- > 6 hours playtime, and 10m wireless range

### SAY NO TO GREENWASHING

**Tell the true story of sustainability with genuinely recycled ABS plastic**

**Certified by**



### GIFTS THAT GIVE BACK

785 million people - 1 in 9 - lack access to safe water. We are supporting Water.org to change this.

For each CHANGE product sold, 3% of sales is donated by the brand owners to Water.org to save lives with safe water and sanitation



RCS-certified Recycled Bluetooth Headphone

ITBH 1109 - ADORF

@MEMORII Adorf is a CHANGE Collection Recycled (RCS-certified) Bluetooth Wireless Headphone, made from certified recycled plastic and sustainable FSC-certified bamboo. The wireless headphone uses BT 5.3 for super smooth connection and long lasting play-time. The over ear design of the earbuds allows a comfortable and perfect sound experience. The built-in 200 mAh lithium battery allows a play time up to 6 hours and can be fully re-charged in 1.5 hours. Operating distance up to 10 metres. With mic and pick up function. Packed in recycled kraft gift box. This headphone contributes 3% of sales to Water.org - a global NGO that provides millions with access to safe water and sanitation. By giving to Water.org, you are giving a GIFT THAT GIVES BACK.

Print Technique : SC, ENG

Preferred Print Location : Sides

Max Print Size : 48 x 40 mm

Product Size : 16 x 12.5 x 8 cm



- > Made from Certified Recycled Plastic & FSC Bamboo
- > Recycled wireless speaker with BT5.1
- > 3% of sales proceeds of each product committed to Water.org
- > 6 hours playtime, and 10m wireless range



CERTIFIED BY INTERTEK



RCS-certified Recycled Bluetooth Speaker  
ITSP 1110 - ASPERG

@MEMORI Asperg is a CHANGE Collection Recycled (RCS-certified) Bluetooth 5W Wireless Speaker, made from certified recycled plastic and sustainable FSC-certified bamboo. The wireless speaker uses BT 5.1 for super smooth connection and long lasting play-time. The built-in 1,200 mAh lithium battery allows a play time up to 6 hours. Operating distance up to 10 metres. With mic and pick up function. Packed in recycled kraft gift box. This speaker contributes 3% of sales to Water.org - a global NGO that provides millions with access to safe water and sanitation. By giving to Water.org, you are giving a GIFT THAT GIVES BACK.

Print Technique : SC, UV Preferred Print Location : Front Max Print Size : 65 x 20 mm  
Product Size : 8.8 x ø7.5 cm

READY STOCK



- > Treated with Biomaster Antimicrobial Technology
- > Made with FSC certified bamboo
- > Fashion 3W Bluetooth Speaker



ITSP 163 - ESLOV

@MEMORI Natural FSC Certified bamboo 3W speaker with built-in 500 mAh lithium battery. With playing time up to 4 hours on one single charge and operating distance of 10m using BT5.0. This product contains Biomaster antimicrobial technology that provides protection against the growth of harmful micro-organisms for the lifetime of the product.

Print Technique : SC, ENG Preferred Print Location : Front Top Max Print Size : 45 x 10 mm  
Product Size : 12 x 4 x 8 cm



# WIRELESS / BLUETOOTH SPEAKERS

## Giftology

VALUE

## Giftology



6 Watts



### Play Modes:

- BT
- TF
- Aux Cable
- USB

ITSP 107 - ASTA

Giftology Asta soundbar with 2\*3W bluetooth speakers and 1200 mAh battery. Functions include Handsfree calling, 3.5mm Line in, USB/TF card play mode. Can also be used with the included audio cable. Packed in a nice gift box.

Print Technique : UV, SC Preferred Print Location : Front  
Max Print Size : 50 x 12 mm Product Size : 31.6 x 5.5 x 4 cm  
Packing Details : 35.5 x 38 x 15.5 cm; 10 pcs/carton; gw/nw: 5 kg/carton



ITSP 802 - BARRIE

Giftology Display your brand effectively with this 3 watt Wireless speaker that has a flat front to allow you to effectively communicate your brand message. With 350mAh battery that allows up to 4 hours playing of your favourite music. Operating distance up to 10 meters. Includes micro cable to charge the speaker. Compatible with all mobile phones.

Print Technique : UV, SC Max Print Size : 100 x 51mm  
Product Size : 10 x 5.1 x 1.3cm Preferred Print Location : Front  
Packing Details : 35 X 23 X 26 cm ; 100 pcs / carton ; gw / nw : 7.3 kg / carton

READY STOCK

VALUE

Dancing Speaker !!



ITMK 108- PLEIKU

Bluetooth Speaker with 3W Power . When music is played, the speaker sets in motion to give a dancing look.

Print Technique : UV, SC Preferred Print Location : Front  
Max Print Size : 35 X 50 mm Product Size : 12 x 8 x 9 cm  
Packing Details : 34 X 26 X 58 cm; 500pcs/carton; gw/nw: 16kg/carton



Light up logo area

25 X 20 mm

ITMK 106 - JUNIK

Compact Bluetooth docking speaker with outside surface especially designed for laser printing to illuminate the marked logo. Bicolor design with smooth finish and bluetooth 3.0 connection, offers 3W power, hands-free function, a micro SD card slot up to 32GB, FM radio function, auxiliary line input via 3.5mm jack connection and non-slip rubber mounts on the base. Compatible with iOS and Android, includes mini USB charging cable, 3.5mm auxiliary jack cable and comes in an attractive design box.

Print Technique : SC, ENG, UV Preferred Print Location : Center  
Max Print Size: 25 X 20 mm (Light-up) Product Size : 5.1 x ø6.2 cm  
Packing Details : 34 X 16 X 34 cm ; 50 pcs / carton ; gw / nw : 7.5 kg / carton



**XD COLLECTION**

- 2500 mAh Powerbank
- 8 GB USB 2.0 Flash Drive
- Excellent Branding Space



White



DUBBO

ITXD 750 - Black ITXD 751 - White

XD Thin 2500 mAh powerbank with detachable 8 GB USB 2.0 flash drive. ABS material.

Output 1V/1A and input 5V/1A. Including micro USB cable. design®

Print Technique : UV, SC Preferred Print Location : Front

Max Print Size : 75 x 55 mm Product Size : 11.3 x 6 x 0.8 cm

Packing Details : 46.5 x 39 x 18.5 cm ; 100 pcs /carton ; gw/nw: 9.5 kg / carton

**@MEMORii**



ITFD 1123 - TURDA

@MEMORii Bamboo USB Flash Drive 32GB

Print Technique : UV, SC, ENG Preferred Print Location : Top

Max Print Size : 42 x 15mm Product Size : 6.2 x 1.9 x 1.3cm

READY STOCK



ITFD 1131 - WOODSTOK

Wood + Crystal USB Flash Drive

Print Technique : ENG Preferred Print Location : Front & Back

Max Print Size : 28 x 13mm Product Size : 6.34 x 1.82 x 1cm



ITFD 1132 - CORKSY

Wood + Glass USB Flash Drive

Print Technique : UV, SC Preferred Print Location : Front & Back

Max Print Size : 19 x 20mm Product Size : 57 x30 x 30cm



ITFD 1133 - ECO FLASH

Environmental Protection USB Flash Drive

Print Technique : UV, SC Preferred Print Location : Front & Back

Max Print Size : 40 x 40mm Product Size : 8.4 x52.5x3.4cm

CUSTOM MADE



ITFD 1134 ABS USB Flash Drive

Print Technique : UV, SC Preferred Print Location : Front & Back

Max Print Size : 45 x 20mm Product Size : 8.8 x5.5x 3cm



ITFD 1135 - VUDY

Metal+Wood Flash Drive

Print Technique : UV, SC, ENG Preferred Print Location : Front & Back

Max Print Size : 48 x 9mm Product Size : 14.35 x2.8x 1.8cm



@MEMORII



- > Works With Google Cardboard (Wgcc) Certified. This Certification Confirms That These Vr Glasses Works With Google Cardboard Apps & Games
- > Lenses Compatible With Google Card Board Ecosystem.
- > Super Compact When Folded And Comes In A Protective Slipcase
- > Ios & Android Compatible

ITVR 725 - POKKIT

@MEMORII Pockit is a foldable VR glass with a carry case. It is WGCC Certified and compatible with all smartphones upto 6". Its 34mm acrylic biconvex lens provides the ultimate VR experience !!

Print Technique : UV,SC Preferred Print Location : Front Max Print Size : 70 x 65 mm  
Product Size : 7.4 x 6.7 x 2 cm Packing Details : 53 x 30 x 39 cm ; 280 pcs/carton ; gw/nw ; 22 kg/carton

READY STOCK



- > Shoot Your Own 3D Photographs And Movies
- > Suitable For Most Mobile Devices



ITXD 701- Lens3D

Universal 3D lens that is suitable for all common Android and iOS models. Simply place the clip on your mobile phone to make your own 3D photographs and movies. The lens is made out of ABS with PU pad to protect your phone.

Print Technique : UV, SC Preferred Print Location : Clip / Top Max Print Size : 45 x 15 mm  
Product Size : 3.8 x 6.7 x 2.5 cm Packing Details : 42 x 21 x 35 cm ; 100 pcs/carton ; gw/nw ; 4.5 kg/carton

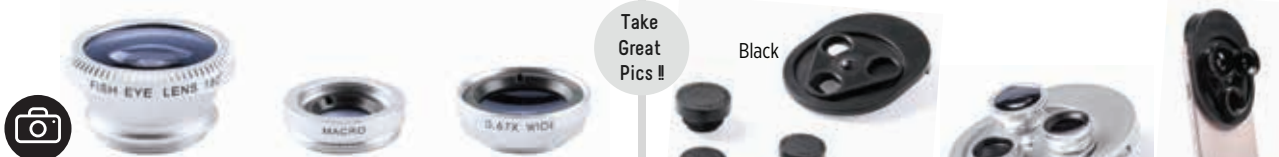

ITMK 124 - BOGOR

Set of 3 universal lenses for smartphone, adjustable to the camera by means of a clip. Aluminum and glass lenses, with fish eye, macro and wide angle effects. With microfibre cleaning cloth and presented in a velvet bag with self-closing laces. Set presented in an attractive design box.

Print Technique : SC Preferred Print Location : Clip Max Print Size : 40 X 30 mm Product Size : 15 x 7 mm  
Packing Details : 31.5 X29 X49 cm ; 100 pcs / carton ; gw / nw : 5kg / carton

DEPOK

ITMK 125 - Black ITMK 126 - Silver

Original 4-in-1 universal lens system for smartphone. Without the need to exchange lenses, it offers macro, CPL, fisheye and wide-angle modes. With safety clamp.

Print Technique : SC Preferred Print Location : Front Max Print Size : 30 X 10 mm Product Box Size : 9.1 X 2.8 X 6.8 cm  
Packing Details : 58 X 36 X 62 cm ; 200 pcs / carton ; gw / nw : 15kg / carton



Webcam cover  
Protect Your Privacy !!



MEDAN

ITMK 190 - Black ITMK 191 - White ITMK 109 - Red ITMK 110-Blue

Print Technique : UV, SC Preferred Print Location : Front Max Print Size : 20 X 8 mm  
Product Size : 3.2 X 1.3 X 0.1 cm Packing Details : 33 x 14 x 42.5 cm ; 10000 pcs/carton ; gw/nw : 4.5 kg/carton





LUXURY



- > Fitness Smart Watch With-Heart Rate Monitor
- > Full Touch Screen-Advanced Chipset
- > Includes Magnetic Wireless Charger
- > Compatible with iOS 9.0, Android 5.0 and above

READY STOCK



Heart rate monitor



Includes Wireless Charging



Syncs with your mobile



Smart voice calling



Bluetooth music playback



Sleep Monitoring



Weather Display



Yoga guide - Mindfulness



Multi Sport Mode



Heart Rate



Long Battery Life  
(7 - 15 days)



Pedometer



Sleep Monitoring



Notifications



1.54" Full  
Touch Screen



Connected GPS



Blood Pressure



Sedentary Reminder



Incoming Call Alert



Music Control



Find My Phone



Stopwatch

WNAT 1130 - THONEX

©MEMORI Live your best life with the Thonex smart watch. Thonex pairs with your smartphone through Bluetooth and comes packed with a range of features: voice calling, social media notifications, voice assistant, music playback, contacts, dialing, alarm, etc. as well as health and fitness features such as pedometer, heart rate monitor, blood oxygen, sleep monitor, etc. Made using a solid zinc alloy casing, and removable silicone straps. Battery life: 7-15 days. Includes a magnetic wireless charger.

Print Technique : ENG, UV

Preferred Print Location : Strap

Max Print Size : 30 x 10 mm

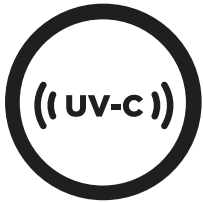

### WHAT IS UVC GERMICIDAL LIGHT?

UVC wavelengths are between 250 and 280 nanometers, making them germicidal – meaning they are capable of inactivating microorganisms, such as bacteria, viruses and protozoa.



### HOW DOES UVC LIGHT WORK ?

The high energy from short wavelength UVC light damages the DNA of bacteria and viruses thereby preventing replication and ability to infect.



### OUR UVC DISINFECTION PRODUCT RANGE

All our UVC products are mercury free and hence environmental friendly. Our products have been tested to be effective in disinfecting 99.9% bacteria such as E. Coli and Staphylococcus.

READY STOCK



- > UV-C Kills 99.9% bacteria
- > External Material is Anti-Microbial
- > Sterilise on - the - go
- > Use your own powerbank / power source or check with us for our range of powerbanks ( Pages 79 to 94 )
- > Non - Toxic; Without Mercury

**ITSN 102 - VADUZ**  
 SANTHOME PROTECT UV-C steriliser pouch that kills up to 99.9% of the bacteria on the item kept inside the pouch. Place objects like phone, earbuds, jewellery, watches and facemask inside the pouch and connect to a charging source such as a laptop or powerbank (for up to 5 min) to 100% sterilise them using UV-C technology. The external material of the pouch is treated with Antimicrobial agents for extra safety. The 2 UV-C LED light inside is non-toxic and made without mercury (beware of many UV lamps in the market) The lights have a lifecycle of 10.000 hours.  
 Print Technique : SC Preferred Print Location : Front Pocket Max Print Size : 75 X 70 mm  
 Product Size : 20 X 11.5 X 3 cm Packing Details : 44 x 47 x 28 cm ; 40 pcs / carton ; gw / nw : 9.74 kg / carton



- > UV-C Kills 99.9% bacteria
- > 2 different zippered compartments, for UV-C & for holding travel & daily accessories
- > Sterilise on - the - go
- > Use your own powerbank / power source or check with us for our range of powerbanks ( Pages 94 to 100 )
- > Non - Toxic; Without Mercury



ITSN 104 - HABRY

SANTHOME  
PROTECT

Everyday use pouch that keeps your daily articles SAFE and HYGIENIC. This pouch has a special compartment with UV-C light that kills 99.9% bacteria on the item kept in the compartment. This UV-C compartment can help you with sterilizing your currency, passport, boarding pass, phone etc that are generally prone to multiple contact with bacterial surfaces by just connecting a cable provided on the back pocket to a power source such as laptop or powerbank. Another zipper compartment features- a zipper pocket for keys, currency, coins etc., pocket to hold multiple passports and has space for your everyday electronic accessories. Packed in a Santhome gift box.

Print Technique : SC, HT

Preferred Print Location : Front Bottom

Max Print Size : 75 X 70 mm

Product Size : 21.5 X 13 X 4.5 cm Packing Details : 45.7x 31.5 x 48.4 cm ; 28 pcs / carton ; gw / nw : 13.2/14.2 kg / carton

READY STOCK

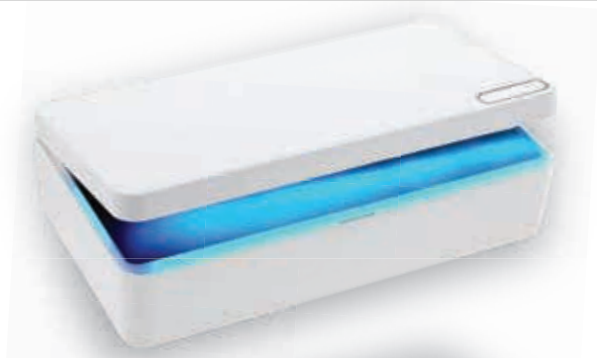

- > Kills upto 99.9% Bacteria
- > 90 Seconds Quick Clean or 5 Minutes Complete Clean



ITSN 103 - HORKI

SANTHOME  
PROTECT

UV-C steriliser that kills up to 99.9% of the bacteria placed inside the device. Simply place objects like earbuds, jewellery, watches and facemask inside the steriliser to sterilise them using UV-C technology. You can choose to do a quick clean in 90 seconds or a complete clean in 5 minutes. The 2 UV-C LED light inside is non-toxic and made without mercury unlike many unsafe UV lamps in the market. The design will also ensure that the UV-C led light will switch off automatically when the box is opened so the user will not be exposed to the UV-C light. The lights have a lifecycle of 10,000 hours.

Print Technique : UV, SC

Preferred Print Location : Top

Max Print Size : 60 x 40 mm

Product Size : 4.3 x 12.6 x 20.4 cm



# WIRELESS CHARGER & UV-C STERILISER BOX

# SANTHOME PROTECT



READY STOCK



- Kills upto 99.9% Bacteria
- 90 Seconds Quick Clean or 5 Minutes Complete Clean
- Built-in 5W Wireless Charger



ITSN 101 - TIGRE

**SANTHOME PROTECT** Multifunction UV-C steriliser that kills up to 99.9% of the bacteria placed inside the device. Simply place objects like earbuds, Jewellery, watches and facemask inside the steriliser to sterilise them using UV-C technology. You can choose to do a quick clean in 90 seconds or a complete clean in 5 minutes. The 2 UV-C LED light inside is non-toxic and made without mercury unlike many unsafe UV lamps in the market. The design will also ensure that the UV-C led light will switchoff automatically when the box is opened so the user will not be exposed to the UV-C light. The lights have a lifecycle of 10,000 hours. On top of the steriliser is a 5W wireless charger to charge your mobile device. Including 100 cm PVC free TPE type C cable. Input: 5V/1.5A; Output: 5/1A - 5W.

Print Technique : UV, SC Preferred Print Location : Top Left Max Print Size : 60 X60 mm  
 Product Size : 4.3 x 12.6 x 20.4 cm Packing Details : 57.5 x 36.5 x 31 cm ; 28 pcs / carton ; gw / nw : 11 / 11.8kg / carton



READY STOCK

- 
- 
- 
- 
- 



ITBH 101 - SKOLE

@MEMORii Let the music flow with these true wireless earbuds in a charging case. Equipped with UV sterilization, this TWS is cleaner and safer to use. Simply put the earbuds in the charging case and the UV will automatically sterilize the bacteria for 90 seconds. While the case is opened in the progress of sanitizing, the process will be stopped immediately to protect the user from harmful UV-C light. The earbuds have a 35 mAh battery and can be re-charged in the 400 mAh charging case. With auto pairing function so easy to pair to your mobile device. Playing time on medium volume about 2 hours. With BT 5.0 for optimal connection. Operating distance up to 10 metres. With pick up and mic.

Print Technique : SC

Preferred Print Location : Front Pocket

Max Print Size : 75 X 70 mm

Product Size : 5.25 X 4.9 X 2.9 cm

# Biomaster

## Antimicrobial protection

### How effective is Biomaster?

Very. Biomaster is proven to inhibit the growth of microbes by up to 99.99%.

### Is Biomaster safe?

Yes. It is based on silver ion technology, recognised for centuries with no harmful effects. Biomaster is used in medical, food and water applications.

### How long is Biomaster effective for?

Biomaster is tested to ISO standards and effective for the intended lifetime of the product it's added to. It is built-in and doesn't wear off or leach out.

### Does Biomaster affect a product in any way?

No. You can't see, smell or even taste Biomaster.

### Can a Biomaster-treated polymer be recycled?

Yes, it can be recycled effectively without any complications.

### Does Biomaster use nano-silver technology?

No. We don't use nano technology due to ongoing safety concerns.

### Why is Biomaster better than other silver based antimicrobial additives?

Biomaster pioneered the use of antimicrobial additives, and remains the recognised leader and most trusted supplier of antimicrobial technology for polymers, textiles, paper, paints and coatings.

Scan this QR code to see how Biomaster works on the surface of the product to effectively protect you 24/7



Scan this QR code to learn more about the Anti-Microbial effectiveness and check certifications



## HOW DOES BIOMASTER WORK?

**1** Biomaster binds to the cell wall disrupting growth



**2** The Biomaster ions interfere with enzyme production stopping the cell producing energy



**3** Biomaster interrupts the cell's DNA preventing replication

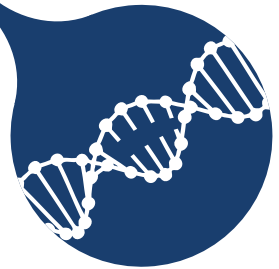

### How do I know if a product is Biomaster protected?

Unless it carries the Biomaster symbol, you don't. Ask before you buy it.

#### Products in this catalog with Added BIOMASTER TECHNOLOGY

1. @memorii Technology products with FSC certified Bamboo
2. Santhome Genuine Leather articles
3. Drinkware - Mugs



[www.biomasterprotected.com](http://www.biomasterprotected.com)

Biomaster is a registered trademark of Addmaster (UK) Ltd.

Use biocides safely. Always read the label and product information.



- > Treated with Biomaster Antimicrobial Technology
- > Made with FSC certified bamboo
- > Fashion 3W Bluetooth Speaker



READY STOCK

ITSP 163 - ESLOV

@MEMORI Natural FSC Certified bamboo 3W speaker with built-in 500 mAh lithium battery. With playing time up to 4 hours on one single charge and operating distance of 10m using BT5.0. This product contains Biomaster antimicrobial technology that provides protection against the growth of harmful micro-organisms for the lifetime of the product.

Print Technique : SC, ENG  
Product Size : 12 x 4 x 8 cm

Preferred Print Location : Front Top

Max Print Size : 45 x 10 mm

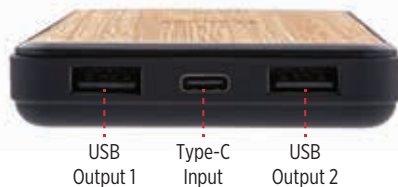

- > Treated with Biomaster Antimicrobial Technology from UK
- > FSC Certified Bamboo
- > Fashion 8000 mAh Wireless Powerbank



ITPB 837 - ASKAS

@MEMORI 8000 mAh heavy-duty powerbank + 5W wireless charger, made with FSC certified natural bamboo material and ABS for a great finish. Smart indicator shows you the remaining energy level. Uses advanced Biomaster anti-microbial technology that continuously protects against harmful micro-organisms for life. Inputs: Micro USB 5V/2A, type C 5V/2A. Output: USB 5V/2.4A. Wireless output: 5W 5V/1A

Print Technique : UV, SC, ENG  
Product Size : 2 X 8 X 15 cm

Preferred Print Location : Front

Max Print Size : 60 X 50 mm



# ANTIMICROBIAL COFFEE TUMBLER



Black



White



Blue

READY STOCK

- Classic universal design
- Contains Biomaster lifetime antimicrobial
- Insulated 250ml mug



## CELLE

DW XD 731 - Black DW XD 732 - White DW XD 733 - Blue

This simplistic designed stainless steel tumbler is not only aesthetically beautiful but is also protected with Biomaster, an Anti-Microbial agent that provides a second line of defence against harmful bacteria. The body and lid are both treated and it's IN the product, not ON the product which will give you permanent protection. This product is tested in accordance with ISO 22196 for Anti-Microbial effectiveness. Biomaster does not affect the recyclability of the item. The product also includes Verimaster a unique tracer that is built into the material to prove that the item is treated with Biomaster. With closable lid. PP inner, stainless steel outer. Capacity 250ml. BPA free.

Print Technique : UV, SC, ENG  
Product Size : 10.5 x 9.2 x 8.5 cm

Preferred Print Location : Front Max Print Size : (UV & ENG) 2.5 x 7 cm (SC) 8 x 5 cm  
Packing Details : 60 x 40 x 15 cm; 24 pcs/carton; gw/nw: 4.3 kg/carton





READY STOCK

- Designer Masks From XDDESIGN, Holland
- VIRALOFF® Technology for Protection
- Built for 1,000 Hours of Usage



Layers



Filter

TALSI

HWXD 171 - Black    HWXD 173 - Navy Blue

**XDDESIGN** This comfortable XD DESIGN face mask is made for every face. Lightweight three-layer design; The polyester front layer is treated with ViralOff®, a technology that removes 99% of the viruses in 2 hours. The middle layer contains a unique laboratory tested Hyproof® Nanofibre filter. This filter has a filtering efficiency of 95%. The inner layer is made of polyester. With three-dimensional chin structure and nose bridge for easy breathing. This set includes: 1 reusable and washable face mask, 5 reusable filters, 1 storage pouch. This device is not a medical device within the meaning of Regulation EU / 2017/745 (surgical masks) nor is it personal protective equipment within the meaning of Regulation EU / 2016/425 (filter masks type FFP2). Registered design®

Print Technique : SC , HT

Preferred Print Location : Right Side

Max Print Size : 60 X 40 mm

Product Size : 18 x 2 x 13.5 cm

Packing Details : 62 x 40 x 32 cm ; 180 pcs / carton ; gw / nw : 13 kg / carton



# REUSABLE NON-MEDICAL FACE MASK

## 50X

REUSABLE & MACHINE WASHABLE WITH GUARANTEE OVER 99% ANTIBACTERIAL RATE

## 100%

ECO-FRIENDLY COTTON

## > 95%

BACTERIAL FILTRATION EFFICIENCY (BFE) FOR PARTICLES > 3 MICROMETER

ADJUSTABLE EARLOOPS  
ONE SIZE FITS ALL



Eco Friendly Cotton



MCMS 105 - REPS

SANTHOME PROTECT Reusable Non-Medical 2 layer cotton face mask that is treated with Silvadur TM (A DuPont product) antibacterial agent. Comfortable daily use masks that protect you and do not harm the environment!

Print Technique : SC , HT

Preferred Print Location : Right Side

Max Print Size : 60 X 40 mm

Packing Details : 57 x 40 x 20 cm ; 600 pcs / carton ; gw / nw : 9.20 kg / carton

READY STOCK



Grey/Black Kids



Navy Blue/Grey Kids



MARONI

HWSN 192 K - Grey/Black - Kids HWSN 193 K - Navy Blue/Grey - Kids

SANTHOME PROTECT Reusable face mask with 6 layer triple filtration system. The comfortable design with adjustable nose clip, soft elastic ear loops and soft materials that prevent heat built-up ensures this mask can be used for a long time. Certified Bacterial Filtration Efficiency and Particulate Filtration efficiency of over 95% (>3 micron). Reusable upto 30 washes.

Print Technique : SC, HT

Preferred Print Location : Side

Max Print Size : (Medium) 40 X 50 mm (Kids)

Product Size : Medium 20 X 13 cm / Kids

Packing Details : 63.5 x 56 x 33 cm ; 500 pcs / carton ; gw / nw : 15.22 kg / carton

## Safety( Isolation ) Goggles

Anti-splash, anti-fog and anti-dust



- > Anti-splash, anti-fog and anti-dust
- > 100% optically clear and 180 vision
- > Fully enclosed with 4 indirect valves
- > UV protected

MCSG 974 - ROCHOR

Specifications:

Lens: PC ; Frame : PVC; Weight: 48g /pc Optional class 1

Certification:

CE EN 166 1B 3, FDA. ISO9001

Application:

Hospitals, Clinics, Medical, Manufacturing, Construction, Mining, Oil and gas

## MASK EXTENSION STRAP

- > Application : Suitable for most of the ear-mounted masks to reduce the pressure and fatigue on the ears.
- > Design : There are 3 adjustable positions to clip the mask on the neck or the back of the head and free the ears from the pressure

> Your Logo : What better way to be in the minds of your customers than an accessory having your logo and required to be used daily



MCMS 103 - Black MCMS 104 - White



Giftology

ANTI-MICROBIAL TOUCHLESS  
KEYHOLDER



MSKC 411 - SOROCA

Giftology Handy Keychain with naturally anti-bacterial brass (over 62% Copper) tip that provides protection against harmful micro-organisms. The tip can be used to push lift buttons or ATM buttons thereby avoiding direct contact. When the tip is not in use, the foam inside can be soaked with disinfectant to sanitize the tip. Packed in a box.

Print Technique : UV, SC, ENG Preferred Print Location : Barrel  
Max Print Size : 40 X 7 mm Product Size : 10.2 X ø1 cm

ABS ( ANTI-MICROBIAL TREATED ) KEYRING TOOL



White



Red



Blue



Green

MASTY

MTGL 843 - White MTGL 844 - Blue MTGL 845-Red MTGL 846-Green

Giftology A robust hygiene tool that allows the user to open doors and push buttons without any direct contact. Manufactured from strengthened materials for extra durability. This product contains antimicrobial technology that provides protection against the growth of harmful micro-organisms for the lifetime of the product. Supplied as a keychain.

Print Technique : UV, SC Preferred Print Location : Front  
Max Print Size : 30 X 6 mm Product Size : 8 X 3.5 X 0.4 cm  
Packing Details : 39.5 x 21.5 x 39 cm ; 1000 pcs / carton ; gw / nw : 10.3 kg / carton

READY STOCK

- > Treated with Japanese Antibacterial agent produced with
- > Great Branding Space on clip



- > Treated for bacterial effectiveness
- > 1200m writing length
- > German Dokumental® Ink.



WIPP 820 - LEOVA

Giftology Sharing a pen means also transferring disease causing bacteria. Worried? Dont be! Because this pen is made from antibacterial agents produced with SIAA mark. With 99% Bacteriostatic Rate, these pens prevent growth and multiplication of bacteria on their surface.

Print Technique : SC, UV Preferred Print Location : Clip  
Max Print Size : 35 X 7 mm Product Size : 14 x ø1cm  
Packing Details : 54x 34 x 18 cm ; 500 pcs /carton ; gw/nw : 5/4 kg /carton



DEPOK  
WIPP 822 - Blue

Giftology Carbon pattern click action ballpoint pen that is treated with Antibacterial Silver-Ion technology in accordance with ISO 22196. With 1200 meter writing length and German Dokumental® Ink.  
Print Technique : UV, SC Preferred Print Location : Clip  
Max Print Size : 8 X 35 mm Product Size : 14 x ø1cm

ANTI-BACTERIAL



BILLUND  
WIMP 261 - Black WIMP 262 - Blue  
WIMP 263 - Red WIMP 264 - Green

Giftology Anti-Bacterial Metal Ballpoint pen with soft rubberized finish and matt gun metal trims. Especially designed for laser engraving, including a special coating for your logo. With 1200 m writing length and German Dokumental® Ink.

Print Technique : ENG, UV, SC Preferred Print Location : Barrel  
Max Print Size : 50 x 6 mm Product Size : 13.7 x ø1 cm  
Packing Details : 34 x 29 x 16cm ; 500pcs /carton ; gw/nw: 9.5/10.5kg /carton



# ANTI-BACTERIAL NOTEBOOKS & BACKPACKS

- > Cover made from recycled plastic (rPET) & treated with silver-ion Anti-Bacterial Technology
- > FSC Certified Paper
- > A5 Ruled Notebook, 160 Pages



## SANTHOME PROTECT

**This Notebook Cares for You**  
Functional & Safe notebook that protects you against harmful microbes that may adhere to its surface. Kills 99.9% bacteria using Silver-Ion Technology.

**This Notebook Loves Trees**  
Paper used to make this notebook is FSC certified. FSC certified paper is paper that has been harvested in a socially and environmentally responsible manner. By using a FSC certified paper, you are helping to ensure our forests are alive for generations to come.

**This Notebook Cares for the Environment**  
The fabric cover of the notebook is made using recycled post-consumer plastic. The rPET material itself is sourced from a Global Recycled Standard (GRS) certified factory. GRS certifies and communicates truth in materials and support for a circular economy that reduces waste by using it to make new products.

A notebook that is proudly made and a notebook you would proudly use!



### BOOKMARK



Black

Navy Blue

Grey

ORSHA

NBSN 341 - Black NBSN 342 - Grey NBSN 343 - Navy Blue

**SANTHOME PROTECT** A notebook that cares for you and for the environment. The cover of the notebook is made from recycled plastic (rPET) in a GRS Certified factory that complies with global recycling standards and is treated with anti-bacterial technology to provide protection against the growth of harmful bacteria. The paper used in this notebook is acid-free and FSC Certified. A5 notebook with 160 ruled pages each of 70 gsm

Print Technique : SC, HT Preferred Print Location : Front Max Print Size : 120 X 200 mm

Product Size : 14 X 21 X 1.4 cm Packing Details : ( Black ) 36.5 X 33 X 24 cm ; (Black = 50 pcs) / carton ; (Grey& navy Blue = 59 pcs / carton gw / nw : 13.3 kg / carton

READY STOCK

## Giftology



Blue



Black



Grey



> Exterior Fabric is Anti-Bacterial



MALACCA

BPGL 671 - Black BPGL 672 - Grey BPGL 673 - Blue

**Giftology** Everyday backpack with Antibacterial exterior fabric to ensure that your backpack is free from harmful disease-causing bacteria. Commute and travel with this backpack without worrying about accumulating bacteria on your backpack during multiple contact with foreign surfaces. This backpack features a 15" laptop compartment, a USB external charging port, easy to access 2 front compartments and a water bottle pocket on the outside.

Print Technique : SC Preferred Print Location : Front Max Print Size : 200 X 150 mm

Product size : 42 X 30 X 10 cm Packing Details : 60 x 45 x 42 cm ; 25 pcs /carton ; gw/nw: 13/12 kg/ carton



Red



Ink Blue



Black



Item: SALAMA | Content : 100% Polyester  
 Measurement : Gulf | Sizes Available : S, M, L, XL, XXL, 3XL

Print Technique :

- 1 Screen Printing
- 2 Heat Transfer
- 3 Embroidery

Preferred Print Location : Max Print Size:  
 Left Chest Area / Sleeve 80 x 50 mm

Packing:

\* Packing details may have ± 10% variation based on size breakup

Care Instructions:



\* Printing Limitations prevent exact fabric and color representation.  
 The shades in the lots may differ due to lot-to-lot variations.  
 The difference is no more than internationally accepted norms of the garments trade.

READY STOCK

Hans Larsen™



- > Releases pressure off the ear when wearing mask!! Helps fight Covid-19
- > Classic cotton cap



HWHL 188 - KATHU

Hans Larsen™ Heavy Brushed 6 Panel Classic cotton cap with button that allow you to put the mask straps around the buttons instead of your ears, a more comfortable way to wear face cover!

Print Technique : HT, SC, EMROIDERY Preferred Print Location : Front Max Print Size : 80 x 30 mm



THE IMPROVED BDNC POLO



THE  
ANTI-MICROBIAL  
DRYnCOOL  
EXECUTIVE  
POLO SHIRT



Red



White

READY STOCK

Item : SECURE | Content : Dryncool fabric  
Measurement : Gulf | Sizes Available : S, M, L, XL, XXL, 3XL

SILAIDE 100 Anti Microbial Polo  
Premium executive wear  
No-fuss performance.  
Creaseless.  
Dryncool Moisture Management Technology



Print Technique :

- 1 Screen Printing
- 2 Heat Transfer
- 3 Embroidery

Preferred Print Location : Max Print Size:

Left Chest Area / Sleeve 80 x 50 mm

Care Instructions:



Packing:

53 x 33 x 45cm; 50 pcs/carton ; gw/nw: 15/16kg / carton  
\* Packing details may have ± 10% variation based on size breakup

\* Printing Limitations prevent exact fabric and color representation.  
The shades in the lots may differ due to lot-to-lot variations.  
The difference is no more than internationally accepted norms of the garments trade.

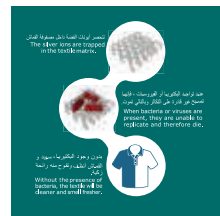
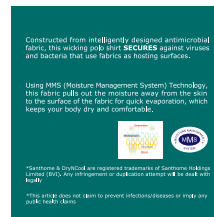

Tagless label



Side slits with bartack

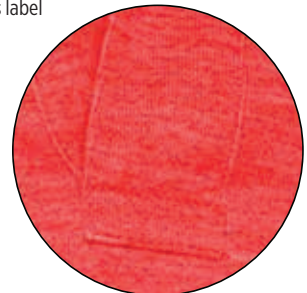

Double placket



HEIQ SWISS  
TECHNOLOGY

VIROBLOCK  
ANTIVIRAL  
PROTECTION



White



Black



Navy

READY STOCK

Item: Shield | Content: 100% Polyester  
Measurement : Gulf | Sizes Available : S, M, L, XL, XXL, 3XL

VIROBLOCK ANTI VIRAL PROTECTION

- Executive wear.
- Premium quality.
- No-fuss performance.
- Creaseless.

Print Technique :

- 1 Screen Printing
- 2 Heat Transfer
- 3 Embroidery

Preferred Print Location : Max Print Size:

Left Chest Area / Sleeve 80 x 50 mm

Care Instructions:



Packing:

- 51 x 36 x 41cm ; 50 pcs /carton ; gw/nw: 14/12kg / carton
- \* Packing details may have ± 10% variation based on size breakup

\* Printing Limitations prevent exact fabric and color representation.  
The shades in the lots may differ due to lot-to-lot variations.  
The difference is no more than internationally accepted norms of the garments trade.

Constructed from intelligently designed antimicrobial fabric, this wicking polo shirt **SHIELDS** against viruses and bacteria that use fabrics as hosting surfaces.

HEIQ Viroblock product is EU BPR and US FIFRA compliant

\*Santhome & DrynCool are registered trademarks of Santhome Holdings Limited (SHTL). Any infringement or duplication attempt will be dealt with legally.

\*This article does not claim to prevent infectious diseases, or make any public health claims

مصنوع من قماش معزز للميكروبات معمم بذلك، تم تصميمه لجلب أفضل النتائج للمساعد للفيروسات والبكتيريا التي تستخدم الأقمشة كسطح للتواجد.

منح هيك فيرو بلاك متوافق مع قانون منتجات المبيدات الحيوية للإتحاد الأوروبي ، ومع القانون الاتحادي للمبيدات الحشرية ، ومبيدات الفطريات، ومبيدات الفوارس في الولايات المتحدة.

\*"Santhome & Dryn Cool" هي علامة تجارية مسجلة لشركة سانثوم هولدينجز المحدودة (إم.إل.إس.إل.إم.إل). أي انتهاك أو محاولة لتقليد اسم المنتج أو علامة التسجيل، سيتم التعامل مع أي محاولة لتقليد أو انتهاك بشكل قانوني.

لا تدعى هذه الملابس الوقائية من الأمراض المعدية أو تمنع أي مرض أو تقلل بالضرورة العدوى.

الدرع  
SHIELD

by  
SANTHOME

من  
سانثوم

هيك  
فيرو بلاك  
للحماية من الفيروسات  
والبكتيريا  
VIROBLOCK  
ANTIVIRAL PROTECTION

ANTIVIRAL ANTIBACTERIAL

تتميز بوزن خفيف، تلتصق بملابسك  
The silver ions are trapped in the textile matrix.

منع تراكم البكتيريا أو الفيروسات؛ لأنها  
تسبح نحو فتحة على الثياب وتبقى ميتة  
When bacteria or viruses are present, they are unable to replicate and therefore die.

تكون رطوبتك الجفوة  
تجف بسرعة، رائحة الملابس  
تكون منعشة ورائحة الثياب  
Without the presence of bacteria, the moisture in the fabric and body dries faster.



Tagless label



WNEN 165 - XANTHI

Cotton jumping rope with wooden handle in a cotton pouch

Print Technique : SC

Preferred Print Location : Pouch

Max Print Size : 110 x 150 mm

READY STOCK



Skipping Rope



Stretch Band



Exercise all muscles incl Cardio

Value-driven fitness gift

HR distribution to employee

GSWN 521 - WALTROP

Set of skipping rope & stretch band in pouch

Print Technique : SC

Preferred Print Location : Pouch

Max Print Size : 50 x 110 mm



GSWN 522 - DASSEL

Set of Skipping Rope & Resistance band in pouch

Print Technique : SC

Preferred Print Location : Pouch

Max Print Size : 50 x 150 mm





- 183 x 61 cm Size , 0.5 cm Thick
- Cork is a renewable material
- Stay fit, Stay healthy
- Employees (HR) gift



**WNEN 166 - ARCALIS**

Cork Yoga mat - high end feel. TPE used in base material.

Print Technique : SC,HT

Preferred Print Location : Pouch

Max Print Size: 200 X 50 mm

Product Size : 183 X 61 X 0.5 cm

Packing Details : 47 X 35 X 63.5 cm ; 12 pcs / carton ; gw / nw : 10.8/11.8 kgs / carton



**Hans Larsen™**  
Drinkware



**DWHL 216 - SWEL**

Hans Larsen™ Swel is a 400ml protein shaker with Three compartments, first /top for liquid, second for vitamins, and third for protein powder. Made from BPA free materials and is leakproof. Carabiner allows easy clipping onto your belt loop or backpack.

Print Technique : SC

Preferred Print Location : Front

Max Print Size : (Flat) 40 x60 mm

Product Size : 21.8 x ø9.5 cm

Packing Details : 53 x 53 x 33 cm; 50 pcs/carton; gw/nw: 11 kg/carton



soft & stretchy



**SPORT BAND**



**GMMK 150 - FREDERICKSBURG**

Sports sweat band made from stretchy & soft sweat absorbing materials.

Print Technique : HT

Preferred Print Location : Front

Max Print Size : 40 x 50 mm

Product Size : 0.7 x 260 cm

Packing Details : 35 x 36.5 x 60 cm ; 1000 pcs / carton ; gw / nw : 13 kg / carton

READY STOCK



Giftology



- > 100% Free Of Chemicals
- > UV Protection
- > Fast Cooling When Needed
- > In Easy To Bring Bottle With Carabiner

READY STOCK



WNGL 167 - LEBUS

Giftology Lebus is a Microfibre cooling towel 100% free of chemicals. 98% sun blocking function up to UV 50+ protection. The towel can be easily used by adding some cold water to the bottle creating a cool towel for fast refreshment. The bottle is made out of PP with ABS top and carabiner to take along on outdoor activities. Registered design®

Print Technique : UV, SC, EMBROIDERY Preferred Print Location : Bottle  
Max Print Size : 190 x 45 mm Product Size : 17.5 x 7x 6 cm (Bottle)  
Packing Details : 74 X 40 X 40 cm; 100 pcs/carton; gw/nw: 16 kg/carton

## SANTHOME



BPSN 916 - SHOBAC

SANTHOME Shobac is a 18"laptop backpack for the modern man who wants to work hard during the day and perform sports or go the gym in his leisure time. This backpack has 2 main compartments, a side mesh pocket, an air mesh back and high quality jaquard lining. Be active, Be smart!

Print Technique : SC, ENG Preferred Print Location : Front Flap  
Max Print Size : 140 x 50 mm Product Size : 45 x 30 x 14.5 cm  
Packing Details : 49x 38 x 58 cm ; 10 pcs / carton ; gw / nw ; 13 kg / carton

Sweatproof Waterproof Waist Pouch  
Spandex Material



Sensitive Touch Screen

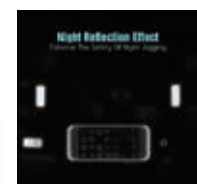

Black



Grey



WNWB 201 - Black WNWB 202 - Grey

WBSIN Slim and lightweight waist pouch for your smartphone and for other useful things needed during sports activities. It has an adjustable belt, reflective tape around the zipper, an output for headphones and touch frontal part for devices. It is suitable for smartphones up to 5".

Print Technique : SC Preferred Print Location : Front Left  
Max Print Size : 20 x 35 mm Product Size : 27.5 x 9.5 x 1.5 cm  
Packing Details : 108.5 X 26 X 31.5 cm; 100 pcs/carton; gw/nw: 11kg/carton

# RECYCLED COTTON DUFFEL BAGS/ SUNGLASSES



**300 GSM  
Sturdy Fabric**

**This Bag Saved**

**-10,000  
Litres**

**Water**



- > Outside Zipper pocket for quick access & safety
- > Easy to wash-&-clean



**DBEN 430 - PUEBLA**

Eco neutral GRS-Certified Recycled Cotton Duffel Bag in Natural color - Least / almost NIL Impact on environment

Print Technique : SC

Preferred Print Location : Front Pocket

Max Print Size : 180 x 160 mm

Product Size : 49 x ø26 cm

**READY STOCK**



**SGMK 101 - ISKAR**

Sunglasses with UV400 protection of classic design. Matte finish frame with black lenses.

Print Technique : SC

Preferred Print Location : Right & Left Frame

Max Print Size : 40 X 6 mm

Packing Details : 40 X 22 X 77 cm ; 300 pcs / carton ; gw / nw : 8 kg / carton



**PRILEP**

**SGEN 101 - Blue SGEN 102 - Green**

**eco-neutral** Sunglasses with frame made out of wheat straw fibre. Packed in kraft paper box. With UV 400 glasses.

Print Technique : Sc Preferred Print Location : Side

Max Print Size : 50 x 5mm Product Box Size : 3 X 5.5 X 14.5 cm

Packing Details : 65 X 29.5 X 41 cm ; 200 pcs / carton ; gw / nw : 10 kg / carton

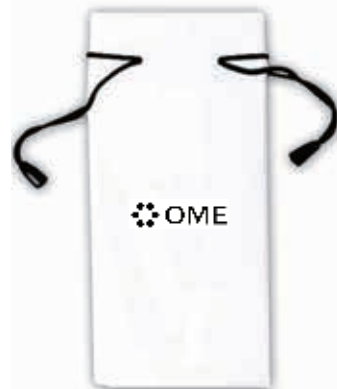

**GPMK 101 - MADAN**

Polyester Eyewear cleaning cloth cover in soft polyester with self-closing laces.

Print Technique : SC

Preferred Print Location : Center

Max Print Size : 100 X 50 mm

Product Size : 9 X 18 cm

Packing Details : 26 X 23 X 55 cm ; 1000 pcs / carton ; gw / nw : 8 kg / carton



READY STOCK



Black

- Exquisite scent of Arabian Oud
- 30 burning hours
- Frosted glass candle with bamboo lid



White

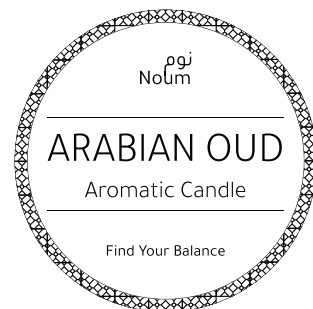

NOUM

SCEN 9101 - Black SCEN 9102 - White

eco-neutral Enjoy tranquility, peace and balance with the NoUm aromatic / scented candle. With the fragrance of Arabian Oud, the scented candle comes in an elegant frosted glass jar with bamboo lid. Lasts 30 hours. Packed in a kraft gift box

Print Technique : UV, SC, ENG Preferred Print Location : Lid Max Print Size : ø83 mm

Product Size : 11 x ø8.5 cm



LUXURY



- > Fitness Smart Watch With-Heart Rate Monitor
- > Full Touch Screen-Advanced Chipset
- > Includes Magnetic Wireless Charger
- > Compatible with iOS 9.0, Android 5.0 and above

READY STOCK



Heart rate monitor



Includes Wireless Charging



Syncs with your mobile



Smart voice calling



Bluetooth music playback



Sleep Monitoring



Weather Display



Yoga guide - Mindfulness



Multi Sport Mode



Heart Rate



Long Battery Life (7 - 15 days)



Pedometer



Sleep Monitoring



Notifications



1.54" Full Touch Screen



Connected GPS



Blood Pressure



Sedentary Reminder



Incoming Call Alert



Music Control



Find My Phone



Stopwatch

WNAT 1130 - THONEX

©MEMORI Live your best life with the Thonex smart watch. Thonex pairs with your smartphone through Bluetooth and comes packed with a range of features: voice calling, social media notifications, voice assistant, music playback, contacts, dialing, alarm, etc. as well as health and fitness features such as pedometer, heart rate monitor, blood oxygen, sleep monitor, etc. Made using a solid zinc alloy casing, and removable silicone straps. Battery life: 7-15 days. Includes a magnetic wireless charger.

Print Technique : ENG, UV

Preferred Print Location : Strap

Max Print Size : 30 x 10 mm

# THE GOLF LINE

## Includes



SANTHOMÉ

*Golf • Legacy*



READY STOCK

- Complete line of golf accessories golfers use on and around the green
- All products are patented
- Rated as Best Divot Repair tool Golf Digest 2018
- Multiple awards in innovation
- Used by Europe Ryder Cup Team

- High Quality Range for Clubs' Shops, Members' Memorabilia, Event Sponsorship Gifts
- Includes Gift Sets, Bag Tags, Divot Tools, Towels, Tees, Gloves, Balls, Groove Tools, Polos, Caps, Shoe Bags, Pouches
- Quality Branding with Consistency

*Truly the best ball mark fixer I've ever used*

Chip Beck





Pitchfix Retail Displays



**GAPF 582**  
PAR 2.0 Display  
Pitchfix Display for Tools and Ballmarker



**GAPF 583**  
BIRDIE 2.0 Tools & Hat Clips  
Pitchfix Display for Tools,  
Ball marker and Hat clips.



**GAPF 584**  
BIRDIE 2.0 Display  
with added 16 tools module

**READY STOCK**



### Pitchfix Original 2.0

WITH PITCHFIX<sup>®</sup> LOGO



Watch Product Video

- Switchblade function, 4 colours
- High-quality ABS handles
- Lightweight, aluminium sheets
- Removable logo ball marker



GAPF 561WL  
Black

GAPF 562WL  
Blue

GAPF 563WL  
Red

GAPF 564WL  
Green



Tin Box Available on request  
GAPF 581

READY STOCK

### Pitchfix XL 3.0

WITH PITCHFIX<sup>®</sup> LOGO



Watch Product Video



GAPF 566WL  
Blue

GAPF 568WL  
Green

GAPF 565WL  
Black

GAPF 567WL  
Red

- Switchblade function, 3 colours
- Soft Touch handles
- Lightweight, aluminium sheets
- Removable logo ball marker
- Integrated pencil sharpener

Tin Box Available on request  
GAPF 581



GAPF 572WL  
Black

GAPF 573WL  
Blue

GAPF 574WL  
Pink

### Pitchfix Hybrid 2.0

WITH PITCHFIX<sup>®</sup> LOGO



Watch Product Video







## Pitchfix Fusion 2.5 Pin

WITH PITCHFIX<sup>®</sup> LOGO

- > ABS rubberized handles
- > Available in 3 colours
- > Colored aluminium trims
- > Pencil sharpener
- > Removable 1" ball marker

Tin Box Available on request  
GAPF 581



GAPF 569WL  
Black



GAPF 570WL  
Blue



GAPF 571WL  
Pink



Watch Product Video

## Pitchfix Round Tin Tool & 2 Extra Ball Markers

WITH PITCH FIX LOGO

Our metal round turns Pitchfix into a high quality gift item.

- Set contains
- 1 x Pitchfix Original 2.0
  - 2 x Ball marker
  - 1 x Premium Gift Tin Box



GAPF579WL - TROMSO  
Black



GAPF 586WL - TROMSO  
Blue



GAPF 587WL - TROMSO  
Red

## Pitchfix Round Tin Tool, Hat Clip & 2 Extra Ball Markers

WITH PITCH FIX LOGO

Our metal round tin turns Pitchfix into a high quality gift item.

Available colours Black, Blue, Pink.

- Contents:
- 1 Pitch fix Original 2.0
  - 1 Ball marker (GAPF 585)
  - 1 Hat Clip (choice of hatclip)
  - 1 x Branded Premium Gift Tin Box (GAPF 580)



GAPF 580 WL  
Black

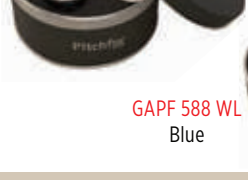

GAPF 588 WL  
Blue



GAPF 589 WL  
Pink

READY STOCK



GAPF 576 WL  
Black



GAPF 577WL  
Blue



GAPF 578 WL  
Pink

## Pitchfix Hat Clip 25mm

WITH PITCH FIX LOGO

- > Available in 3 colours
- > Stainless Steel
- > Light weight
- > Removable logo ball marker



Watch Product Video



# CORPORATE

Golf Gifts from Pitchfix



READY STOCK



www.pitchfixUSA.com

4

## GREAT PERFORMANCE.

Performance matters when in the middle of a golf course, no one carries 'spares'. Our tools are proven to deliver excellent reliability and performance to be a positive reflection of our brand and also yours!



*All our tools are designed to include a customized ball marker to feature your own name, logo or crest*



## GREAT BRANDING.

All of our products can be branded, in full colour, with your club, society or corporate logo. Our hard resin doming production ensures your design remains crystal clear for years.



*WE CAN EVEN OFFER TOOLS  
PERSONALISED WITH THE RECIPIENTS  
NAME ON REQUEST -*

*CONTACT OUR TEAM FOR DETAILS!*

## JUST GREAT!



### GREAT COLOURS

Our complete product range is available in wide variety of colours to ensure your logo will stand out from the crowd.

### GREAT PACKAGING

The perceived value of a gift is always increased with professional packaging. Whether supplied as a pre-event invitation, a 1st tee gift, table reward, locker room award, membership or sales incentive, our high quality steel alloy presentation packaging elevates your branded items to a memorable and valuable gift.

### GREAT CHOICE

We have a flexible range of tools and packaging options to suit every budget or event. Our team will work with you to make the right selections for your needs.

### GREAT VALUE

Investing in high quality promotional gifts is a proven method to ensure your marketing budget reaches its maximum potential. By placing your logo on the best golf accessories in the business, any golfer will know and associate your brand with the highest quality.

The value of a constant reminder of your brand in your recipients hand, in the form of a useful and desirable product is a marketing asset that can continue to deliver exposure and goodwill time and time again.



READY STOCK



### Pitchfix Original 2.0

YOUR LOGO EPOXY DOMING 1 POSITION PER ITEM

- Switchblade function
- 4 colours: Blue, Black, Green, Red
- High-quality ABS handles
- Lightweight, aluminium sheets
- Removable logo ball marker



Tin Box Available on request  
GAPF 581



### Pitchfix Hybrid 2.0

YOUR LOGO EPOXY DOMING 1 POSITION PER ITEM

- ABS rubberized handles
- 3 colours: Blue, Black, Pink
- Colored aluminium trims
- Pencil sharpener
- Removable 1" ball marker



READY STOCK

### PitchfixFusion 2.5 Pin

YOUR LOGO EPOXY DOMING 1 POSITION PER ITEM

- ABS rubberized handles
- 3 colours: Blue, Black, Pink
- Colored aluminium trims
- Pencil sharpener
- Removable 1" ball marker



### Pitchfix XL 3.0

YOUR LOGO EPOXY DOMING 2 POSITIONS PER ITEM

- Switchblade function
- 4 colours: Blue, Black, Green, Red
- High-quality ABS handles
- Lightweight, aluminium sheets
- Removable logo ball marker





## Pitchfix Hat Clip 25mm

YOUR LOGO EPOXY DOMING 1 POSITION PER ITEM

- Available in Blue, Black & Pink
- Stainless Steel
- Light weight
- Removable logo ball marker



## Pitchfix Round Tin Tool & 2 Extra Ball Markers

YOUR LOGO EPOXY DOMING 1 POSITION PER ITEM

Our metal round turns Pitchfix into a high quality gift item. Set contains

- 1 x Pitchfix Original 2.0
- 2 x Ball marker
- 1 x Premium Gift Tin

READY STOCK



## Pitchfix Round Tin Tool, Hat Clip & 2 Extra Ball Markers

YOUR LOGO EPOXY DOMING 1 POSITION PER ITEM

Our metal round tin turns Pitchfix into a high quality gift item. Available colours Black & Blue.

Contents:

- 1 x Branded Pitch fix Original 2.0 (choice of divot tool)
- 1 x Branded Ball marker (GAPF 585)
- 1 x Branded Hat Clip (choice of hatclip)
- 1 x Branded Premium Gift Tin (GAPF 580)**





# SANTHOME GOLF LEGACY & OTHER GOLF ACCESSORIES



READY STOCK



**GADT 235 - BRUGG** - Divot tool with a ball marker in a tin gift box  
Print Technique : EPOXY  
Print Location : Top of Box Max Print Size : 24 x 55 mm  
Print Location : Ball Marker Max Print Size : ø20 mm



**GALT 236 - KARAK** - Metal luggage tag with leather strap in a tin gift box  
Print Technique : EPOXY  
Print Location : Front of Tag Max Print Size : ø55 mm  
Print Location : Top of Box Max Print Size : 24 x 55 mm



> Ideal for Golf events, memberships & Loyalty, Souvenirs & gifting.

**GSGA 233 - BIASCA**

Elegant metal gift box with high quality Divot Tool (with Ball marker) & Bag Tag.

Print Technique: EPOXY Preferred Print Location : Top of Box, On Tag, On Ball Marker

READY STOCK



> Ideal for Golf events, memberships & Loyalty, Souvenirs & gifting.

**GSGA 234 - ASCONA**

Elegant metal gift box with high quality Divot Tool (with Ball marker) & 2 Golf Balls.

Print Technique : EPOXY for Top of Box and on Ball Marker  
: PAD PRINTING for balls



# GOLF TEES / GOLF BALLS GROOVE TOOL



**GATE 237** - KRANJI - Set of 30 wooden 7cm golf tees in a tin gift box  
Print Technique : EPOXY Preferred Print Location : On Box Max Print Size : 24 x 55 mm

READY STOCK



**ODDER**  
**GAGB 975** - GOLF BALLS  
2 layer Golf balls. Set of 3 Golf balls in customised paper packaging



**RONNE**  
**GAMT 976** - GROOVE TOOL  
Plastic groove cleaner with an extendable brush, spike, wire brush and with carabiner.





Grey



Pink



LUXURY POUCH  
PACKAGING ON REQUEST

MARABA

GATW 978 - Grey GATW 992 - Pink

Print Technique : EMBROIDERY

Preferred Print Location : Front

Max Print Size : 90 x 70 mm

# SANTHOME

SANTHOME Deluxe pique mesh spandex fitted cap



White/White sandwich



Navy blue/White sandwich



Red/Black sandwich



Black/White sandwich

- One Size Fits All
- Excellent Shape Retention Even After Multiple Uses
- Contrast Color Sandwich On Front
- Fabric With Pores For Air Ventilation

SC 105

Santhome Nu-Fit® Performance Caps are a premium quality 6-panel constructed pique mesh spandex fitted cap, utilizing the patented Stretch-Fitting technology from Nu-Fit®. Stretch fitting by Nu-Fit® has excellent shape retention even after multiple uses and one size fits all. The pique mesh knit provides air ventilation, and spandex provides sweat absorption. Contains contrast sandwich. Santhome Nu-Fit® Performance Caps are an excellent premium cap / sports cap / outdoors / baseball cap.

Print Technique : HT, Embroidery Preferred Print Location : Front / Back Max Print Size: 45 x 35 mm

Packing Details : 62x 36 x 56 cms ; 150 pcs /carton ; gw/nw: 16.5 kg / carton

READY STOCK



# ORCA<sup>[i]</sup> MERCERIZED GOLF POLO SHIRTS

Colours in Ready Stock\*



Cobra  
(Khaki/Black)



Midnight Sky  
(Navy/Khaki)

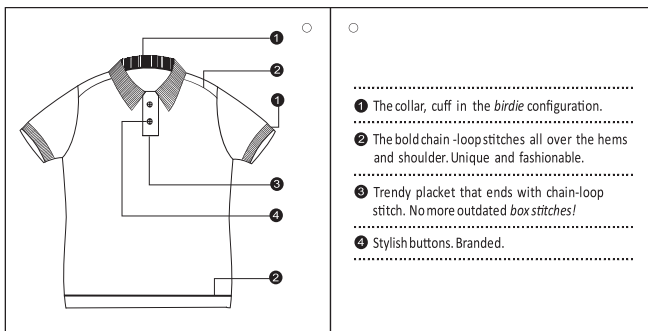

READY STOCK

"ORCA is found in Antarctica and Arctic oceans. Also called ' Killer Whales', it is the largest of the Dolphin family. They are beautiful, intelligent, fast, strong and yet the most social of all sea animals! They are said to have great tolerance in varying temperatures. That is the reason they enjoy world-wide distribution. Most interestingly, it's the only species in the world that has both the male and the female offspring stay with their mothers and immediate family forever...!"



These wonderful creatures have inspired us to bring to you exclusive polos. Their 'killer look', beauty, sheen and lustre is attributed to the MERCERIZING process. The premium cotton rich material makes it extremely comfortable in all climatic conditions. The collar, cuff in the birdie configuration sets new standards in their making. The bold loop stitches all over the hems and shoulder make them unique and yet resilient. Finally just as the ORCA, this polo will stay with you for long time to come.

Shouldn't then it be called the ORCA POLO?"

Item : ORCA | Content : Premium Cotton rich MERCERIZED fabric  
Measurement : Gulf | Sizes Available : S, M, L, XL, XXL, 3XL

### Print Technique :

- 1 Screen Print
- 2 Heat Transfer
- 3 Embroidery

Preferred Print Location : Max Print Size:

Left Chest Area / Sleeve 80 x 50 mm



### Care Instructions:

#### Packing:



56 x 36x 40 cm ; 50 pcs /carton ; gw/nw: 15.7kg / carton

\* Packing details may have +10% variation based on size breakup



Unique bold loop stitching at end of placket

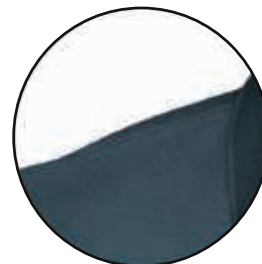

Unique bold loop stitching on shoulder & all hems



Unique birdie configuration collar/cuff



Thick side embossed button

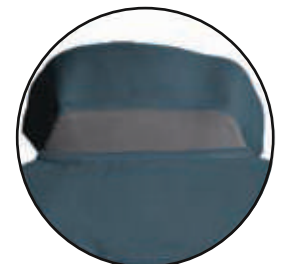

Trendy 'Picaso' collar

\* Printing Limitations prevent exact fabric and color representation. The shades in the lots may differ due to lot-to-lot variations. The difference is no more than internationally accepted norms of the garment trade.

[i] Orca is manufactured under license from SANTHOME HOLDINGS LTD. (BVI).

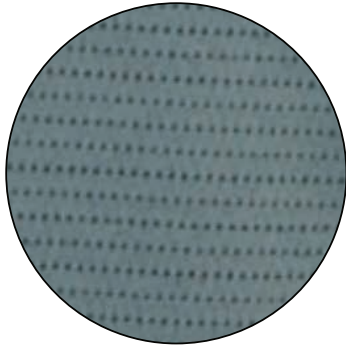

Special textured 2-tone knit fabric



Dark Grey



White

- Swing+ Tech swing support mechanism
- Enhanced stretch for better range of motion
- UV protection against harmful UV sunlight
- Moisture wicking DryNcool® fabric
- Lightweight fabric

**READY STOCK**

**سانديز اند بت**  
من  
**سانتوم**  
غولف • ليجاسي

حماية من الأشعة فوق البنفسجية  
ابق متعشاً

**Sandies & Putt**  
by  
**SANTHOME**  
Golf • Legacy

UV Protected  
Stay Fresh

\* تحتوي اشعة الشمس على الأشعة فوق البنفسجية الضارة ، و التي تسبب في حروق الشمس و جفاف البشرة مع هذا القميص الخاص من بولايو يتم استخدام تكنولوجيا تعمل على منع حروق الشمس، الأضرار المزمنة التي تحدث للبشرة حتى تتكيف من الامتصاص للشمس في املاء.

\* يستخدم تقنية (نظام معالجة الرطوبة) ، يقوم هذا السبيج بطرد الرطوبة بعيداً عن البشرة الى سطح السبيج حيث يتبخر سريعاً مما يحافظ على جفاف و راحة جسمك .

\* باتيكم هذا السبيج المصنع بتقنية نظام معالجة الرطوبة في تصاميم مميزة و يعمل بطريقة ممتازة على التهوية بالسبيج مما يجعله أكثر راحة.

**معالجة الرطوبة**  
MMS  
نظام

**Evaporation**  
Moisture  
Skin

\* Sun rays contain harmful UV rays which causes sunburn and damage to skin. This special polo uses a technology that prevents sunburn, long term skin damage and you can enjoy sun safely.

\* Using MMS (Moisture Management System) technology, this fabric pulls out the moisture away from the skin to the surface of the fabric for quick evaporation, which keeps your body dry and comfortable.

\* This PERFORMANCE fabric with MMS in the special Knit Design works as excellent Ventilation for free breathing of fabrics, making it more comfortable.

**Evaporation**  
Moisture  
Skin

**MMS**  
MOISTURE MANAGEMENT SYSTEM

\*Santhome & Dryncool are registered trademarks of Santhome Holding Limited (BVI). Any infringement and duplication attempt will be dealt with legally.

Item : SNP  
Content : 100% polyester, Special Knit  
Measurement : Gulf Sizes Available : S, M, L, XL, XXL, 3XL  
Print Technique :  
① Screen Printing ② Heat Transfer ③ Embroidery  
Preferred Print Location : Left Chest Area / Sleeve  
Max Print Size: 80 x 50 mm



LEATHER GLOVE



GAGV 987 - TIDORE - Golf Gloves, Left - Medium/Large Size    GAGV 988 - TIDORE - Golf Gloves, Left - Large Size  
GAGV 989 - TIDORE - Golf Gloves, Right - Medium/Large Size    GAGV 990 - TIDORE - Golf Gloves, Right - Large Size

READY STOCK

PU GLOVE



GAGV 981 - OSASCO - Golf Gloves, Left - Medium Size    GAGV 993 - OSASCO - Golf Gloves, Left - Large Size  
GAGV 994 - OSASCO - Golf Gloves, Right - Medium Size    GAGV 995 - OSASCO - Golf Gloves, Right - Large Size



**PRAVETS**  
**GASN 175 - GOLF SHOE BAG**  
 A compact golf shoe bag with 2 sides pocket for golf accessories.  
 Print Technique : SC Preferred Print Location : Front Max Print Size : 100 x 250 mm

READY STOCK



**LUXURY POUCH -**

Create your own bundle of Golf Gifts & package them in this Luxury Pouch

**GAPB 984 - ROHAN**  
 Print Technique : SC Preferred Print Location : Front Max Print Size : 19 x 25 mm

# THE END OF GREENWASHING

Greenwashing refers to false sustainability claims - a growing problem for the modern conscious buyer

We believe true sustainability starts with **TRANSPARENCY & TRACEABILITY**

Our new **CHANGE** collection aims to end greenwashing and lead our industry in a new direction



With every purchase of CHANGE collection products, **a donation is made to Water.org**, a non-profit that provides access to safe water and sanitation. They have helped **over 36 million** people access safe water to date!

**CHANGE.**  
SERIOUS SUSTAINABILITY

*CHANGE Collection is about design, serious sustainability and giving back.*

*All recycled fabrics are certified by the Global Recycled Standard.*

*Gifts that give water: 3% of sale proceeds from this collection is committed by brand owners to Water.org to save lives with safe water*

## OUR IMPACT APRIL 2021 - MARCH 2022



Total Savings



**63,311,594**

LITRES OF WATER SAVED



**251,065**

PLASTIC BOTTLES RE-PURPOSED



**1,752**

PEOPLE PROVIDED WITH LASTING SAFE WATER OR SANITATION THROUGH WATER.ORG



READY STOCK



## GIFTS THAT GIVE BACK

- 785 million people - 1 in 9 - lack access to safe water. We are supporting Water.org to change this.
- For each CHANGE bottle sold, **3% of sales is donated** by the brand owners to Water.org to save lives with safe water and sanitation.



- > 3% of sales proceeds of each product committed to Water.org
- > 8 hours hot, 24 hours cold
- > Sustainable water bottle and packaging
- > Elegant silicone loop for easy carrying
- > 600ml capacity
- > Scandinavian design

NEBRA

DWHL 516 - Black DWHL 517 - White DWHL 518 - Grey DWHL 519 - Navy Blue

Hans Larsen® Hans Larsen® Nebra Vacuum Insulated Water Bottle is part of the CHANGE Collection, and as a result, contributes to Water.org - a global NGO that provides millions with access to safe water and sanitation. By giving to Water.org, you are giving a GIFT THAT GIVES BACK. Nebra is double walled, leakproof, has a carry loop, stainless steel reusable water bottle with 8 hours hot, and 24 hours cold storage. Scandinavian design. Content: 600ml. Packed in a stylish recycled box that educates about making the Change from single-use to reusable products.

Print Technique : DM

Print Technique : UV, SC, ENG

Product size : ø7.5 X 23 cm

Preferred Print Location : Top of Lid

Preferred Print Location : Front

Packing Details : 51.5 x 32 x 26 cm ; 24 pcs /carton ; gw/nw : 9 kg / carton

Max Print Size : ø50 mm

Max Print Size : (Flat) 140 x 25 mm (Round) 140 x 230 mm



READY STOCK



## STAINLESS STEEL MUG WITH BAMBOO LID

QUALITY

- > 3% of sales proceeds of each product committed to Water.org
- > 15 hours cold, 5 hours hot
- > A Designer Mug that supports Sustainable living
- > Double-Walled
- > SS 304 Inside, SS 201 Outside

### GIFTS THAT GIVE BACK

- 💧 785 million people - 1 in 9 - lack access to safe water. We are supporting Water.org to change this.
- 💧 For each CHANGE mug sold, **3% of sales is donated** by the brand owners to Water.org to save lives with safe water and sanitation.



LAREN

DWHL 334 - White DWHL 333 - Black DWHL 336 - Green DWHL 335 - Blue DWHL 341 - Grey DWHL 342 - Aqua Green

Hans Larsen™ Inspired by Scandinavia, Laren is created for the discerning connoisseur who loves the best. 3% of the sale proceeds go to water.org to change someone's life.

Print Technique : ENG, UV, SC  
Product Size : ø8.5 x 11 cm

Preferred Print Location : Front of Mug & Lid of Mug

Max Print Size : (Front of Mug) 50 x 25 mm (Lid of Mug) ø 80 mm

Packing Details : 55.5 X 28.5 X 27cms ; 36 pcs / carton ; gw / nw : 10.6 / 8.6 kg / carton





Blue

Grey

White

Green

Aqua Green



Black

READY STOCK

## STAINLESS STEEL BOTTLE WITH BAMBOO LID

### QUALITY

- > Double-Walled water bottle
- > SS 304 Inside, SS 201 Outside
- > 560 ml Capacity
- > Vibrant Colors
- > High quality
- > 3% of sales proceeds of each product committed to Water.org
- > 24 hours cold, 8 hours hot

### GIFTS THAT GIVE BACK

- 💧 785 million people - 1 in 9 - lack access to safe water. We are supporting Water.org to change this.
- 💧 For each CHANGE bottle sold, **3% of sales is donated** by the brand owners to Water.org to save lives with safe water and sanitation.



BREDA

DWHL 337 - Black DWHL 338 - White DWHL 339 - Grey DWHL 340 - Blue DWHL 343 - Green DWHL 344 - Aqua Green

Hans Larsen™ Breda is part of Hans Larsen CHANGE. Collection. Proudly use this bottle knowing that you have made a Change in someone's life through our contribution to water.org.

Print Technique : ENG, UV, SC  
Product Size: ø7 x 24.5 cm

Preferred Print Location : Front & Top      Max Print Size : (Front) 120 x 25 mm (Top) ø 40 mm  
Packing Details : 39.5 X 39.5 X 28.5 cms ; 25 pcs / carton ; gw / nw : 9.5 / 7.5 kg / carton



QUALITY



READY STOCK

## STAINLESS STEEL TUMBLER WITH METAL STRAW

- > 3% of sales proceeds of each product committed to Water.org
- > 15 hours cold, 5 hours hot
- > High-end Tumbler with flexible straw
- > Straw Cleaner in high quality stainless steel included
- > 540 ml Capacity
- > Double-Walled
- > SS 304 Inside, SS 201 Outside

### GIFTS THAT GIVE BACK

- 💧 785 million people - 1 in 9 - lack access to safe water. We are supporting Water.org to change this.
- 💧 For each CHANGE tumbler sold, **3% of sales is donated** by the brand owners to Water.org to save lives with safe water and sanitation.



BORCULO

DWHL 331 - Black DWHL 332 - White

**Hans Larsen™** Borculo Vacuum Insulated Tumbler with Reusable Straw is part of the CHANGE Collection, and as a result, contributes to Water.org - a global NGO that provides millions with access to safe water and sanitation. By giving to Water.org, you are giving a GIFT THAT GIVES BACK. Borculo is double walled, leakproof, stainless steel reusable coffee tumbler with 5 hours hot, and 15 hours cold storage. Scandinavian design. Includes a reusable straw with a straw cleaner. Content: 540ml. Packed in a stylish recycled box that educates about making the Change from single-use to reusable products.

Print Technique : ENG, UV, SC  
Product Size: ø8 x 17 cm

Preferred Print Location : (Colored Front) (Steel Front) Max Print Size : (Colored Front) 100 x 25 mm (Steel Front) 30 x 25 mm  
Packing Details : 57 X 34 X 25 cms ; 30 pcs / carton ; gw / nw : 10.9 / 8.6 kg / carton



- > Stainless Steel Water Bottle
- > SS 304 Inside, SS 201 Outside
- > Double Walled Vacuum
- > 24 Hours Cold & 8 Hours Hot
- > Leak Proof
- > Screw-On Cap; BPA Free
- > 500 ml Capacity

READY STOCK



Black

White



HUNFELD

DWHL 280 - Black DWHL 281 - White

Hans Larsen™ CHANGE Double Walled Stainless Steel Vacuum Water Bottle (500ml). This bottle makes an impact by supporting Water.org to provide safe water to people in need with every purchase. Packed in an elegant recycled gift box.

Print Technique : UV, SC, ENG

Preferred Print Location : Front

Max Print Size : 110 X 20 mm

Product size : ø 6.8 x 26 cm

Packing Details : 45 x 30.5 x 28.4 cm ; 24 pcs /carton ; gw/nw: 6.5/8 kg/ carton

### GIFTS THAT GIVE BACK

785 million people - 1 in 9 - lack access to safe water. We are supporting Water.org to change this.

For each CHANGE bottle sold, **3% of sales is donated** by the brand owners to Water.org to save lives with safe water and sanitation.



1 Ocean bottle = 1000 Ocean - Bound Plastic Bottles Collected



SMALL BOTTLE  
**BIG  
IMPACT**



By 2050, plastic  
in the oceans will  
outweigh fish



"Ocean bottle is the  
first tangible ocean  
impact we have"

London  
**Evening  
Standard**

"If Apple designed  
a drinks container for  
life, this would be it."

  
**THE TIMES**

"Fighting plastic  
pollution at a  
grassroots level"

**Forbes**



ORACLE  
Red Bull RACING

WHY OCEAN BOTTLE?

• Oracle Red Bull Racing utilised Ocean Bottle to create a world leading plastic Corporate Social Responsibility programme in line with their carbon reduction and offset schemes



COMPANY GIFTING



24,000,000 PLASTIC BOTTLES COLLECTED



23,936 OCEAN BOTTLES PURCHASED



272,000 KGS OF OCEAN PLASTIC COLLECTED

webexone

WHY OCEAN BOTTLE?

- Used Ocean Bottle Plastic Collection Certificates in Annual Report
- Used the Bottles as a communications tool to tell their Employees about the impact they created
- Shared OB's Welcome Pack with each recipient



COMPANY GIFTING



7,125,000 PLASTIC BOTTLES COLLECTED



7,125 OCEAN BOTTLES PURCHASED



81,225 KGS OF OCEAN PLASTIC COLLECTED



WHY OCEAN BOTTLE?

Mercedes-Benz Global HQ bought 4100 Ocean Bottles for giveaways at their corporate events, such as their Golf Events & their track driving days for **prospective clients**

Events Include:

- Ladies Business Cup
- AWGC Tour
- Mercedes Trophy Golf
- Mercedes-AMG Track days



COMPANY GIFTING



4,100,000 PLASTIC BOTTLES COLLECTED



4,100 OCEAN BOTTLES PURCHASED



46,740 KGS OF OCEAN PLASTIC COLLECTED





# Corporate's Certificate (example)

**CERTIFICATE OF SOCIAL PLASTIC COLLECTION**

PROUDLY AWARDED TO  
**EXAMPLE COMPANY**



FOR PREVENTING  
**46,609 KGS**

FROM ENTERING OUR OCEAN.

POWERED BY IMB BLOCKCHAIN+



ISO 17033 Ethical Claims Verified  
26000 Social Responsibility Verified  
SEDEX Compliant

IMPACT CERTIFICATE

READY STOCK

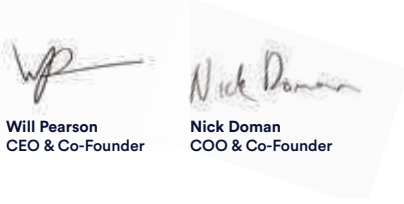

January 2021  
[www.oceanbottle.co](http://www.oceanbottle.co)  
@oceanbottle

## SUSTAINABLE FROM THE START

- Our packaging is **FSC certified, recycled** and **recyclable**
- **Designed to ship** without the need for useless plastic sleeves
- Interactive packaging that tells the brand and product mission.
- Customisable





# OUR HERO PRODUCT & AWARDS

Made from **insulated stainless steel** and **recycled ocean bound plastic**.

Designed in Norway by award winning **K8 Industridesign**, developing the bottle from user insight all the way to our **award winning** final product.



# MORE THAN JUST A BOTTLE

## Value add benefits

- Each Ocean Bottle funds the collection of **1000 ocean-bound plastic bottles** in weight & improves social mobility
- Receive **collector** stories and **content**
- Company plastic collection **impact certificate**
- **Co-founder talks** or panel for your audience
- **PR support** with messaging and communications
- **Branding opportunity** on merchandise
- Each Ocean Bottle is entirely **carbon neutral**, offsetting **4.88kg of carbon** (per unit sold)



1 FOR 1000 // 1 FOR 1000 // 1 FOR 1000 // 1 FOR 1000 // 1 FOR 1000 // 1 FOR 1000 // 1 FOR 1000 //

# SOCIAL IMPACT

We work with individuals all over the world, wherever plastic pollution is worst, to stop the flow at its source.

Collectors exchange plastic for **money** and get access to **social resources** such as **healthcare, education, mental health support** and **financial security**

All enabled by our network of plastic collection partners.





# SERIOUSLY SUSTAINABLE DRINKWARE

500 ML

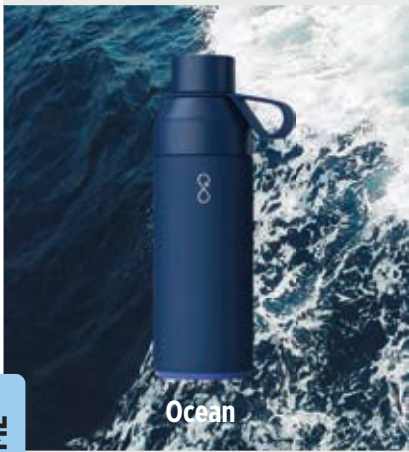

Ocean



Rock



Forest



Sky

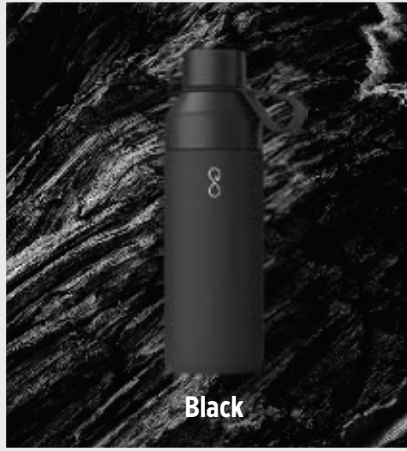

Black



Sun

READY STOCK

Scan Below QR code to watch product video



BESPOKE EXAMPLE



- > Reusable bottle that funds the collection of 1000 plastic bottles in weight
- > Dishwasher safe
- > 180° twist anti-leak lid with dual opening for drinking and easy cleaning
- > Vacuum stainless steel insulation keeping hot things hot and cold things cold
- > Ice, coffee, tea, juice, smoothies, still and sparkling water — it's all good

## OCEAN BOTTLE

DWOB 291 - Black DWOB 292 - Ocean DWOB 293 - Sun DWOB 294 - Sky DWOB 295 - Forest DWOB 296 - Rock

Our original award-winning 500ml Ocean Bottle keeps cold drinks cold, and hot drinks hot. Made from double wall vacuum-insulated stainless steel and recycled content. The anti-leak dual opening lid makes filling and cleaning a breeze. Plus, unlike most reusable bottles, Ocean Bottle is 100% dishwasher safe.

Available in six colours: Ocean Blue, Rock Grey, Sun Orange, Forest Green, Obsidian Black and Sky Blue.

Print Technique : SC, UV, ENG Preferred Print Location : Front Max Print Size : 120 X 25 mm

Product Size : 22 X ø 6.8 cm Packing Details : 49 X 34 X 27 cm ; 24 pcs / carton ; gw / nw : 10 kg / carton





1000 ML



Black



Ocean



Rock

Meet BOB.

# THIRSTY FOR MORE?

Scan Below QR code to watch product video

READY STOCK

EACH BOB FUNDS THE COLLECTION OF 1,000 PLASTIC BOTTLES, 11.4KGS OF PLASTIC

**1 LITRE**

- Hot and Cold stainless steel vacuum insulation up to 18 hours
- No sweat exterior
- Recycled ocean-bound plastic base
- NFC Smart Chip Enabled to collect more plastic with every refill
- Dual opening for easy fill, clean and ice
- Dishwasher Safe BPA free
- Anti-leak seal 180 twist cap
- Easy carry loop
- Drinking Cup

Meet BOB.

The award-winning Ocean Bottle just a lot bigger. Because bigger is better when it comes to hydration. BOB is perfect for the car, on your desk or for a family sharing.

1 Big Ocean Bottle collects 1000 plastic bottles and improves livelihoods in coastal communities.

BIG OCEAN BOTTLE

DWOB 297 - Black DWOB 298 - Rock DWOB 299 - Ocean

Our award-winning 1000ml Big Ocean Bottle keeps cold drinks cold, and hot drinks hot. Made from double wall vacuum-insulated stainless steel and recycled content. The anti-leak dual opening lid makes filling and cleaning a breeze. Plus, unlike most reusable bottles, Big Ocean Bottle is 100% dishwasher safe. Available in three colours: Ocean Blue, Rock Grey and Obsidian Black.

Print Technique : SC, UV, ENG Preferred Print Location : Front Max Print Size: 175 X 30 mm  
 Product Size : 26.4 X ø 8.5 cm



## SERIOUSLY SUSTAINABLE FLASK

EACH BREW FLASK FUNDS THE **COLLECTION OF 1,000 PLASTIC BOTTLES, 11.4KGS OF PLASTIC.**

**EASY SWAP LID** - If you have an Ocean Bottle you can swap the Brew lid with the Original to suit different needs and occasions

**KEEPS STUFF HOT** - Thermal lid and double-insulation keep drinks how you like them up to 6 hours

**TWIST TO LOCK LID** - The simple 180 twist lid mechanic means you can seamlessly lock the lid or unlock it

**360 LID LETS DRINKS FLOW** - Feels like drinking from your favourite cup and lets the coffee flow and circulate

**NFC ENABLED** - So you can collect more plastic every time you refill

**LEAK PROOF** - Leak-free lid and sweat-free surface keep wet stuff safely on the inside

**LASTS A LIFETIME** - designed for durability, recyclable 'til the end



READY STOCK



Coffee on the go never tasted so good.

Brew is designed to be the only drink companion you need when you're on the **go**.

With a **360° lid**, it feels like you're drinking from your favourite cup, and let's the coffee flow and aromas circulate.

Our brew flasks are made from **99%** recycled stainless steel double wall vacuum-insulated recycled materials, won't leak or sweat in your bag and are **100%** dishwasher safe – all while helping to **save the ocean, every Brew funds the collection of 1000 plastic bottles.**





Sun



Sky



Forest



Ocean



Rock



Black



Scan QR code to watch product video



READY STOCK

**A HOT / COLD BEVERAGE CONTAINER FROM THE OCEAN BOTTLE FAMILY**

- > Reusable Mug that funds the collection of 1000 plastic bottles in weight
- > Dishwasher safe
- > 360° twist anti-leak lid with for ultimate drinking convenience
- > Vacuum stainless steel insulation keeping hot things hot and cold things cold

BREW

DWOB 3121 - Black DWOB 3122 - Ocean DWOB 3123 - Sun DWOB 3124 - Sky DWOB 3125 - Forest DWOB 3126 - Rock

The new 350ml Ocean Bottle-BREW keeps cold drinks cold, and hot drinks hot. Made from double wall vacuum-insulated stainless steel and recycled content. The anti-leak dual opening lid makes filling and cleaning a breeze. Plus, unlike most reusable Flasks/Mugs, Ocean Bottle is 100% dishwasher safe.

Available in six colours: Ocean Blue, Rock Grey, Sun Orange, Forest Green, Obsidian Black and Sky Blue.

Print Technique : SC, UV, ENG Preferred Print Location : Front Max Print Size : 115 X 25 mm

Product Size : 17 X ø6.8 cm



# STAINLESS STEEL SOFT TOUCH WATER BOTTLES



750 ml



Black

White

Aqua Blue

TAUNUS

DWGL 3101 - Black DWGL 3102 - White DWGL 3103 - Aqua Blue

Giftology Double Walled Vacuum Insulated Stainless Steel Water Bottle with elegant soft touch coating. Leakproof lid. 5 hours hot / 15 hours cold. Capacity: 750ml

Print Technique : UV, SC, ENG

Preferred Print Location : Front

Max Print Size : (Flat) 175 X 25 mm; (Round) 175 X 245 mm

Product Size : 27.2 x ø7.8 cm

READY STOCK



1000 ml



Black

White

GRIGNY

DWGL 3113 - Black DWGL 3114 - White

Giftology Double Walled Vacuum Insulated Stainless Steel Water Bottle with elegant soft touch coating. Leakproof lid. Capacity: 1000ml

Print Technique : UV, SC, ENG

Preferred Print Location : Front

Max Print Size : (Flat) 30 X 205 mm; (Round) 260 X 205 mm

Product Size : 29.5 X ø8.3 cm



READY STOCK



- > Dual copper and vacuum insulation
- > 12 hours hot, 20 hours cold
- > Comes in 8 vibrant corporate colors
- > 500 ml capacity

**Leak Proof Lid**



**COPPER VACUUM INSULATION**  
Copper plated inner wall for longer hours of enjoyment

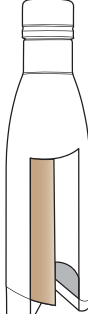

☺  
12H

❄  
20H

NIESKY

DWGL 541 - Black DWHL 542 - White DWHL 543 - Navy Blue DWHL 544 - Aqua Blue DWHL 545 - Titanium DWHL 546 - Red  
DWHL 547 - Purple DWHL 547 - Green

Giftology Double wall stainless steel with copper insulating vacuum bottle. Capacity 500 ml. Leak free. Perfect to keep your favourite drink hot for 12 hours or cold for 20 hours, wherever you go. Available in 8 vibrant colors

Print Technique : UV, SC, ENG

Preferred Print Location : Front

Max Print Size : (Flat) 30 x 90 mm; (Round) 220 x 90 mm

Product size : 26.7 X ø7.1 cm



# DOUBLE WALL STAINLESS STEEL WATER BOTTLE

Hans Larsen™



Black



White

- > Vacuum insulated with unique 100% gloss coating
- > 6 hours hot, 12 hours cold
- > 500ml capacity



SONTRA

DWHL 346 - Black DWHL 347 - White

*Hans Larsen* Sontra by Hans Larsen® is a double walled classic stainless steel water bottle with a unique 100% glossy coating for a unique look and feel. The bottle keeps chilled beverages cold for up to 12 hours and hot drinks warm for up to 6 hours. This bottle will keep you hydrated on the go wherever you are. Capacity 500ml, leakproof, SS 304 inside SS 201 outside. Packed in a gift box.

Print Technique : SC, UV, ENG  
Product size : 26.7 X ø7 cm

Preferred Print Location : Front  
Packing Details : 46 x 32 x 29 cm ; 24 pcs /carton ; gw/nw: 7.6 kg / carton

Max Print Size : 30 x 110 mm

READY STOCK



- > This bottle is suited for round full color sublimation printing
- > Vacuum insulated with unique 100% gloss coating
- > 500ml capacity

SUBLIMATION



DWHL 348 - GERA

*Hans Larsen* The classic vacuum insulated stainless steel water bottle with a unique 100% glossy coating + possibility of all-around sublimation printing. The bottle keeps chilled beverages cold for up to 12 hours and hot drinks warm for up to 6 hours. This bottle will keep you hydrated on the go wherever you are. Capacity 500ml, Leakproof, SS 304 inside SS 201 outside. Packed in a gift box

Print Technique : SUBLIMATION  
Product size : 26.7 X ø7 cm

Preferred Print Location : Front  
Packing Details : 47 x 32 x 29 cm ; 24 pcs /carton ; gw/nw: 7.6 kg / carton

Max Print Size : (Round Sublimation) 110 x 220 mm



Stay Hydrated On-The-Go



READY STOCK



Black



- ▶ Vacuum Insulated S.S. bottle
- ▶ Cold for 10 hours, Hot for 5 hours 500 ml Capacity
- ▶ Double Walled Leakproof
- ▶ SS 304 inside SS 201 outside
- ▶ Elegant Soft Touch



Navy Blue



Grey



White



Green

GRODNO

DWGL 365 - Black DWGL 366 - White DWGL 367 - Grey DWGL 368 - Navy Blue DWGL 369 - Green

Rubberized solid colour vacuum insulated stainless steel bottle. The bottle keeps chilled beverages cold for up to 10 hours and hot drinks warm for up to 5 hours. This bottle will keep you hydrated on the go wherever you are. Capacity 500ml, Leakproof, SS 304 inside SS 201 outside

Print Technique : UV, SC, ENG

Preferred Print Location : Front

Max Print Size : 30 x 70mm

Product Size : 26 x ø7 cm

Packing Details : 77.5 X 40 X 30 cms ; 50 pcs / carton ; gw / nw : 17/14 kgs / carton



# DOUBLE WALL STAINLESS STEEL WATER BOTTLE

Giftology



Black

- Vacuum Insulated
- SS 304 Inside
- SS 201 Outside
- Elegant Soft-touch Exterior



White

1000 ml

VALENCE

DWGL 3111 - Black DWGL 3112 - White

Giftology Double Walled Vacuum Insulated Stainless Steel Water Bottle with elegant soft touch coating. Leakproof lid. Capacity: 1000ml - Large.

Print Technique : UV, SC, ENG

Preferred Print Location : Front

Max Print Size : (Flat) 160 X 30 mm; (Round) 160 X 283 mm

Product Size : 32.7 x ø9 cm

READY STOCK



Hans Larsen™

- Stunning all over wood prints on bottle
- 5 hours hot, 15 hours cold
- 500ml capacity



Light Wood Print

500 ml



Dark Wood Print

GEYER

DWHL 408 - Dark Wood Print DWHL 409 - Light Wood Print

Hans Larsen™ This sleek looking leakproof vacuum insulated stainless steel water bottle will keep you hydrated on the go wherever you are. The all over wood print on the body makes the bottle a real eye catcher. The bottle keeps chilled beverages cold for up to 15 hours and hot drinks warm for up to 5 hours. Capacity 500ml. BPA free.

Print Technique : ENG

Preferred Print Location : Front

Max Print Size : (Flat) 25 X 130 mm; (Round) 220 X 130 mm

Product Size : 26.7 x ø7cm

Packing Details : 41 x 41 x 30.5 cm; 25 pcs /carton; gw/nw: 9.5/7.5 kg / carton





READY STOCK



450 ml

- > SS 304 Inside, SS 201 Outside
- > Easy Grip, Flat Sides
- > Wide Mouth Fits Ice Cube
- > 12 Hours Cold And 8 Hours Hot
- > Screw-On Cap; BPA Free



GALATI

DWHL 401 - Black   DWHL 402 - White   DWHL 403 - Copper   DWHL 404 - Grey   DWHL 406 - Blue

Hans Larsen™ Galati is the only Stainless Steel reusable water bottle that you will ever need. This water bottle keeps liquids cold for up to 12 hours and hot for upto 8 hours without any sweating on the exterior; plus, a wide-mouth opening allows ice to easily go in and flat-sides offers a secure grip for every sip. Capacity: 450 ml

Print Technique : UV, SC, ENG

Preferred Print Location : Front

Max Print Size : 30 x 120mm

Product Size : 24 x ø7 cm

Packing Details : 54 X 48 X 28 cms ; 30 pcs / carton ; gw / nw : 12 kg / carton



- > 650ml Stainless Steel Bottle
- > Unique Lid With Drink Reminder
- > Leak Proof



DWXD 817 - AQUA

XDDDESIGN Track your daily hydration goals with this smart designed stainless steel 650ml. water bottle. The lid displays a bigger water drop each time you refill and twist the collar so you can easily keep count of the number of bottles you drink. Handwash only and leakproof. Registered design®

Print Technique : UV, SC, ENG Preferred Print Location : Front  
Max Print Size : (Flat) 30 x 100 mm (Round) 200 x 100 mm Product Size : 20.9 x ø7 cm  
Packing Details : 26.5 x 31 x 46 cm ; 24pc /carton; gw/nw: 5.76 kg / carton

READY STOCK



### NEVA STAINLESS STEEL WATER BOTTLE



500 ml



DWXD 614 - NEVA

XDDDESIGN Neva is an alternative in the battle against disposable plastic water bottles. Thanks to the 500 ml body made in durable 304 stainless steel, Neva can be your everyday bottle. The fabric strap allows you to carry the bottle while also serving as a quick release for the leak proof spout. Registered design®

Print Technique : ENG, SC, UV Preferred Print Location : Center Max Print Size : (Flat) 25 x 80 mm, 180 x 120 ( Round )  
Product Size : 22 x ø6.2 cm Packing Details : 26 x 47 x 61 cm ; 48pcs /carton ; gw/nw : 10.9 kg / carton



Black



Designed by:



Ryan McSorley  
Ireland



reddot design  
award winner



UI 1270 - BOPP MINI

XDDDESIGN Bopp Mini is a compact 350ml bottle with a matt body and with attached carabiner that makes it easy to clip onto your bag, belt or other gear you take with you. Registered design®

Print Technique : UV, SC, ENG Print Location : Front Down  
Max Print Size : (Flat) 25 x 90 mm (Round) 180 x 50 mm  
Product Size : 18.0 x ø6.4 cm  
Packing Details : 48 x 37x 43 cm ; 60 pcs /carton ; gw/nw: 12 kg / carton



Blue





- > Made from borosilicate glass to hold hot and cold liquids
- > Glass decanter with cork lid
- > Contemporary design
- > 600ml capacity



600 ml



DWEN 362 - BERKA

**eco-neutral** Borosilicate glass bottle with a cork lid. Store your fresh made juices, water or other drinks in this glass bottle. Because it is made from borosilicate glass, it can also hold hot liquids. The cork lid gives the decanter a natural look. Capacity: 600 ml.  
 Print Technique : UV, SC Preferred Print Location : Front  
 Max Print Size : (Flat) 150 X 25 mm (Round) 223 X 150 mm  
 Product Size : 23 x ø7.1 cm



- > Made from borosilicate glass to hold hot and cold liquids
- > Glass decanter with cork lid
- > Contemporary design
- > 1000ml capacity

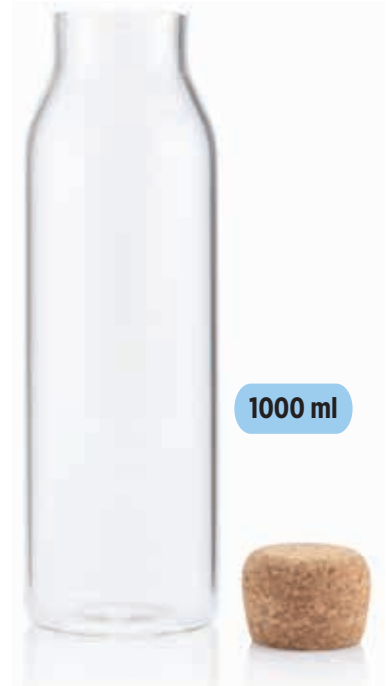

1000 ml



DWEN 363 - DELLACH

**eco-neutral** Borosilicate glass bottle with a cork lid. Store your fresh made juices, water or other drinks in this glass bottle. Because it is made from borosilicate glass, it can also hold hot liquids. The cork lid gives the decanter a natural look. Capacity: 1L.  
 Print Technique : UV, SC Preferred Print Location : Front  
 Max Print Size : (Flat) 190 X 30 mm (Round) 267 X 190 mm  
 Product Size : 29.4 x ø8.5 cm

READY STOCK



# ECO FRIENDLY GLASS WATER BOTTLES

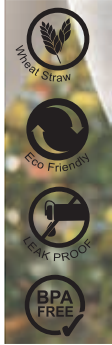

- Glass Inside
- ECO Wheat Straw Exterior
- Phone Stand
- 380 ml Bottle with carry handle



Mobile Stand

DWGL 361 - RABI

**eco-neutral** Eco Friendly water bottle with glass interior and wheat straw exterior. With convenient handle for easy carrying and a phone stand at the base. Capacity 380ml. BPA free. Packed in a gift box.

Print Technique : UV, SC, ENG  
Product Size : 21 x ø6.3cm

Preferred Print Location : Front    Max Print Size : (Flat)30 X 100 mm; (Round) 100 X 190 mm  
Packing Details : 56 x 35.5 x 23.5 cm; 40 pcs /carton; gw/nw: 13/12 kg / carton

READY STOCK



GRUENE

DWMK 101 - White

420ml capacity glass bottle with protective neoprene sleeve in bright tones. With screw-on safety cap and carrying belt.

Print Technique : SC, UV    Preferred Print Location : All over  
Max Print Size : 60 x 50 mm    Product Size : 19 x ø6.4 cm  
Packing Details : 40 x 37 x 37cms; 50pc /carton; gw/nw: 14 kg / carton



Hans Larsen™



- Made From Borosilicate Glass
- 500 ml; Heat Resistant
- Sleeve Included For Drop Protection



DWHL 351 - BRASOV

**Hans Larsen™** Time to purify your lifestyle, and change the way you drink water. Glass is 100% recyclable and doesn't contains harmful chemicals or unwanted flavours into your water like plastic or metal. Brasov water bottle is reusable and is entirely BPA free, lead free and worry free. Made from high borosilicate glass, which is more heat resistant than any other commonly used glass. With fashionable sleeve for drop protection and heat insulation. Content 500 ml.

Print Technique : SC, UV    Preferred Print Location : Bottle  
Max Print Size : (Flat) 25 x 120 mm, (Round) 70 x 120 mm    Product Size : 21.6x ø6.7 cm  
Packing Details : 49 x 33 x 26.5 cm; 24pc /carton; gw/nw: 11 kg / carton



500 ml

READY STOCK

- Borosilicate glass bottle with carry handle
- Sleeve added for safety and extra insulation
- 500ml capacity
- Eco Bamboo Top



FLOHA

DWHL 352 - Black DWHL 353 - White DWHL 354 - Jute DWHL 355 - Royal Blue DWHL 356 - Green

Hans Larsen Floha is a borosilicate glass bottle with a bamboo lid + handle, with a color sleeve. Capacity: 500ml

(Bottle) Print Technique : UV, SC, ENG

Preferred Print Location : On Top

Max Print Size : ø54 mm

(Sleeve) Print Technique : UV, SC

Preferred Print Location : On Sleeve

Max Print Size : (Flat) 155 x 20 mm

Product Size : 24 x ø7.1 cm



Hans Larsen™  
Premium Drinkware



Made from natural fast growing bamboo and 100% recyclable borosilicate glass, this reusable bottle is designed to support the environment.

READY STOCK



- > Borosilicate Glass Body & Eco Bamboo Top Cap
- > Silicon Sleeve For Protection
- > Eco-Friendly !!



DWHL 502 - MEGARA

Hans Larsen™ Megara is made from glass that is 100% recyclable and that doesn't infuse harmful chemicals or unwanted flavours into your water like plastic or metal and eco-friendly bamboo lid. Made from high grade borosilicate glass, which is more heat resistant than any other commonly used glass. Now you can save the planet and enjoy your warm tea too. With fashionable silicone sleeve for drop protection and heat insulation. Content 550ml.

Print Technique : UV, SC, ENG

Preferred Print Location : Top Max Print Size : 45 x 40 mm

Product Size : 24 x ø6.8 cm

Packing Details : 49 X 33 X 26 cm; 24 pcs/carton; gw/nw: 14.5 kg/carton



READY STOCK



- Unique dual lid mechanism
- Inbuilt straw and lid options
- 1L capacity with sturdy carry handle
- Premium powder coated finish

1000 ml

DWHL 3105 - USLAR

*Hans Larsen*™ The ultimate stainless steel bottle for on-the-go versatility. The lid has a dual function that has both a flip top straw and screw cap so you can choose how you want to drink from the bottle! The bottles features a large top handle for easy carrying. Double wall vacuum insulated stainless steel keeps beverages hot for up to 5 hours or cold for up to 15 hours. A powder coat finish creates a highly durable and premium exterior. Capacity 1000ml. BPA free.

Print Technique : UV, SC, ENG  
Product Size : 27.2 x 11 x 9.8 cm

Preferred Print Location : Front      Max Print Size : (SC) 90 X 100 mm (ENG & UV) 26 X 100 mm



# BIO BOTTLES MADE IN THE NETHERLANDS

# Tacx

BIO BOTTLES MADE IN THE NETHERLANDS

**Tacx** Are you looking for a bottle fully made of biodegradable materials? Then the Bio-Bottle of Tacx is a great choice. It stands out because the plastic of the bottle is biodegradable. Adding a small amount of bio-material changes the molecular structure so the material finally breaks up in biogas and biomass. This feeds the soil and it's completely absorbed by nature. The process of disintegration starts when the bottle ends up at a microbiological environment (compost heap, waste disposal).



**WB 003**  
Transparent / Aqua Lid  
750CC



**WB 003**  
Silver - 750CC



**WB 003**  
Transparent /  
Red Lid 750CC



**WB 003**  
Transparent /  
Purple Lid 750CC



**WB 003**  
Transparent /  
Blue Lid 750CC



**WB 003**  
Transparent /  
Pink Lid 750CC



**WB 003**  
Transparent /  
Grey Lid 750CC



**WB 003**  
Transparent /  
Royal Blue Lid 750CC

## Made in THE NETHERLANDS

- Bio Degradable
- 100% Recyclable
- Safe for Food Use
- Screw-On Cap With A Leak Proof Spout
- Secure Grip On Triangular Cap For Easy - Opening And Closing Of Bottle
- Certified Bio-Degradable Water Bottles.
- FDA Approved For Contact With Food.
- OSHA Approved As Non-Hazardous.
- Indefinite Shelf Life.

READY STOCK

## Stocks Available



**WB 002**  
Full Red  
500CC



**WB 002**  
Full White  
500CC



**WB 002**  
White/  
Blue Lid  
500CC

Print Technique : UV, SC Preferred Print Location : Center  
Max Print Size : (Flat) 33 x 50 mm, 230 x 50 mm ( Round )  
Product Size 500CC : ø7.7 x 19.6 cm  
Packing Details : 38 x 38 x 39 cm ; 50 pcs /carton ; gw/nw: 4.40 kg / carton



Print Technique : UV, SC  
Product Size 750CC: ø7.7 x 25 cm

Preferred Print Location : Center Max Print Size : (Flat) 33 x 100 mm, 230 x 100 mm ( Round )  
Packing Details : 39 x 39 x 52 cm ; 50 pcs /carton ; gw/nw: 5.5 kg / carton





Hans Larsen™  
Drinkware



- TRITAN™ Body
- 800ml ; Leak Proof
- Single Hand Operation

DWHL 506 – BATUMI

*Hans Larsen* Trendy infuser bottle to flavour your water with your favourite fruit or herbs. The body is made out of TRITAN™ material so it is scratch proof and durable. The lid is made out of ABS and is leakproof so you can take your flavoured water wherever you go. Capacity 800 ml.

Print Technique : UV, SC Preferred Print Location : Front  
Max Print Size : (Round) 33 x 160 mm (Flat) 220 x 150 mm  
Product Size : 27.9 x ø7.6 cm  
Packing Details : 47 x 32 x 59.5 cm ; 50pc/carton; gw/nw: 14 kg / carton

**Tacx**

BIO BOTTLES MADE IN THE NETHERLANDS



- Food Approved, Free Of BPA And Phthalates
- Dishwasher Safe
- Recyclable Plastic
- 20% Post Industrial Recycled Plastics
- All Caps Are Fitted With Lockable Pull Lids
- Easy To Squeeze; Made From Soft Plastics
- Large Opening, Easy To Clean
- Dutch Design

READY STOCK



FUSE

DWTX 501 - Black DWTX 502 - Light Blue DWTX 503 - Dark Blue DWTX 504 - Red

**Tacx** The Fuse bottle is a squeezable elegant life style bottle with a fruit fusion stick. Add taste and vitamins to your water by threading pieces of fruit or herbs onto the fruit fusion stick. The bottle holds 450cc, is made from soft squeezable BPA free polyethylene and has a pull lid for easy drinking. A carry on handle helps carry it around for various sports activities.

Print Technique : UV, SC Preferred Print Location : Front  
Max Print Size : 198 x 147 mm (Round) Product Size : 23 x ø6.4 cm  
Packing Details : 32.5 x 32.5 x 46.3 cm ; 50 pcs /carton ; gw/nw: 9.78 kg / carton



# DRINKWARE



Unique Lid Displays Amount Of Water Consumed & Re-filled For Easy Tracking



- 600ml Tritan Bottle
- Unique Lid With Drink Reminder
- Leak Proof



DWXD 827 - AQUA TRITAN

XDDESIGN® Track your daily hydration goals with this cleverly designed 600 ml tritan water bottle. The lid displays a bigger water drop each time you refill and twist the collar so you can easily keep count of the number of bottles you drink. Handwash only & Leakproof.

Print Technique : UV, SC, DOM Preferred Print Location : Front  
Max Print Size : (Flat) 25 x 80 mm (Round) 200 x 100 mm Product Size : 23 x ø7 cm  
Packing Details : 26 x 32 x 47 cm ; 24pc /carton; gw/nw: 4.9 kg / carton

## XDDESIGN®



## XDDESIGN®



- 600ml Lockable Tritan Bottle
- Leak Proof
- Single Handed Operation



HYDRATE BOTTLE

DWXD 910- Transparent / Anthracite

XD×CLUSIVE™ Leak proof lockable tritan bottle with handle. Content: 600ml. Registered design®

Print Technique : UV, SC, Preferred Print Location : Front  
Max Print Size : (Flat) 25 x 80 mm (Round) 200 x 100 mm Product Size : 23.4 x 7.2 cm  
Packing Details : 27 x 26 x 59 cm ; 21pc /carton; gw/nw: 4.25 kg / carton

READY STOCK

## Giftology



680 ml



DWGL 303 - AACHEN

Giftology 680ml water bottle with fruit infuser compartment. Infuse your water with fresh fruits and additional flavours into the infuser compartment. The infuser compartment can also be used to chill your water by adding ice cubes. Also prepares your detox water and enjoy the infusion.

## Hans Larsen™ Drinkware



DWHL 216 - SWEL

Hans Larsen™ Swel is a 400ml protein shaker with Three compartments, first /top for liquid, second for vitamins, and third for protein powder. Made from BPA free materials and is leakproof. Carabiner allows easy clipping onto your belt loop or backpack.

Print Technique : SC Preferred Print Location : Front  
Max Print Size : (Flat) 40 x 60 mm Product Size : 21.8 x ø9.5 cm  
Packing Details : 53 x 53 x 33 cm ; 50 pcs/carton; gw/nw: 11 kg/carton



XDXCLUSIVE® | ECO+

**Squared Lockable Leak Proof Tritan Water Bottle**



XDXCLUSIVE® | ECO+

**Honeycomb Lockable Leak Proof Infuser Bottle**



Transparent

Blue

Black

Locking Mechanism



Black

White

READY STOCK



- ▶ Single Handed Operation
- ▶ 600 ml Leak Proof Bottle
- ▶ Locking Mechanism
- ▶ Silicone Border / Sleeve
- ▶ Tritan Bottle; BPA Free



- ▶ Single Hand Operation
- ▶ 700 ml Leak Proof Bottle
- ▶ BPA Free ; Tritan material
- ▶ Locking Mechanism
- ▶ Infuser



HONEYCOMB  
 DWXD 901 - Black    DWXD 902 - White

**SQUARED**  
 DWXD 904 - Black    DWXD 905 - Transparent    DWXD 906 - Blue  
 XDXCLUSIVE® This unique shaped water bottle with silicone sleeved body allows convenient single-handed drinking. Push the button and the lid flips open. There's a special locking mechanism to keep users away from accidentally pressing the button. This water bottle is made of a durable and innovative tritan material. Odourless and 100% BPA-free. Content 600ml. Registered design®  
 Print Technique : SC, UV                      Preferred Print Location : All Sides  
 Max Print Size : 40 x 50 mm                  Product Size : 20.7 x 8.8 x 5 cm  
 Packing Details : 24 x 35 x 41.5 cm ; 24pc /carton ; gw/nw: 4.5 kg / carton

XDXCLUSIVE® Add some healthy fruit flavours to your water. This designer bottle with honeycomb details offers convenient single-handed drinking. Push the button and the lid flips open. There's a special locking mechanism to keep users away from accidentally pressing the button. Including carrying handle. This infuser bottle is made of a durable and innovative tritan material. Odourless and 100% BPA-free. Content 700ml. Registered design®  
 Print Technique : SC, UV                      Preferred Print Location : Side  
 Max Print Size : 30 x 40 mm                  Product Size : 24.8 x ø8.6 cm  
 Packing Details : 28 x 36.5 x 53.5 cm ; 24pc /carton ; gw/nw: 5.5 kg / carton



# VACUUM FLASKS & TUMBLER

SWISS PEAK®



- > Copper Vacuum Construction
- > Powder Coated Finish
- > Double Wall 18/8 Grade Steel
- > Leak Proof
- > 8 Hrs Hot, 24 Hrs Cold

DWSW 102 - ELITE COPPER VACUUM FLASK, 0.5 L

**SWISS PEAK®** The Swiss Peak Elite series are with vacuum insulation and double wall 18/8 grade stainless steel. The powder coated black colour is built to last! No fading or cracking here! The inner wall is plated with copper for ultimate conductivity to keep drinks hot for 8 hours and cold for 24 hours. Hand washable and leakproof. Content 500 ml.

Print Technique : UV, SC, ENG  
Product Size : 25.5 X ø7.4 cm

Preferred Print Location : Front

Max Print Size : 30 X 110 mm

Packing Details : 55 x 27 x 34.5 cm ; 24 pcs / carton ; gw / nw : 13kg / carton

READY STOCK

XDDESIGN®



300 ml

- > Trendy Geometric Design
- > Durable 201 Stainless Steel

DWXD 719 - MOSA TUMBLER

**XDDESIGN®** Mosa is a fashionable 300ml tumbler from durable 201 stainless steel with an inside PP lining. Registered design®

Print Technique : UV, SC, ENG

Preferred Print Location : Front Bottom

Max Print Size : (Flat) 25 x 50 mm (Round) 200 x 50 mm

Product Size : 15.5 x ø7 cm

Packing Details : 53 x 42 x 36 cm ; 60 pcs/carton ; gw/nw: 13.35 kg / carton

XDDESIGN®



500 ml



- > Trendy Geometric Design
- > Durable 201 Stainless Steel

DWXD 820 - MOSA FLASK

**XDDESIGN®** Mosa is a fashionable 500ml double wall vacuum flask in durable 201 stainless steel. The flask closes with a PP lid that can be used to enjoy your hot beverages. Registered design®

Print Technique : UV, SC, ENG

Preferred Print Location : Front Bottom

Max Print Size : (Flat) 25 x 80 mm (Round) 200 x 80 mm

Product Size : 23.5 x ø6.9 cm

Packing Details : 28.0 x 41.0 x 53.0 cm ; 30 pc ; 6pcs/carton ; gw/nw: 12.7 kg / carton



- > 500 ml Capacity
- > Top Part For Engraving Logo
- > Food Grade



Stainless Steel Vacuum Flask

DWHL 259 - EGALÉO

Double walled Flask with capacity 500ml (gross), 470ml (net). Material - Stainless steel (SS 304 inner, SS 201 outer). Keeps drinks hot for 8 hours, cold for 12 hours. Food Grade

Print Technique : SC, UV, ENG

Preferred Print Location : Front & Top

Max Print Size : (Front) 60 x 50 mm (Top) ø45 mm

Product Size : ø6.5 x 22.5 cm

Packing Details : 73 X 37 X 25 cm ; 50 pcs / carton ; gw / nw : 15/14 kgs / carton



Black

480 ml



White

Tall mug with ECO Cork base

RASTATT

DWGL 3107 - Black DWGL 3108 - White

Giftology Double Walled Vacuum Insulated Stainless Steel Travel Coffee Mug with cork base. Capacity: 480ml

Print Technique : UV, SC, ENG

Preferred Print Location : Front

Max Print Size : (Flat) 140 X 25 mm; (Round) 140 X 250 mm

Product Size : 17.5 x ø8 cm

READY STOCK



Black

500 ml



Steel

Convenient carry handle

ECO Cork base

500 ml capacity

CREIL

DWGL 3109 - Black DWGL 3110 - Steel

Giftology Double Walled Vacuum Insulated Stainless Steel Water Bottle with carry handle and cork base. Capacity: 500ml

Print Technique : UV, SC, ENG

Preferred Print Location : Front

Max Print Size : (Flat) 140 X 30 mm; (Round) 140 X 220 mm

Product Size : 27.5 x ø7 cm



# TEMPERATURE DISPLAY STAINLESS STEEL FLASK

READY STOCK



White



Silver



Navy Blue



Black



- Inside Temperature Display on lid
- Popular Design
- SS 304 Stainless Steel inside
- Food Grade
- 8 hours hot, 12 hours cold

500 ml



KOVEL

DWGL 3116 - Black DWGL 3117 - White DWGL 3118 - Silver DWGL 3119 - Navy Blue

Giftology Double Walled Vacuum Insulated Temperature Display Stainless Steel Flask with 8 hours hot and 12 hours cold. The temperature indicator on the lid displays the current temperature of the liquids inside. Capacity: 500ml

Print Technique : UV, SC, ENG

Preferred Print Location : Front

Max Print Size : (Flat) 190 X 25 mm; (Round) 190 X 204 mm

Product Size : 23.7 x ø6.5 cm

# ANTIMICROBIAL COFFEE TUMBLER



Black

White

Blue

- Classic universal design
- Contains Biomaster lifetime antimicrobial
- Insulated 250ml mug



READY STOCK



## CELLE

DW XD 731 - Black DW XD 732 - White DW XD 733 - Blue

This simplistic designed stainless steel tumbler is not only aesthetically beautiful but is also protected with Biomaster, an Anti-Microbial agent that provides a second line of defence against harmful bacteria. The body and lid are both treated and it's IN the product, not ON the product which will give you permanent protection. This product is tested in accordance with ISO 22196 for Anti-Microbial effectiveness. Biomaster does not affect the recyclability of the item. The product also includes Verimaster a unique tracer that is built into the material to prove that the item is treated with Biomaster. With closable lid. PP inner, stainless steel outer. Capacity 250ml. BPA free.

Print Technique : UV, SC, ENG  
Product Size : 10.5 x 9.2 x 8.5 cm

Preferred Print Location : Front Max Print Size : (UV & ENG) 2.5 x 7 cm (SC) 8 x 5 cm  
Packing Details : 60 x 40 x 15 cm; 24 pcs/carton; gw/nw: 4.3 kg/carton



## SERIOUSLY SUSTAINABLE FLASK

EACH BREW FLASK FUNDS THE **COLLECTION OF 1,000 PLASTIC BOTTLES, 11.4KGS OF PLASTIC.**

**EASY SWAP LID** - If you have an Ocean Bottle you can swap the Brew lid with the Original to suit different needs and occasions

**KEEPS STUFF HOT** - Thermal lid and double-insulation keep drinks how you like them up to 6 hours

**TWIST TO LOCK LID** - The simple 180 twist lid mechanic means you can seamlessly lock the lid or unlock it

**360 LID LETS DRINKS FLOW** - Feels like drinking from your favourite cup and lets the coffee flow and circulate

**NFC ENABLED** - So you can collect more plastic every time you refill

**LEAK PROOF** - Leak-free lid and sweat-free surface keep wet stuff safely on the inside

**LASTS A LIFETIME** - designed for durability, recyclable 'til the end



READY STOCK



Coffee on the go never tasted so good.

Brew is designed to be the only drink companion you need when you're on the **go**.

With a **360° lid**, it feels like you're drinking from your favourite cup, and let's the coffee flow and aromas circulate.

Our brew flasks are made from **99%** recycled stainless steel double wall vacuum-insulated recycled materials, won't leak or sweat in your bag and are **100%** dishwasher safe – all while helping to **save the ocean, every Brew funds the collection of 1000 plastic bottles.**



Social Enterprise UK  
Certified Member

ocean  
bottle





Sun



Sky



Forest



Ocean



Rock



Black



Scan QR code to watch product video



**A HOT / COLD BEVERAGE CONTAINER FROM THE OCEAN BOTTLE FAMILY**

- > Reusable Mug that funds the collection of 1000 plastic bottles in weight
- > Dishwasher safe
- > 360° twist anti-leak lid with for ultimate drinking convenience
- > Vacuum stainless steel insulation keeping hot things hot and cold things cold

READY STOCK

BREW

DWOB 3121 - Black DWOB 3122 - Ocean DWOB 3123 - Sun DWOB 3124 - Sky DWOB 3125 - Forest DWOB 3126 - Rock

The new 350ml Ocean Bottle-BREW keeps cold drinks cold, and hot drinks hot. Made from double wall vacuum-insulated stainless steel and recycled content.

The anti-leak dual opening lid makes filling and cleaning a breeze. Plus, unlike most reusable Flasks/Mugs, Ocean Bottle is 100% dishwasher safe.

Available in six colours: Ocean Blue, Rock Grey, Sun Orange, Forest Green, Obsidian Black and Sky Blue.

Print Technique : SC, UV, ENG Preferred Print Location : Front Max Print Size : 115 X 25 mm

Product Size : 17 X ø6.8 cm



# ECO & DESIGNER MUGS

**Hans Larsen™**  
Premium Drinkware

Black



- Double Wall Stainless Steel Tumbler / Mug
- Designed To Fit Coffee Machines
- Hot: 5 Hrs. Cold: 15 Hrs

White



Grey



GOUDA

DWHL 508 - Black DWHL 510 - White DWHL 511 - Grey

Hans Larsen™ Vacuum insulated cork coffee mug with unique cork detail 304 SS inside and 201SS outside. Keeps your drinks hot for up to 5h and cold up to 15h. Fits most coffee machines. Content: 180ml.

Print Technique : UV, SC, ENG

Preferred Print Location : Front

Max Print Size : 30 X 60 mm (Flat) 200 X 50 mm (Round)

Product Size : 10 X ø7.2 cm

Packing Details : 57 X 34 X 25 cm ; 56 pcs / carton ; gw / nw : 10.1 kg / 8.1 carton

READY STOCK



DIA

DWXD 503 - Red DWXD 505 - Lime



Scan Below QR code to watch product video

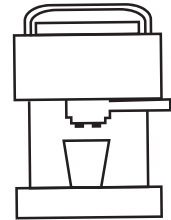

✓ Your ideal coffee partner

- 227 ml; Double Walled
- Easy To Clean
- Leak Proof
- Fits Under Your Coffee Machine

XDDESIGN™ Closable, insulated and compact enough for under the coffee machine (227 ml). It is also very hygienic because the lining of the mug is made of stainless steel and not from plastic. Designed to be completely dismantled at the end of its life-cycle. Registered design®

Print Technique : UV, SC, ENG

Preferred Print Location : Center

Max Print Size : ( Flat ) 25 x 60 mm , 170 x 60 mm ( Round )

Product Size : 8.5 x 9.2 x 10.2 cm

Packing Details : 54 x 40 x 39.5 cm ; 50 pcs / carton ; gw/nw: 13.7 kg / carton

**XDDESIGN™**

Orange



Designed by :



Antoine France



Lime

UI 1261 - URBAN

XDDESIGN™ Urban is a 400ml metal exterior mug which is ideal to use on your desk and to enjoy your coffee or tea. Stainless steel exterior has young & rich colors to add to the experience . Keeps your drink Hot for 3 Hrs & Cold for 6 Hrs. Registered design®

Print Technique : UV, SC

Preferred Print Location : Center

Max Print Size : ( Flat ) 30 x 70 mm

Product Size : 15.5 x 8.0 x 11.5 cm

Packing Details : 55.5 x 51.5 x 39 cm ; 40 pcs / carton ; gw/nw: 12.1 kg / carton

- Fresh Colors
- Designer Drinking Mug



SIERRA

DW XD 913- Black/ Anthracite DW XD 914- Silver / Black

XD XCLUSIVE™ Just the right size, a perfect fit for most coffee machines. This vacuum insulated double wall stainless steel design tumbler with silicone band detail. Keeps your drink hot for up to 5 hours and cold for up to 15 hours. Content: 280ml. Registered design®

Print Technique : UV, SC, ENG

Preferred Print Location : Front

Max Print Size : (Flat) 25 x 60 mm (Round) 200 x 80 mm

Product Size : 13.7 x 7.3 cm

Packing Details : 31 x 41 x 41 cm ; 50pc /carton; gw/nw : 10.25 kg / carton

- 280ml Leak Proof Vacuum Tumbler
- 5 Hours Hot And 15 Hours Cold



BOGOTA

DW XD 915 - Black

XD XCLUSIVE™ Don't taste your mug, just taste your drink! Enjoy this ceramic drinking experience. Keeps your drink hot for up to 5 hours and cold for up to 15 hours with this vacuum insulated tumbler. A ceramic all-over coating has been applied on the inner wall in order to have a better drinking experience and eliminate the metallic taste. Leak proof lid. Content: 500ml. Registered design®

Print Technique : UV, SC, ENG

Preferred Print Location : Front

Max Print Size : (Flat) 25x 80 mm (Round) 200 x 100 mm

Product Size : 20 x ø7.1 cm

Packing Details : 23.5 x 40 x 48 cm; 30pc /carton; gw/nw : 9.1 kg/carton

- 500ml Leakproof Vacuum Tumbler
- Ceramic Coated Inner Wall
- 5 Hours Hot And 15 Hours Cold
- Ceramic Coating Prevents Foul Odour



READY STOCK



LOCK MUG

DW XD 722 - Blue DW XD 723 - Green

XD DESIGN™ Lock allows you to safely drink and transport your drink to any location. The 250ml mug is easy to lock with one hand and made from durable 201 stainless steel with an inside PP lining. Designed in away that the mug is easy to take apart for recycling. Registered design®

Print Technique : UV, SC, ENG

Preferred Print Location : Front

Max Print Size : (Flat) 25 x 90 mm, (Round) 195 x 120

Product Size : 6.8 x 8.1 x 20 cm

Packing Details : 42 x 52.5 x 24.5 cm ; 30 pcs/carton; gw/nw : 2.5 kg / carton

- 250 ml Leak Proof Mug
- One Hand Operation
- Lockable Lid
- Can Be Completely Disassembled By Recycling





# MUGS

## XDDDESIGN®



**Coffee to go tumbler without handle**



**Coffee to go mug with handle**

- > Convenient Small Size, 160ml Fits Most Coffee
- > Machines Spill-Proof Lid



BEVAGE

DWXD 811 - Black DWXD 815 - Silver

XDDDESIGN® With 8 cm height, this is the perfect double wall mug for your coffee machine. PP inner. Great for your Espressos and Cappuccinos. Easy twist spill proof lid. Hand washable only. Content 160ml. Registered design®

Print Technique : UV, SC, ENG Preferred Print Location : Front Max Print Size : 25 x 20 mm  
Product Size : 10.0 x ø7.0 cm Packing Details : 26.0 x 34.0 x 54.5 cm ; 40pc /carton ; gw/nw : 6.16 kg / carton

## XDDDESIGN®



- > Double Walled ; 275 ml
- > Stylish & Trendy
- > Excellent Branding Space



POP MUG

DWXD 710 - Black DWXD 711 - White

XDDDESIGN® Pop is a fresh looking double wall plastic mug with frosted outside and sliding lid. 275ml content. Registered design®  
Print Technique : SC, UV Preferred Print Location : Front Max Print Size : ( Flat ) 20 x 90 mm ( Round ) 185 x 70 mm  
Product Size : 16.9 x 7.2 x 10.3 cm Packing Details : 42 x 69 x 39 cm ; 60 pcs/carton ; gw/nw : 14.5 kg/carton

READY STOCK

## Hans Larsen™ Drinkware

- > 470 ml Anti-Spill Mug
- > Leak Proof Design
- > Double Walled
- > Anti-Fall Suction Base

\* Image for representation purpose only. Do not try.



EJUNOIA

DWHL 205 - All White DWHL 206 - White-Blue Lid DWHL 207 - White-Grey Lid DWHL 208 - White-Black Lid

Hans Larsen™ 470 ml Double walled suction mug with outer body made from BPA free ABS and inside made from high grade stainless steel (SS 304) to ensure that your drink maintains its temperature for a long time. Strong vacuum suction pad at the bottom ensures that the mug holds firmly to the surface on which it is placed. Never worry about the drink spilling on to your table because it does not fall! Leakproof lid allows you to keep the mug in the bag, on your car seat, anywhere!

Print Technique : UV, SC Preferred Print Location : Center Max Print Size : (Flat) 30 x 140 mm, 160 x 32 mm (Round)  
Product Size : 22 x ø8.5 cm Packing Details : 45.5 x 45.5 x 24.5 cm ; 25 pcs/carton ; gw/nw : 10 kg/carton





**COLOR LOOP HORIZON MUG**

**HLVB 103** - White **HLVB 104** - Cream **HLVB 105** - Grey **HLVB 106** - Blue

Mug with a clean and flowing contour. Refined grey, sand and blue shades and a rough surface texture lend it an original, very special charm. Dishwasher and Microwave safe.

**READY STOCK**



**HLVB 107 - SIMPLY FRESH COFFEE MUG**

Beautiful does not always have to be different. Or does it? Or not? Or rather classic? This beautiful 350ml Simply Fresh mug allows for both. It combines simple elegance with fresh design. Dishwasher and Microwave safe.



**HLVB 108 - BASIC WHITE COFFEE MUG**

Basic white 300ml mug MADE IN GERMANY with elegant design in versatile classic white. These mugs are a perfect office desk companion. Dishwasher and Microwave safe.



# HAPPY MUGS & SUBLIMATION MUGS



DUBLIN

DWMK 105 - Sunglass

370ml, ceramic mug with fun emoji design in eye-catching yellow color. Presented in an individual box.

Print Technique : SC, UV Preferred Print Location : Front Max Print Size : 38 x 60 mm

Product Size: 8.2 x 9.8 cm Packing Details : 33 x 27.5 x 48 cms ; 36 pcs / carton ; gw / nw : 13 kg / carton

**OUTER WALL OF MUG CHANGES FROM BLACK TO WHITE**

WHEN HOT BEVERAGE IS ADDED, REVEALING LOGO.

**COLOR CHANGING MUG**

READY STOCK



DWLC 902 - SALTA

11 OZ Colour changing sublimation mug with matt finish



DWLC 901 - PARANA

11 OZ Sublimation mug



DWLC 201 - KAHVE

11 OZ ( 325ml ) Ceramic Mug With Matt Finish



# AN INTELLIGENT MUG WARMER & PHONE WIRELESS CHARGER use @ home, in office.



READY STOCK



Reinforced Porcelain



Neither wireless charging nor heating coil switches on accidentally due to foreign objects

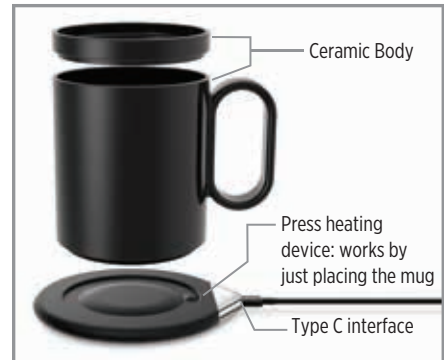

- Material- High Temperature-Safe on touching while ON
- Continuous 8 hours working
- Mug 350ml
- Constant temperature 55°C
- Supports Qi standard wireless charging of phones incl. Apple & Android upto 10W.



Intelligent Foreign object Recognition identifies metal items that are accidentally place in panel



Wireless / Heating panel is waterproof

CRIVITS

ITHL 534 - WIRELESS CHARGER CUM CUP WARMER

Hans Larsen™ Works with own cup / mug only as effectice contact points work in tandem with each other. This intelligent base recognises metal foreign objects placed accidentally and are not meant to be warmed or charged, Panel is waterproof & touch safe while on. The radio bottom cooling sheet dissipates heat at high temperature & accumulates heat when temperature is low, Mode of heating - wireless induction.

Print Technique : SC, UV

Print Location : Plate & Front of Mug Max Print Size : (Plate) 10 x 10 mm

Product Size : ø8.5 x 10.5 cm

Packing Details : 59 X 41 X 35 cm; 24 pcs/carton; gw/nw: 19.5/18.5 kgs /carton



READY STOCK

This Electric Lunch Box is in conformity with the technical requirements of the following standards:

EN60335-2-15:2016+A11:2018

EN60335-1:2012+AC:2014+A11:2014+A13:2017

+A1:2019+A14:2019+A2:2019

EN62233:2008

EN55014-1:2017/A11:2020

EN55014-2:2015

EN IEC 61000-3-2:2019

EN 61000-3-3:2013/A1:2019

- Maintains your lunch at a constant temperature
- A Daily-use quality product for everyone
- Can print individual names on top & company logo on front
- Quality confirms to European safety & quality requirements
- Choice of 2 fast-moving colors

CAZMA

ITLB 531 - Black ITLB 532 - White

Hans Larssen™ Electric Lunch Box continuously keeps your food warm at a constant temperature until you are ready to eat. When you gift CAZMA electric lunch box your logo is right in front of the eyes of the recipient & his / her family. This gift will create goodwill for your brand, continuously as it will get used over a long time period.

Print Technique : (Top) DM, (Side) SC Preferred Print Location : Top & Side Max Print Size : (Top) 5 x 20 mm (Side) 15 x 100 mm

Product Size : 22.1 x 13.5 X 8.5 cm Packing Details : 48.8 x 45.6 x 47.2 cm; 24 pcs/carton; gw/nw: 19.6 kg/carton





Black

- > Gift Set with color matched items
- > All items with premium soft touch coating
- > Vacuum Bottle, Metal Pen and A5 notebook in gift box



White



Grey



Blue



READY STOCK

LAUTA

GSGL 861 - Black GSGL 862 - White GSGL 863 - Grey GSGL 864 - Blue

Giftology Gift set containing vacuum water bottle, pen and notebook - with matching color and premium soft touch feel.

Water bottle - Soft touch double walled vacuum insulated stainless steel water bottle with 5h hot & 10h cold - 500ml.

Pen - Soft touch metal pen with German Dokumental ink of 1200m writing length.

Notebook - Soft touch Hard Cover A5 notebook with 160 pages / 70GSM paper

(Bottle) Print Technique : UV, SC, ENG

Preferred Print Location : Front

Max Print Size : 30 X 70 mm

(Notebook) Print Technique : UV, SC, EMB

Preferred Print Location : Front

Max Print Size : 210 X 140 mm

(Pen) Print Technique : UV, SC, ENG

Preferred Print Location : Barrel

Max Print Size : 50 X 6 mm

Packing Details : 57 x 31 x 41 cm; 10 pcs /carton ; gw/nw: 8.5 kg / carton



## GIFT SETS

READY STOCK



### GSCU 9506 - SKUTEC

Gift Set Option containing:

- ITBH 1109 - CHANGE Bamboo Bluetooth Wireless Headphones
- ITWC 1113 - CHANGE Bamboo 15W Wireless Charger
- ITGL 1125 - Bamboo Phone Grip



### GSCU 9507 - JAPONS

Gift Set Option containing:

- SCEN 9101 - Arabic Oud scented candle with bamboo lid
- NBEN 109 - A5 Hard Cover PU Notebook with bamboo design
- WIMP 269 - Black metal pen with bamboo clip



### GSCU 9505 - CESKY

Gift Set Option containing:

- IITPB 1112 - CHANGE Bamboo 10,000 mAh Wireless Powerbank
- ITGL 1124 - Bamboo (Smartphones and Tablets) Holder
- MTST 1111 - 6-in-1 charging cable
- DWHL 337 - CHANGE Stainless Steel Bottle with Bamboo Lid

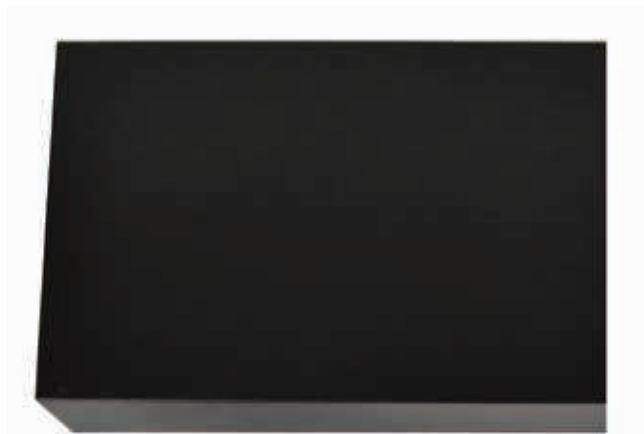



Black



White

READY STOCK

- Inner Temperature displayed on Flask Lid
- S.S. Flask- SS 304 Inner  
SS 201 Outer
- Food Grade: 8 hours hot,  
12 hours cold



SARGAN

GSGL 9501 - Black GSGL 9502 - White

Set of Stainless Steel Vacuum flask and A5 Notebook in an elegant set box

(Flask) Print Technique : SC, UV, ENG

Preferred Print Location : Front

Max Print Size : (Flat) 190 x 25 mm (Round) 190 x 204 mm

(Notebook) Print Technique : SC, UV

Preferred Print Location : Bottom center

Max Print Size : 130 x 205 mm

Product Size: (Flask) 23.7 x ø6.5 cm (Notebook) 13 x 21 x 1.4 cm

Box Size: 14 x 24.5 x 8.3 cm



GSCU 9503 - RUDEN  
Gift Set Option containing:  
DWHL 404 - Stainless Steel Reusable Water Bottle  
WIPP 603 - Ballpoint pen with Tungsten carbide ball  
NBSN 5126 - Wireless Charger Notebook with Phone stand



GSCU 9504 - RAGGAL  
Gift Set Option containing:  
DWGL 365 - Vacuum Double Walled Bottle  
WIMP 5105 - Twist action ballpoint metal pen  
OWMOL 301 - Moleskine Hard Cover A6 Pocket Notebook - Ruled  
GSMS 9105 - Premium quality Manicure / Grooming instruments set



READY STOCK



READY STOCK

- > Contemporary dining table accessory
- > Matching cork / glass design
- > Sustainable tableware



GSHL 3106 - ZOSSEN

Hans Larsen™ Zossen is an elegant, must-have gift set for every home or office dining table - Set of durable borosilicate glass carafe jar with cork lid, with 2 matching borosilicate glass tumblers with cork base. Carafe Capacity: 1.8L and Tumbler Capacity: 240ml each.

Print Technique : UV, SC

Preferred Print Location : Front

Max Print Size : (Carafe) 160 X 30 mm; (Cups) 25 X 15 mm





READY STOCK



- > Flask Capacity 600ml
- > Tumbler Capacity 180ml

ALMELO

GSHL 102 - Black GSHL 103 - Silver

For a daily fix of coffee even when you are running late, and a much-needed water break when you are out doing something or the other, this Flask and Tumbler Gift Set comes in very handy. Perfect for wherever and whenever, this SS 304 insulated flask & tumbler series keeps cold drinks cool and hot drinks warm.

Print Technique : UV, SC, ENG

Preferred Print Location : Front

Max Print Size : (Flask) (Flat) 30 x 140 mm (Round) 200 x 140 mm

Max Print Size : (Tumbler) (Flat) 30 x 60 mm (Round) 200 x 60 mm

Product size : (Flask) 29 X 7 cm (Tumbler) 10 X 7.2 cm

Packing Details : 47 x 37 x 46 cm ; 10 pcs /carton ; gw/nw: 11/12 kg / carton



Hans Larsen™  
Premium Drinkware

READY STOCK



- > Elegant Design Premium Set
- > Water Bottle & Flask Set
- > Packed In A Stylish Box

**GSHL 101 - LEIDEN**

Hans Larsen™ Leiden is a drinkware set consisting of a Tritan water bottle and Stainless Steel Vacuum Tumbler made from SS 304 inside and SS 201 outside.

Capacity: each 510 ml/ 17 OZ . The silicon grip ensures easy carry. Packed in a nice and presentable gift box.

Print Technique : SC, UV, ENG Preferred Print Location : Front Max Print Size : 130 x 40 mm

Product Size: 22.8 x ø7.2 cm Packing Details: 59.5 x 42.3 x 43 cm; 20 pcs /carton ; gw/nw: 11 kg / carton





READY STOCK



- >> SS Water Bottle with easy Grip & Flat Sides
- >> Bottle, Notebook & Pen Set In Gift Box

- >> Pen With German Dokumental® Ink
- >> 216 Pages Notebook With Legendary Flair

GSSN 101 - ARGAKI

SANTHOME Gift set consisting of a double wallet water bottle, pen and notebook. The water bottle keeps liquids cold for up to 12 hours and hot for 8 hours without any sweating on the exterior. Notebook is a retro piece of art that gels perfectly with the hexagonal body pen having German Dokumental® ink. A perfect gift that communicates modern flair.

(Notebook) Print Technique : SC, FO, UV, EMB  
 (Pen) Print Technique : SC, UV, ENG  
 (Bottle) Print Technique : UV, SC, ENG  
 Product Box Size : 28 X 25.5 X 9 cm

Preferred Print Location : Front  
 Preferred Print Location : Barrel  
 Preferred Print Location : Front  
 Packing Details : 66.5 X 55.5 X 29 cms ; 16 pcs / carton ; gw / nw : 16.3 kg / carton

Max Print Size : 160 x 100 mm  
 Max Print Size : 25 x 6 mm  
 Max Print Size : 30 x 120 mm



Useful eco-conscious gift set with sustainable packaging:

**Notebook** - Kraft cover with FSC-certified paper inside

**Mug** - Wheatstraw material with silicone sleeve

**Pen** - Made with wheatstraw material

VALUE

READY STOCK



Wheatstraw Mug w/ silicone



Notebook with FSC paper



Wheatstraw Pen

- All products plus packaging from sustainable materials
- Silicone sleeve helps hold mug with hot liquid
- 80 pgs Notebook - 14 x 9 cm, 70 gsm
- Give VALUE, Save Ecology when you give out this set
- 380 ml Mug capacity



GSEN 681 - KORGAN

(Notebook) Print Technique : SC, UV

(Pen) Print Technique : SC, UV

(Mug) Print Technique : SC

Box Size: 14.5 x 10.3 x 9.7 cm; Each set of 3 in box weighs 176 gms

Preferred Print Location : Front

Preferred Print Location : Clip

Preferred Print Location : Front

Max Print Size : 70 x 130 mm

Max Print Size : 7 x 35 mm

Max Print Size : 30 x 50 mm



READY STOCK



➤ Bamboo & Packaging-sustainable

Set of Eco Lunch Box & Vacuum Bottle  
GSHL 180 - CHAVES

Hans Larsen® (BOTTLE) Double wall stainless steel insulating vacuum flask with bamboo lid and carry handle. Capacity: 500 ml. Leak Proof Material- SS 304 Inside SS 201 Outside.  
(LUNCH BOX) Stainless Steel lunchbox with bamboo lid and 2 cutlery utensils with attachable polyester band. Capacity 700ml. Bamboo is a natural product, there may be slight variations in colour and size per item. Material- SS 304 Food Grade

(BOTTLE) Print Technique : SC, UV, ENG Preferred Print Location : Bottle Front & Top  
(LUNCH BOX) Print Technique : SC, ENG Preferred Print Location : Lunch Box Top & Side  
Box Size : 25.5 x 25.5 x 7.5 cm; Box with both items weighs 715 gms

Max Print Size : (Front) 30 x 40 mm (Top) ø 45 mm  
Max Print Size : (Top) 90 x 30 mm (Side) 30 x 100 mm



Exclusive glassware made by professional glassmakers in Italy. The base is created using the most sophisticated technology and the decoration is completely done by hand by experienced craftsmen in this field.



READY STOCK

### Caffè Deborah Cup Set - Versac Gold Black



**HLSAN 203 - CAFÉ DEBORAH**

Packing Size : 27 x 19.5 x 9 cms

Packing Details : 42 x 30 x 29 cm

6 set /carton ; gw/nw: 2.92 kg / carton

Print Technique : SC

**HLSAN 202 - CAFÉ DEBORAH**

Packing Size : 38 x 29.5 x 9.5 cms

Packing Details : 62 x 40 x 33 cm

6 set /carton ; gw/nw: 5.83 kg / carton

Preferred Print Location : Opp.Handle

**HLSAN 201 - CAFÉ DEBORAH**

Packing Size : 48 x 31.5 x 12.5 cms

Packing Details : 65 x 50 x 40 cm

6 set /carton ; gw/nw: 8.75 kg / carton

Max Print Size : 20x5mm



*Exclusive glassware made by professional glassmakers in Italy. The base is created using the most sophisticated technology and the decoration is completely done by hand by experienced craftsmen in this field.*



**Tea Deborah Cup Set - Versac Gold Black**

READY STOCK



**HLSAN 206 - TEA DEBORAH**  
Packing Size : 27 x 19.5 x 9 cm  
Packing Details : 62 x 30 x 29 cm  
6 set/carton ; gw/nw: 4.26 kg / carton

Print Technique : SC

**HLSAN 205 - TEA DEBORAH**  
Packing Size: 38 x29.5 x9.5 cm  
Packing Details : 62 x 40 x 33 cm  
6 set /carton ; gw/nw: 8.53 kg / carton

Preferred Print Location : Opp.Handle

**HLSAN 204 - TEA DEBORAH**  
Packing Size: 48 x 31.5 x 12.5 cm  
Packing Details : 65 x 50 x 40 cm  
6 set /carton ; gw/nw: 12.79 kg / carton

Max Print Size: 30x10mm

# Recycled Polo

## Our Transparent Process

**COLLECTION**  
of plastic bottles,  
removing labels & foreign materials,  
making it process - ready



**COLLECTION**  
of cotton fabric waste,  
also called post-industrial  
cotton waste, making it  
process-ready



**SHREDDING**  
Used water bottles into  
fiber, certified by the  
Global Recycled Standard



**SHREDDING**  
post-industrial cotton waste  
into fiber, certified by the  
Global Recycled Standard



**YARNS**  
produced by spinning the fiber



**YARNS**  
produced by spinning the  
fiber



**FABRIC**  
produced by using cotton &  
plastic yarns together



**APPAREL**  
produced from the Recycled fabric,  
certified by the Global Recycled Standard



**VERIFICATION DOCUMENT**  
available, as the above process is  
entirely transparent

**GREENWASHING DISCOURAGED**  
by using above verifiable process,  
ensuring positive impact on  
environment



**PLEGGED DONATION**  
of 3% of sales proceeds to  
water.org ensures safe water  
& sanitation to the needy

**Plastic Bottles**  
recycled, positive impact



**RECYCLED COTTON**  
ensures fresh cotton is  
not used, positive impact



**WATER SAVINGS**  
as fresh cotton fabric  
production consumes  
huge quantities of water



SANTHOME

**PRO EARTH**  
SHIRT IS MADE FROM  
17 PLASTIC BOTTLES



THIS SHIRT HAS SAVED  
1,260L OF WATER

SANTHOME

**PRO EARTH**  
FULLY RECYCLED POLO

MADE FROM  
60% RECYCLED COTTON  
AND 40% RECYCLED PET





The PRO EARTH Polos from Santhome use

LESS WATER • LESS CHEMICALS • LESS EMISSION • LESS ENERGY • LESS WASTE • REDUCE CARBON FOOTPRINT



Navy Blue



White



READY STOCK



Black

-1,260L

17

> 3% of sales proceeds of this Polo committed to Water.org by the brand owners

Item : PRO Earth Polo

Content : 40% Recycled PET, 60 % Recycled Cotton

Measurement : Gulf Sizes

Sizes Available : S- XXXL

Care Instructions:

Print Technique :

- 1 Screen Printing
- 2 Heat Transfer
- 3 Embroidery

Preferred Print Location : Max Print Size:  
Left Chest Area / Sleeve 80 x 50 mm

PRO EARTH POLO

**CHANGE.**  
SERIOUS SUSTAINABILITY

THIS SHIRT IS MADE FROM 17 PLASTIC BOTTLES

THIS SHIRT HAS SAVED 1,260L OF WATER

SANTHOME

**PRO EARTH**  
FULLY RECYCLED POLO

MADE FROM 60% RECYCLED COTTON AND 40% RECYCLED PET

**THE GIFT OF WATER**

For each product sold, the brand owner will donate 3% of sales to support Water.org to change lives with safe water and sanitation

a US-based 501(c)(3) global non-profit organization

**785M**

785 million people - 1 in 9 - lack access to safe water

We are supporting Water.org to change this

**READY STOCK**







Colours in Ready Stock\*



Charcoal Grey



White



Maroon



Grey Melange



Black



Royal Blue



Navy Blue



Red

Item : BDNC | Content : Dryncool fabric with UV protection  
Measurement : Gulf | Sizes Available : S, M, L, XL, XXL, 3XL

Dryncool is an advanced Moisture Management system (MMS) that helps keep the skin cooler & drier - more comfortable by transporting sweat to outer layer.

Executive wear.

Premium quality.

No-fuss performance.

Creaseless.

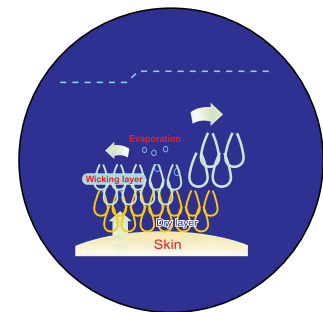

Dryncool Mechanism

READY STOCK

UV protection fabrics are rated between UPF 25-39. Ultraviolet protection factor(UPF) measures blockage of UV-A and UV-B rays. A UPF rating of 25-39 means that our fabric allows 1/25th to 1/39th (2.56- 4%) of UV radiation that falls on the surface of the fabric to pass through it. Thus, 96-97.4% of UV rays are not allowed to reach your skin thereby protecting the skin from sunburn and long term skin damage.



Tagless label

Print Technique :

- 1 Screen Printing
- 2 Heat Transfer
- 3 Embroidery

Preferred Print Location : Max Print Size:  
Left Chest Area / Sleeve 80 x 50 mm

Care Instructions:



Packing:

52.5x 32.5x 45 cms ; 50 pcs /carton ; gw/nw: 21.5kg / carton  
\* Packing details may have ± 10% variation based on size breakup



Side slits with bartack

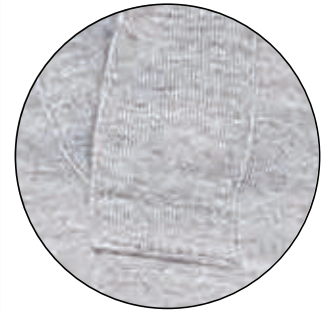

Double placket

\* Printing Limitations prevent exact fabric and color representation.  
The shades in the lots may differ due to lot-to-lot variations.  
The difference is no more than internationally accepted norms of the garments trade.

READY STOCK

Light weight, Special Knit fabric,  
with DrynCool & UV Protection Function



(Colours in Ready Stock\*)



UV protection fabrics are rated between UPF 25-39. Ultraviolet protection factor (UPF) measures blockage of UV-A and UV-B rays. A UPF rating of 25-39 means that our fabric allows 1/25th to 1/39th (2.56- 4%) of UV radiation that falls on the surface of the fabric to pass through it. Thus, 96- 97.4% of UV rays are not allowed to reach your skin thereby protecting the skin from sunburn and long term skin damage.



Distinctive Triple Needle Stitch at seams

READY STOCK



Tagless high quality label

Item : ADF (ALLDAYFRESH) | Content : Dryncool Sports fabric  
Measurement : Gulf | Sizes Available : S, M, L, XL, XXL, 3XL

Print Technique :

- 1 Screen Printing
- 2 Heat Transfer
- 3 Embroidery

Preferred Print Location : Max Print Size:

Left Chest Area / Sleeve 80 x 50 mm

Care Instructions:



Packing:

51 x 36x 41cm; 50 pcs/carton; gw/nw: 14.2kg/carton  
\* Packing details may have ± 10% variation based on size breakup



Side slits with Bartack



Trendy DTM buttons

\* Printing Limitations prevent exact fabric and color representation. The shades in the lots may differ due to lot-to-lot variations. The difference is no more than internationally accepted norms of the garments trade.

READY STOCK

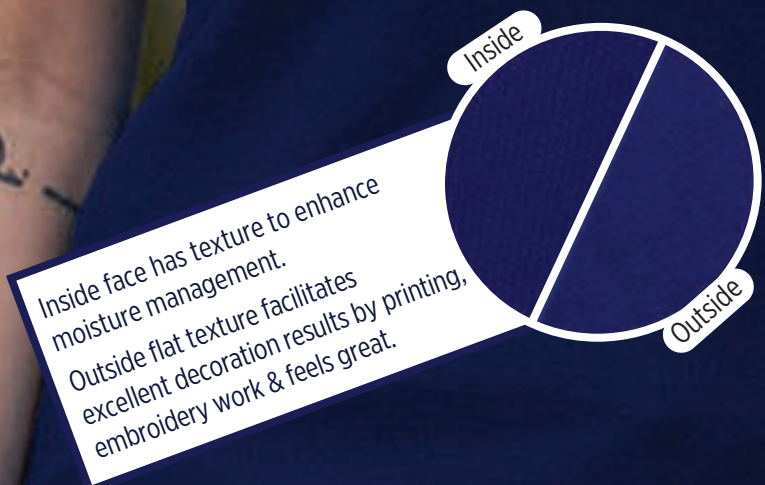



Colours in Ready Stock\*



Black



White



Navy Blue



Grey Melange

Item : WBDNC | Content : Dryncool fabric with UV protection  
Measurement : Gulf | Sizes Available : S, M, L, XL, XXL, 3XL

Dryncool is an advanced Moisture Management system (MMS) that helps keep the skin cooler & drier - more comfortable by transporting sweat to outer layer.

Executive wear.

Premium quality.

No-fuss performance.

Creaseless.

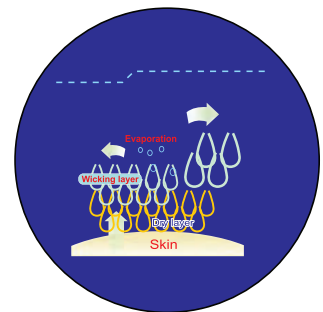

Dryncool Mechanism

READY STOCK

UV protection fabrics are rated between UPF 25-39. Ultraviolet protection factor(UPF) measures blockage of UV-A and UV-B rays. A UPF rating of 25-39 means that our fabric allows 1/25th to 1/39th (2.56- 4%) of UV radiation that falls on the surface of the fabric to pass through it. Thus, 96-97.4% of UV rays are not allowed to reach your skin thereby protecting the skin from sunburn and long term skin damage.



Tagless label

Print Technique :

- 1 Screen Printing
- 2 Heat Transfer
- 3 Embroidery

Preferred Print Location : Max Print Size:  
Left Chest Area / Sleeve 80 x 50 mm

Care Instructions:



Packing:

52.5x 32.5x 45 cms ; 50 pcs /carton ; gw/nw: 21.5kg / carton  
\* Packing details may have ± 10% variation based on size breakup



Side slits with bartack

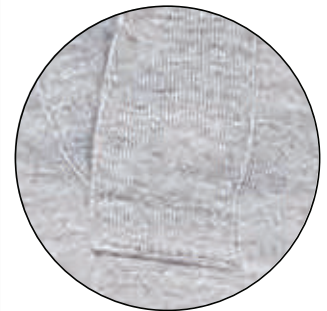

Double placket

\* Printing Limitations prevent exact fabric and color representation. The shades in the lots may differ due to lot-to-lot variations. The difference is no more than internationally accepted norms of the garments trade.

THE GRAND BUCK  
COLLECTION



READY STOCK

Pique Textured cotton rich  
Dryncool performance fabric

# THE GRAND BUCK COLLECTION HIGHLANDER<sup>(i)</sup> POLO SHIRTS FOR ADULTS



## Colours in Ready Stock \*



White cloud  
(White / Light melange)



Terracotta  
(Red/Navy)



Lava  
(Black/Dark melange)



Gulf blue  
(Navy blue/Red)



Ebonite  
(Dark melange/Black)



Royal Blue/Black



Item: HIGHLANDER | Content: Cotton rich Dryncool performance fabric  
Measurement: Gulf | Sizes Available: S, M, L, XL, XXL, 3XL

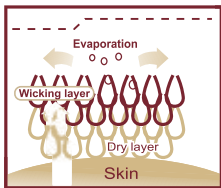

...using special technology this fabric pulls out the moisture away from the skin to the surface of the fabric for quick evaporation, which keeps your body dry and comfortable.

"When you are looking for a performance polo that withstands the daily wash and wear only a HIGHLANDER will meet your expectations.

It has the right feel, fit, weight and the resilience.

This Dryncool material, predominantly composed of cotton, retains its charm - wash after wash"

### Print Technique :

- ① Screen Print    ② Heat Transfer    ③ Embroidery

Preferred Print Location : Max Print Size:

Left Chest Area / Sleeve

80 x 50 mm

### Care Instructions:



### Packing:



52.5 x 32.5 x 40cm; 50 pcs/carton; gw/nw: 17kg/carton

\* Packing details may have ± 10% variation based on size breakup

\* Printing Limitations prevent exact fabric and color representation.

The shades in the lots may differ due to lot-to-lot variations.

The difference is no more than internationally accepted norms of the garments trade.



Neck tape & inside  
Placket in contrast



Trendy HORN button



Trendy double placket



Contrast side slits with  
bartack detailing

READY STOCK

(i) HIGHLANDER from the THE GRAND BUCK COLLECTION is manufactured with pride under license from SANTHOME HOLDINGS LTD. ( BVI).

# CARRIBEAN

READY STOCK

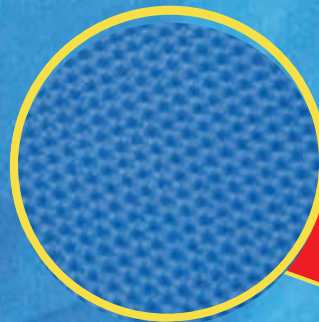

Light-weight Special texture fabric with MMS Technology





## Colours in Ready Stock



Navy



Black



White



Medium Blue



Red



Blue



Grey



Tagless label

READY STOCK

Item : Carribean | Content : 100% Polyester  
Measurement : Gulf | Sizes Available : XS, S, M, L, XL, XXL, 3XL

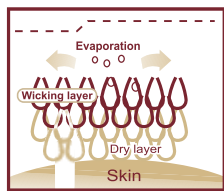

...using special technology this fabric pulls out the moisture away from the skin to the surface of the fabric for quick evaporation, which keeps your body dry and comfortable.

### Print Technique :

- 1 Screen Printing
- 2 Heat Transfer
- 3 Embroidery

Preferred Print Location :

Left Chest Area / Sleeve

Max Print Size:

80 x 50 mm

### Care Instructions:



### Packing:



51 x 36 x 41 cm; 50 pcs/carton; gw/nw: 14.2kg/carton

\* Packing details may have ± 10% variation based on size breakup



Trendy Embossed Button



Contrast Tripple Needle Stitch



Trendy Short Collar

\* Printing Limitations prevent exact fabric and color representation.  
The shades in the lots may differ due to lot-to-lot variations.  
The difference is no more than internationally accepted norms of the garments trade.

READY STOCK

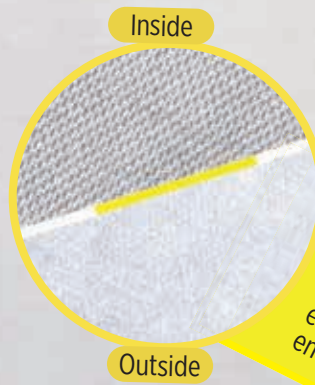

Inside face has texture to enhance moisture management.  
Outside flat texture facilitates excellent decoration results by printing, embroidery work & feels great.



### Colours in Ready Stock\*



White - Red / Navy



Black - Red / Grey



Navy - Red / Grey



Grey - Navy / White

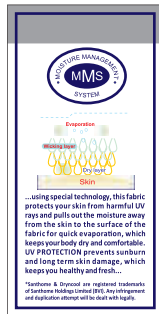

Dryncool is an advanced Moisture Management system (MMS) that helps keep the skin cooler & drier - more comfortable by transporting sweat to outer layer.

Executive wear.

Premium quality.

No-fuss performance.

Creaseless.



Item : Tropikana | Content : Dryncool fabric with UV protection  
Measurement : Gulf | Sizes Available : S, M, L, XL, XXL, 3XL

The subtle combinations of corporate colors on sleeves, collar, placket & pocket give a modern, stylish, yet a corporate look to this polo.

UV protection fabrics are rated between UPF 25-39. Ultraviolet protection factor (UPF) measures blockage of UV-A and UV-B rays. A UPF rating of 25-39 means that our fabric allows 1/25th to 1/39th (2.56- 4%) of UV radiation that falls on the surface of the fabric to pass through it. Thus, **96- 97.4% of UV rays are not allowed to reach your skin** thereby protecting the skin from sunburn and long term skin damage.

Print Technique :

- 1 Screen Printing
- 2 Heat Transfer
- 3 Embroidery

Preferred Print Location :

Left Chest Area / Sleeve

Max Print Size:

80 x 50 mm

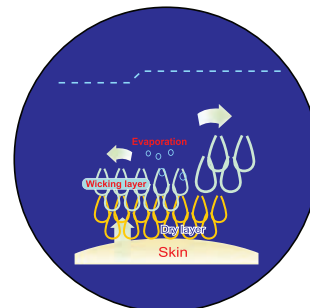

Dryncool Mechanism



Tagless Label

Care Instructions:



Packing:



52.5 x 32.5x 45 cm ; 50 pcs/carton ; gw/nw: 16kg / carton

\* Packing details may have ± 10% variation based on size breakup

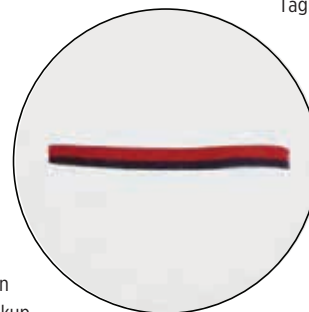

Patchless concealed pocket



Side slits with bartack

\* Printing Limitations prevent exact fabric and color representation.  
The shades in the lots may differ due to lot-to-lot variations.  
The difference is no more than internationally accepted norms of the garment trade.

READY STOCK

*Greberry*



READY STOCK





### Colours in Ready Stock\*



White / Grey



White / Blue



White / Red

**Greberry**  
a premium polo

A Concept Bordering between  
FASHION & CORPORATE WEAR !

From the  
**SANTHOME**<sup>®</sup>  
Polo collection

SANTHOME is a registered trademark owned by SANTHOME HOLDINGS LTD. (BVI).

- Details :-
- DrynCool fabric
  - UV Protection By Resil
  - Grey Berries for the Design Element
  - Subtle-lined & Berry - infused collar
  - Silicone sleeve tag breaks the monotony
  - The first button thread catches your attention
  - Bottom slit for comfortable postures
  - Frosted Button
  - Regular Fit
- Have we missed anything?

Break out from the routine of standard basic designs, & embrace the new Corporate Fashion Polo; Introducing Greberry by **SANTHOME**

The Grey Berries (of Greberry fame) around the shoulder & on the collar infuse the subtle design aspect without being loud.



UV protection fabrics are rated between UPF 25-39. Ultraviolet protection factor (UPF) measures blockage of UV-A and UV-B rays. A UPF rating of 25-39 means that our fabric allows 1/25th to 1/39th (2.56-4%) of UV radiation that falls on the surface of the fabric to pass through it. Thus, **96-97.4% of UV rays are not allowed to reach your skin** thereby protecting the skin from sunburn and long term skin damage.



Berries on sleeve

READY STOCK

Item : Greberry | Content : Dryncool Sports fabric with UV protection  
Measurement : Gulf | Sizes Available : S, M, L, XL, XXL, 3XL

### Print Technique :

- 1 Screen Printing    2 Heat Transfer    3 Embroidery

Preferred Print Location : Max Print Size:  
Left Chest Area / Sleeve    80 x 50 mm

### Care Instructions:



### Packing:



52.5 x 32.5 x 45 cms ; 50 pcs /carton ; gw/nw: 16kg / carton  
\* Packing details may have + 10% variation based on size breakup



Trendy silicon brand tag



Frosted top button with contrast color stitch

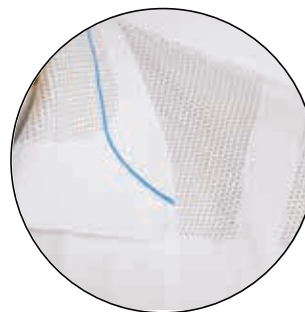

Collar design

\* Printing Limitations prevent exact fabric and color representation. The shades in the lots may differ due to lot-to-lot variations. The difference is no more than internationally accepted norms of the garments trade.

# GOLF POLOS

READY STOCK





Colours in Ready Stock\*



Navy Blue



Anthra



Purple Toned Burgundy



Beige



Sky Blue

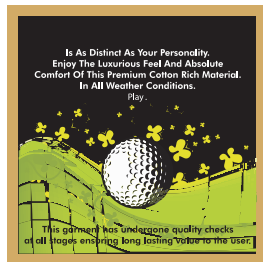

Premium Golf Polo in pre-dyed yarn. Quality comparable to top brands. Collar is high quality jacquard in yarn dyed. Collar band and Placket in biased contrast stripes matching to body.

Item : Golf Polo Limited Edition | Content : Pre-Dyed Two Tone, all-weather fabric.  
Measurement: Gulf | Sizes Available : S, M, L, XL, XXL, XXXL

Print Technique :

- 1 Screen Printing
- 2 Heat Transfer
- 3 Embroidery

Preferred Print Location : Max Print Size:  
Left Chest Area / Sleeve 80 x 50 mm

Care Instructions:



Packing:

56x 36x 36cms ; 50 pcs /carton ; gw/nw: 15.30kg / carton  
\* Packing details may have + 10% variation based on size breakup

\* Printing Limitations prevent exact fabric and color representation. The shades in the lots may differ due to lot-to-lot variations. The difference is no more than internationally accepted norms of the garment trade.



High quality pre - dyed Jacquard collar in matching body color

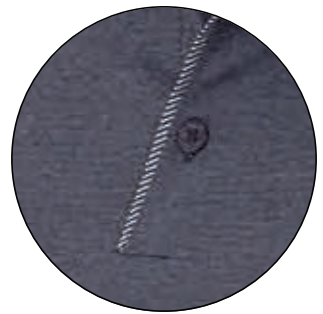

Matching biased placket and edge piping

READY STOCK



Matching collar band



Freedom sleeves, no cuffs

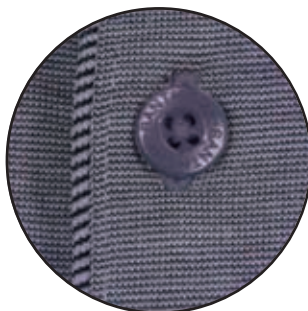

Embossed buttons

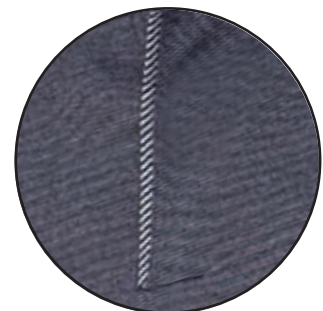

Thick needle stitch at end-of-placket



THE IMPROVED BDNC POLO



THE  
ANTI-MICROBIAL  
DRYnCOOL  
EXECUTIVE  
POLO SHIRT



Red



White



Item : SECURE | Content : Dryncool fabric  
Measurement : Gulf | Sizes Available : S, M, L, XL, XXL, 3XL

SILAIDE 100 Anti Microbial Polo  
Premium executive wear  
No-fuss performance.  
Creaseless.  
Dryncool Moisture Management Technology

READY STOCK



Print Technique :

- 1 Screen Printing
- 2 Heat Transfer
- 3 Embroidery

Preferred Print Location : Max Print Size:

Left Chest Area / Sleeve 80 x 50 mm

Care Instructions:



Packing:

53 x 33 x 45cm; 50 pcs/carton ; gw/nw: 15/16kg / carton  
\* Packing details may have ± 10% variation based on size breakup

\* Printing Limitations prevent exact fabric and color representation.  
The shades in the lots may differ due to lot-to-lot variations.  
The difference is no more than internationally accepted norms of the garments trade.

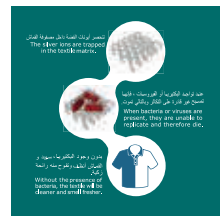
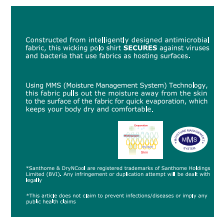

Tagless label



Side slits with bartack

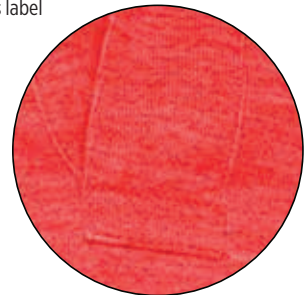

Double placket



HEIQ SWISS  
TECHNOLOGY

VIROBLOCK  
ANTIVIRAL  
PROTECTION



White



Black



Navy

Item: Shield | Content: 100% Polyester  
Measurement : Gulf | Sizes Available : S, M, L, XL, XXL, 3XL

VIROBLOCK ANTI VIRAL PROTECTION

Executive wear.

Premium quality.

No-fuss performance.

Creaseless.

Print Technique :

- 1 Screen Printing
- 2 Heat Transfer
- 3 Embroidery

Preferred Print Location : Max Print Size:

Left Chest Area / Sleeve

80 x 50 mm

Care Instructions:



Packing:



51 x 36 x 41cm ; 50 pcs /carton ; gw/nw: 14/12kg / carton

\* Packing details may have ± 10% variation based on size breakup

\* Printing Limitations prevent exact fabric and color representation.  
The shades in the lots may differ due to lot-to-lot variations.  
The difference is no more than internationally accepted norms of the garments trade.

مصنوع من قماش معزز للميكروبات معمم بذلك، تم تصميمه لجلب أفضل أداء للبولو المضاد للبكتيريا والفيروسات التي تستخدم الأقمشة كمنسج للتلويح.

منسج هيك فيرو بلاك متوافق مع كل من منتجات المبيدات الحيوية للإنتاج الأوروبي ، ومع القانون الاتحادي للمبيدات الحشرية ، ومبيدات الفطريات، ومبيدات الفوارس في الولايات المتحدة.

\*Santhome & DrynCool are registered trademarks of Santhome Holdings Limited (SHV). Any infringement or duplication attempt will be dealt with legally.

\*This article does not claim to prevent infections/diseases, or make any public health claims

”ستقوم ادرع ان كبلت علة ادرع مسجلة كعلامة مسجلة في السويد (SHV). اي انتهاك او تكرار غير مصرح به سيتم التعامل مع اى محاولة لتقليد او النسخ بشكل قانوني.

لا الهة ادرع لا تضمن اقلية من الامراض المعدية او تنقلها اذ مرزا من نقل بالعبء المعدية

الدرع  
SHIELD

by  
SANTHOME®

من  
سانت هوم®

هيك  
فيرو بلاك  
للمخاية من الفيروسات  
والبكتيريا

HEIQ  
VIROBLOCK  
ANTIVIRAL PROTECTION

ANTIVIRAL ANTIBACTERIAL

تتميز بتركيب القماش الذي يحبس الفيروسات والبكتيريا في القماش.

When bacteria or viruses are present, they are unable to replicate and therefore die.

لا الهة ادرع لا تضمن اقلية من الامراض المعدية او تنقلها اذ مرزا من نقل بالعبء المعدية

الدرع  
SHIELD

by  
SANTHOME®

من  
سانت هوم®

هيك  
فيرو بلاك  
للمخاية من الفيروسات  
والبكتيريا

HEIQ  
VIROBLOCK  
ANTIVIRAL PROTECTION

SIZE L

Tagless label

READY STOCK

# TECK

READY STOCK



Light weight, Special Knit fabric,  
with DrynCool & UV Protection Function



Why the name Teck? It's Sports garment Technology at its best! In this Knowledge-based world, the users will be the Young and the Not-So-Young who leverage their knowledge in the daytime and like to perform sports and work-outs in the other times.



White / Red



White / Navy Blue



White / Black

UV protection fabrics are rated between UPF 25-39. Ultraviolet protection factor (UPF) measures blockage of UV-A and UV-B rays. A UPF rating of 25-39 means that our fabric allows 1/25th to 1/39th (2.56- 4%) of UV radiation that falls on the surface of the fabric to pass through it. Thus, 96- 97.4% of UV rays are not allowed to reach your skin thereby protecting the skin from sunburn and long term skin damage.



Sports design

READY STOCK

Item : Teck | Content : Dryncool Sports fabric with UV protection  
Measurement : Gulf | Sizes Available : S, M, L, XL, XXL, 3XL

Print Technique :

- 1 Screen Printing
- 2 Heat Transfer
- 3 Embroidery

Preferred Print Location : Max Print Size:  
Left Chest Area / Sleeve 80 x 50 mm

Care Instructions:



Packing:

51 x 36x 41cm; 50 pcs/carton; gw/nw: 14.2kg/carton  
\* Packing details may have ± 10% variation based on size breakup



Tagless high quality label



Trendy DTM buttons

\* Printing Limitations prevent exact fabric and color representation.  
The shades in the lots may differ due to lot-to-lot variations.  
The difference is no more than internationally accepted norms of the garments trade.



# ORCA<sup>[i]</sup> MERCERIZED GOLF POLO SHIRTS

Colours in Ready Stock\*



Cobra  
(Khaki/Black)



Midnight Sky  
(Navy/Khaki)

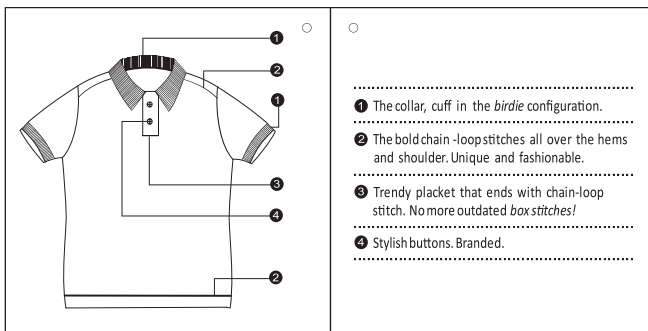

"ORCA is found in Antarctica and Arctic oceans. Also called 'Killer Whales', it is the largest of the Dolphin family. They are beautiful, intelligent, fast, strong and yet the most social of all sea animals! They are said to have great tolerance in varying temperatures. That is the reason they enjoy world-wide distribution. Most interestingly, it's the only species in the world that has both the male and the female offspring stay with their mothers and immediate family forever...!"

These wonderful creatures have inspired us to bring to you exclusive polos. Their 'killer look', beauty, sheen and lustre is attributed to the MERCERIZING process. The premium cotton rich material makes it extremely comfortable in all climatic conditions. The collar, cuff in the birdie configuration sets new standards in their making. The bold loop stitches all over the hems and shoulder make them unique and yet resilient. Finally just as the ORCA, this polo will stay with you for long time to come.

Shouldn't then it be called the ORCA POLO?"

**Item :** ORCA | **Content :** Premium Cotton rich MERCERIZED fabric  
**Measurement :** Gulf | **Sizes Available :** S, M, L, XL, XXL, 3XL

### Print Technique :

- 1 Screen Print
- 2 Heat Transfer
- 3 Embroidery

**Preferred Print Location :** Max Print Size:

Left Chest Area / Sleeve      80 x 50 mm



### Care Instructions:

#### Packing:



56 x 36x 40 cm ; 50 pcs /carton ; gw/nw: 15.7kg / carton

\* Packing details may have +10% variation based on size breakup

\* Printing Limitations prevent exact fabric and color representation. The shades in the lots may differ due to lot-to-lot variations. The difference is no more than internationally accepted norms of the garment trade.

[i] Orca is manufactured under license from SANTHOME HOLDINGS LTD. (BVI).

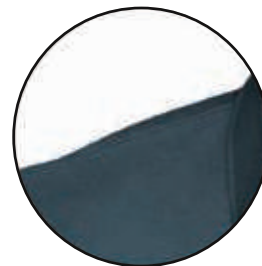

Unique bold loop stitching on shoulder & all hems



Unique birdie configuration collar/cuff

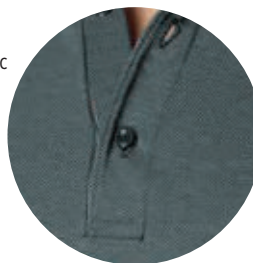

Unique bold loop stitching at end of placket



Thick side embossed button

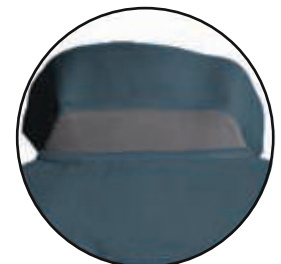

Trendy 'Picaso' collar

READY STOCK

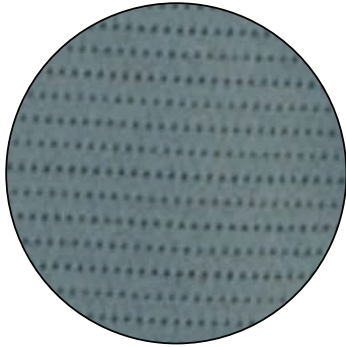

Special textured 2-tone knit fabric



Dark Grey



White

**READY STOCK**

- Swing+ Tech swing support mechanism
- Enhanced stretch for better range of motion
- UV protection against harmful UV sunlight
- Moisture wicking DryNcool® fabric
- Lightweight fabric

**سانديز اند بت**  
من  
**سانتوم**  
غولف • ليجاسي

حماية من الأشعة فوق البنفسجية  
ابق متعشاً

*Sandies & Putt*  
by  
**SANTHOME**  
Golf • Legacy

UV Protected  
Stay Fresh

\* تحتوي اشعة الشمس على الأشعة فوق البنفسجية الضارة ، و التي تسبب في حروق الشمس و جفاف البشرة مع هذا القميص الخاص من بواو يتم استخدام تكنولوجيا تعمل على منع حروق الشمس، الأضرار المزمنة التي تحدث للبشرة حتى تتكيف من الامتصاص للشمس في املاء.

\* يستخدم تقنية (نظام معالجة الرطوبة) ، يقوم هذا السيج بطرد الرطوبة بعيداً عن البشرة الى سطح السيج حيث يتبخر سريعاً مما يحافظ على جفاف و راحة جسمك .

\* باتيكم هذا السيج المصنع بتقنية نظام معالجة الرطوبة في تصاميم مميزة و يعمل بطريقة ممتازة على التهوية بالسج مما يجعله أكثر راحة.

**معالجة الرطوبة**  
MMS  
نظام

**Evaporation**  
Moisture  
Skin

\* Sun rays contain harmful UV rays which causes sunburn and damage to skin. This special polo uses a technology that prevents sunburn, long term skin damage and you can enjoy sun safely.

\* Using MMS (Moisture Management System) technology, this fabric pulls out the moisture away from the skin to the surface of the fabric for quick evaporation, which keeps your body dry and comfortable.

This PERFORMANCE fabric with MMS in the special Knit Design works as excellent Ventilation for free breathing of fabrics, making it more comfortable.

**Evaporation**  
Moisture  
Skin

**MOISTURE MANAGEMENT SYSTEM**  
MMS

\*Santhome & Dryncool are registered trademarks of Santhome Holding Limited (BVI). Any infringement and duplication attempt will be dealt with legally.

Item : SNP  
Content : 100% polyester, Special Knit  
Measurement : Gulf Sizes Available : S, M, L, XL, XXL, 3XL  
Print Technique :  
① Screen Printing ② Heat Transfer ③ Embroidery  
Preferred Print Location : Left Chest Area / Sleeve  
Max Print Size: 80 x 50 mm



EXCLUSIVE QUALITY 2PLY  
100% COTTON REGLAN POLO SHIRTS

# REGLAN

REGLAN



Colours in Ready Stock\*



White / Royal Blue



White / Navy Blue



2 ply ring special yarn ensure lasting feel & Performance



White / Red

READY STOCK

**SANTHOME**  
BY  
**SELECT**  
Since 1989

100% cotton. 260 GSM 2 ply super combed pique polo.. ie. same as MACY fabric. Trendy Executive Wear. Premium quality comparable to brands. Performance for colour fastness, shrinkage and shape retention. Collar/Cuff has contrast tipping. Reglan sleeves has contrast piping.

Item : REGLAN Polo | GSM : 260/265

Content : 100% cotton. 2ply Premium super combed yarn

Measurement : Gulf | Sizes Available : S, M, L, XL, XXL

Print Technique :

- ① Screen Printing
- ② Heat Transfer
- ③ Embroidery

Preferred Print Location : Max Print Size:

Left Chest Area / Sleeve

80 x 50 mm

Care Instructions:



Packing:



56.5 x 34x 42.5 cm ; 50 pcs /carton ; gw/nw: 19.2kg / carton

\* Packing details may have ± 10% variation based on size breakup

\* Printing Limitations prevent exact fabric and color representation.

The shades in the lots may differ due to lot-to-lot variations.

The difference is no more than internationally accepted norms of the garment trade.



Trendy embossed buttons

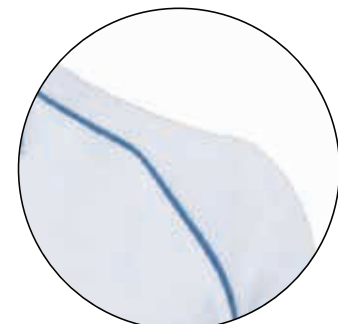

Contrast piping and tipping



Double pique texture in two ply ensures lasting feel and performance, wash after wash.

Colours in Ready Stock \*

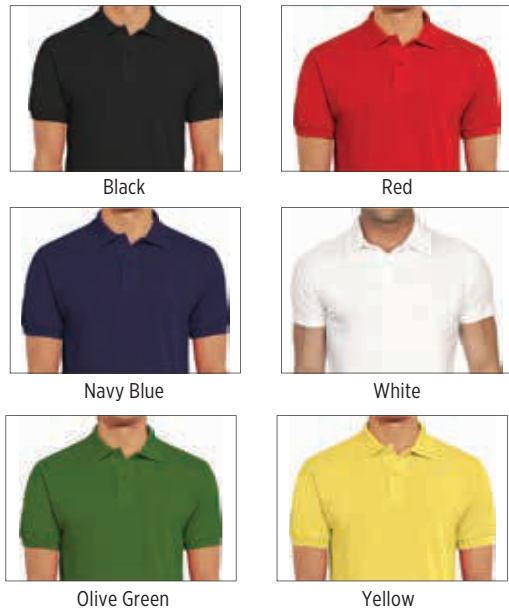

Black

Red

Navy Blue

White

Olive Green

Yellow



2 ply ring special yarn ensure lasting feel & Performance

READY STOCK

Item: Macy | GSM : 260/265 | Content : 100% cotton. 2ply premium super combed yarn | Measurement : Gulf | Sizes Available : S, M, L, XL, XXL - Black, Navy Blue, Red, L, XL, XXL - Olive Green, Yellow, White



100% cotton. 260 GSM 2 ply super combed pique polo shirt.

Premium quality comparable to top brands.

Performance for colour fastness, shrinkage and shape retention - wash after wash.

Well knit collar and cuff for stability, smart buttons, side slits for added comfort.



Print Technique :

- 1 Screen Printing
- 2 Heat Transfer
- 3 Embroidery

Preferred Print Location : Max Print Size:  
Left Chest Area / Sleeve 80 x 50 mm

Care Instructions:



Packing:

56 x 34x 39 cms ; 50 pcs /carton ; gw/nw: 20kg / carton  
\* Packing details may have ± 10% variation based on size breakup



Trendy embossed buttons

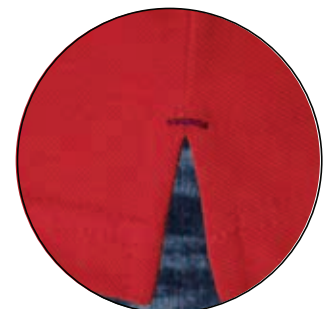

Side slits with bartack

\* Printing Limitations prevent exact fabric and color representation. The shades in the lots may differ due to lot-to-lot variations. The difference is no more than internationally accepted norms of the garment trade.



# DRYNCOOL EXCLUSIVE QUALITY POLO SHIRTS



Colours in Ready Stock



White



Black

READY STOCK

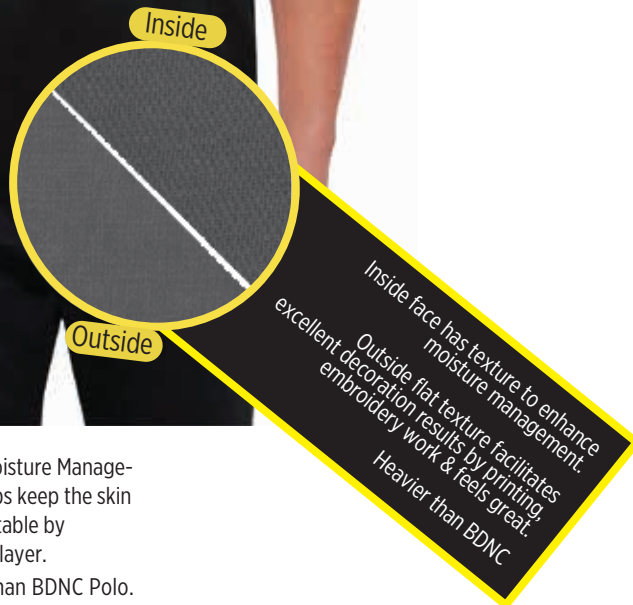

Dryncool is an advanced Moisture Management system (MMS) that helps keep the skin cooler & drier- more comfortable by transporting sweat to outer layer.  
Premium Quality Heavier than BDNC Polo.  
No fuss Performance.  
Creaseless.  
Contrast tape on button placket. Contrast neck tape highlighting the style.  
Authentic MMS logo

Item: EDNC | Content: Dryncool fabric  
Measurement: Europe | Sizes Available: S, M

### Print Technique :

- 1 Screen Printing
- 2 Heat Transfer
- 3 Embroidery

Preferred Print Location :

Left Chest Area / Sleeve

Max Print Size:

80 x 50 mm

### Care Instructions:



### Packing:



52.5 x 32.5 x 42.5 cms ; 50 pcs /carton ; gw/nw: 18kg / carton  
\* Packing details may have ± 10% variation based on size breakup

\* Printing Limitations prevent exact fabric and color representation.  
The shades in the lots may differ due to lot-to-lot variations.  
The difference is not more than internationally accepted norms of the garments trade.

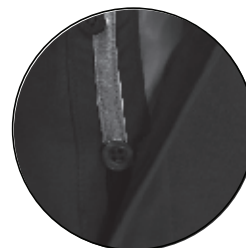

Contrast flat piping on inside placket



Side slits with contrast, bartack



Contrast piping on shoulder & cuff

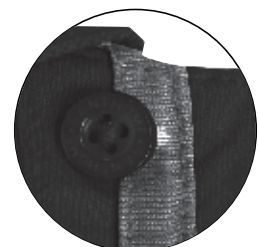

Trendy embossed buttons





**Ace Jacquard Polo with Bamboo**

2 Tone fabric of 65% polyester and 35% rayon nanobon. 2 Button placket with embossed buttons. 1 x 1 flat knit rib collar. Necktape. Slide slits/ PGA tour print at the sleeve.

Sizes: S, M

Print Technique : Sc, HT, Embroidery Preferred Print Location : Left Chest Area / Sleeve Max Print Size: 80 x 50 mm

Packing Details : 58 x 35 x 24cm; 40 pcs/carton; gw/nw: 12.5 kg/carton

\* Packing details may have ± 10% variation based on size breakup

READY STOCK



Red



Colours in Ready Stock \*

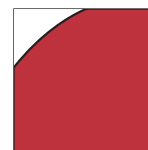

Red



Black

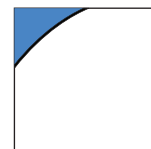

White

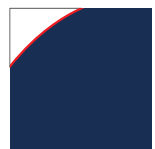

Navy

Pique knit of 100% combed cotton. GSM: 200-220. Reglan sleeves. 1 x 1 Flat knit rib collar. Contrast coloured piping on reglan sleeves. 2 Button placket with engraved tone on tone buttons. Self fabric necktape. Slazenger embroidery on backside. Embroidered main label at inside halfmoon.

Compliance : AZO, Formaldehyde, PCP, Uses non-carcinogenic dyestuff, APEO.

Sizes: Red - S, M, L, XL, XXL

Black, White, Navy - S, M

Print Technique : Sc, HT, Embroidery Preferred Print Location : Left Chest Area / Sleeve Max Print Size: 80 x 50 mm

Packing Details : 51 x 32 x 27cm; 30 pcs/carton; gw/nw: 9.5 kg/carton

\* Packing details may have ± 10% variation based on size breakup



White



Grey

100% Cotton long sleeve shirt with DuPont Teflon fabric protector. Breathable, Durable, Safe, Gentle fabric with Oil repellance & Stain resistance by *Tonino Lamborghini*

Print Technique : SC, HT, EMBROIDERY Preferred Print Location : Left Chest Area / Sleeve Max Print Size: 80 x 50 mm

Packing Details : 56.5 x 34x 42.5 cm ; 50 pcs /carton ; gw/nw: 19.2kg / carton Size: XS - XL

\* Packing details may have ± 10% variation based on size breakup

READY STOCK



Cream

Black

Navy Blue

Polo Shirts- 100% cotton short sleeve by *Tonino Lamborghini*

Print Technique : SC, HT, EMBROIDERY Preferred Print Location : Left Chest Area / Sleeve Max Print Size: 80 x 50 mm

Packing Details : 48 x 33x 42.5 cm ; 40 pcs /carton ; gw/nw: 16.4kg / carton Size: M, L, XL

\* Packing details may have ± 10% variation based on size breakup



**GIORDANO  
EASY CARE  
SHIRTS**

- Regular Fit
- Antibacterial  
This item has been treated with antibacterial properties, helping it stay fresh against common bacteria, such as Golden Staph, E. Coli and Candida Albicans.
- Easy iron
- 100% Cotton Oxford Fabric  
It offers superior hand feel.
- Button Down Collar, with patch pocket at chest
- Shirt designed as formal with comfort anytime & anywhere
- Wrinkle Free treated to avoid crinkles and keeps it fresh
- Mechanical stretch imparted on fabric to suit the body

**READY STOCK**

**Available in Short Sleeve & Long Sleeve**



White

**100% COTTON  
AVAILABLE COLORS  
FOR FULL SLEEVE**



Blue



Grey



READY STOCK



Premium Cotton fabric with super hand feel and smoothness



### Colours in Ready Stock\*



White



Petrol



Black



Orange



Navy Blue



Ash melange



Red

Item : BIO 180 | GSM : 180 | Content : 100% cotton. Super combed with Bio - Enzyme | Measurement : Gulf | Sizes : S, M, L, XL, XXL, 3XL

This Premium cotton T shirt uses high quality LONG STAPLE cotton from Central India.

This ensures superior consistency of the yarn it is spun from. Resultant fabric knitted shows the rich handfeel and luxury of COTTON we love. BIO process adds further to the smooth and soft luxury one would never want to come out of...!

#### Print Technique :

- 1 Screen Printing
- 2 Heat Transfer
- 3 Embroidery

Preferred Print Location : Max Print Size:  
Left Chest Area / Sleeve 80 x 50 mm

#### Care Instructions:



#### Packing:



52x 32.5x 50 cm ; 100 pcs /carton ; gw/nw: 21.5kg / carton  
\* Packing details may have ± 10% variation based on size breakup

\* Printing Limitations prevent exact fabric and color representation. The shades in the lots may differ due to lot-to-lot variations. The difference is no more than internationally accepted norms of the garment trade.



Tagless main label

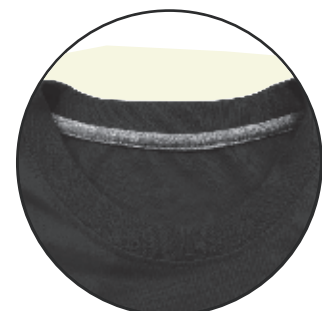

Contrast neck tape

READY STOCK

CORE365

by

SANTHOME



READY STOCK

# CORE365 ROUND NECK T-SHIRTS



Black



White



Red



Airforce Blue



Sky Blue



Jungle Green



Charcoal Grey

READY STOCK



Tagless Label

Item : CORE365 | GSM : 160 | Content : Blended Cotton.  
Measurement : Gulf Sizes Available : S, M, L, XL, XXL, 3XL

Feel the comfort with CORE365 - soft, blended cotton fabric t-shirt with a modern stretch classic fit. Maintains shape on washing

### Print Technique :

1 Screen Printing 2 Heat Transfer 3 Embroidery

Preferred Print Location : Left Chest Area / Sleeve

Max Print Size: 80 x 50 mm

### Care Instructions:



CORE365 is a premium soft, blended cotton fabrication t-shirt with a modern stretch fit. Feels soft on the body, maintains shape on washing, genuine stretch fitted and tag-free

**CLASSIC CREW**  
Perfect for layering

**GENUINE FIT**  
Moves freely with you

**TAG FREE**  
Prevents irritation

**CORE365**  
by  
SANTHOME

كور 365 تي شيرت كطني فاخر ، مصنوع من نسيج القطن الطبيعي الممزوج بتصميم عصري ، ناعمة على الجسم ، لا تتكسر عند الغسيل وتحتفظ بنفس الشكل ، تحتوي على نسيج مطاط اصلي وبدون رقع.

تي شيرت برقبة دائرية كلاسيك مثالية عند اللبس تحت القمصان

نسيج اصلي مريح تسمح بحرية الحركة

بدون رقعة لا تسبب الحساسية

**كور 365**  
من  
سانتوم



# T-SHIRTS

READY STOCK



Light weight, Special Knit fabric, with DrynCool Function

## SUBLIMATION

Supports Full Color Sublimation Printing

Item : ADS (ALLDAYSPORTS) | Content : Dryncool Sports fabric  
Measurement : Gulf | Sizes Available : S, M, L, XL, XXL, 3XL

### Print Technique :

- ① Screen Printing
- ② Heat Transfer
- ③ Embroidery
- ④ Sublimation

Preferred Print Location : Max Print Size:  
Left Chest Area / Sleeve 80 x 50 mm

### Care Instructions:



COMFORT KNIT

Item : SALAMA | Content : 100% Polyester  
Measurement : Gulf | Sizes Available : S, M, L, XL, XXL, 3XL

### Print Technique :

- ① Screen Printing
- ② Heat Transfer
- ③ Embroidery

Preferred Print Location : Max Print Size:  
Left Chest Area / Sleeve 80 x 50 mm

### Packing:



\* Packing details may have ± 10% variation based on size breakup



Red



Ink Blue



Black



### Care Instructions:



\* Printing Limitations prevent exact fabric and color representation. The shades in the lots may differ due to lot-to-lot variations. The difference is no more than internationally accepted norms of the garments trade.





Trendy Zippers and Draw Cords



Kangaroo Pockets.



Hoodie without zipper



Hoodie with zipper



READY STOCK

**Item:** SANTHOME ARTIK collection – Hoodies

**Content:** Cotton rich Soft single fleece.

**Measurement:** Gulf | **Sizes Available :** S, M, L, XL, XXL, XXXL

SANTHOME ARTIK Collection Hoodie Sweatshirts are made from high quality fleece. The inside is brushed which keeps you warm. The outer is plain and smooth. Contrasting Trims add to the elegance. Kangaroo pockets that keep your hands cozy. These hoodies are a perfect outdoor must have!

**Print Technique:** SC, HT, EMB    **Preferred Print Location :** (Zipper) Front Pocket    **Max Print Size:** 80 x 50 mm



**ADDO**

Addo hooded sweatshirt with full zipper. In combination of cotton and polyester materials of 280g/m2. With matching color cords and 2 front pockets. Available in sizes S, M, L, XL, XXL.

**Print Technique :** SC, EMB    **Preferred Print Location :** Front & Back    **Max Print Size :** 330 x 200 mm

**Packing Details :** 40 X 48 X 60 cms ; 20 kg Pcs: 25/ carton

\* Packing details may have +10% variation based on size breakup



# SANTHOME

- > 100% Acrylic
- > Cashmere Like
- > Sweater for winter, autumn & spring



### SANTHOME SWEATER

Print Technique : Embroidery Preferred Print Location : Left Chest Area  
 Max Print Size: 80 x 50 mm Size: M - XXL

- \* Printing Limitations prevent exact fabric and color representation. The shades in the lots may differ due to lot-to-lot variations. The difference is not more than internationally accepted norms of the garments trade.
- \* Packing details may have ± 10% variation based on size breakup

READY STOCK



Releases pressure off the ear when wearing mask !! Helps fight Covid-19



### HWHL 188 - KATHU

*Hans Larsen™* Heavy Brushed 6 Panel Classic cotton cap with button that allow you to put the mask straps around the buttons instead of your ears, a more comfortable way to wear face cover!

Print Technique : HT, SC, EMROIDERY Preferred Print Location : Front  
 Max Print Size : 80 x 30 mm

## Giftology



- > 100% Free Of Chemicals
- > UV Protection
- > Fast Cooling When Needed
- > In Easy To Bring Bottle With Carabiner

### WNGL 167 - LEBUS

*Giftology* Lebus is a Microfibre cooling towel 100% free of chemicals. 98% sun blocking function up to UV 50+ protection. The towel can be easily used by adding some cold water to the bottle creating a cool towel for fast refreshment. The bottle is made out of PP with ABS top and carabiner to take along on outdoor activities. Registered design®

Print Technique : UV, SC, EMBROIDERY Preferred Print Location : Bottle  
 Max Print Size : 190 x 45 mm Product Size : 17.5 x 7x 6 cm (Bottle)  
 Packing Details : 74 X 40 X 40 cm; 100 pcs/carton; gw/nw: 16 kg/carton



# SANTHOME

'de Genève'



These exclusive quality caps carry this **SANTHOME** logo 'de Genève'



White/Red



White/Pink



White/Maroon



SC 101 **SANTHOME** Performance / Sports Caps

Print Technique : HT, SC, EMBROIDERY Preferred Print Location : Front  
Packing Details : 54 x 44 x 44 cm; 144 pcs/carton; gw/nw: 11 kg/carton

Max Print Size: 80 x 30 mm

\* Packing details may have + 10% variation based on size breakup

# SANTHOME

## SANTHOME Deluxe pique mesh spandex fitted cap



White/White sandwich



Navy blue/White sandwich



Red/Black sandwich



Black/White sandwich

- One Size Fits All
- Excellent Shape Retention Even After Multiple Uses
- Contrast Color Sandwich On Front
- Fabric With Pores For Air Ventilation

SC 105

Santhome Nu-Fit® Performance Caps are a premium quality 6-panel constructed pique mesh spandex fitted cap, utilizing the patented Stretch-Fitting technology from Nu-Fit®. Stretch fitting by Nu-Fit® has excellent shape retention even after multiple uses and one size fits all. The pique mesh knit provides air ventilation, and spandex provides sweat absorption. Contains contrast sandwich. Santhome Nu-Fit® Performance Caps are an excellent premium cap / sports cap / outdoors / baseball cap.

Print Technique : HT, Embroidery Preferred Print Location : Front / Back Max Print Size: 45 x 35 mm

Packing Details : 62x 36 x 56 cms ; 150 pcs /carton ; gw/nw: 16.5 kg / carton

READY STOCK



# CAPS 100% COTTON - KIDS & ADULT



Red

Blue

White

DELANO

SCMK 101- White SCMK 102- Red SCMK 103- Blue

5 panel kid cap in bright colors. In 100% cotton material, with embroidered ventilation holes and adjustable velcro closure.

Print Technique : SC,EMB Preferred Print Location : Front Max Print Size : 80 x 45 mm

Packing Details : 64 X 40 X 44 cm ; 15 kg Pcs: 300/ carton

READY STOCK



White with Black sandwich



Pink with Purple sandwich



White with Royal Blue sandwich



Black with Grey sandwich



Maroon



100% Heavy brushed cotton cap with metal buckle

The best quality caps carry this *Hans Larsen* logo

Print Technique : HT, SC, EMBROIDERY

Preferred Print Location : Front

Packing Details : 72 x 45 x 39cm; 200 pcs/carton; gw/nw: 19 kg/carton



**IMPACT**  
100% Fully Recycled

387L

**READY STOCK**

Navy Blue

White

Black

**SAY NO TO GREENWASHING**

*Tell the true story of sustainability with genuine recycled rPET and cotton with validated claims.*

Certified by Global Recycled Standard

**GIFTS THAT GIVE BACK**

785 million people - 1 in 9 - lack access to safe water. We are supporting Water.org to change this.

For each IMPACT cap sold, 2% of sales is donated by the Xindao B.V. (Netherlands) to Water.org to save lives with safe water and sanitation.

water.org

**IMPACT**

**READY STOCK**

- > 2% of sales proceeds of each product committed to Water.org
- > Made of 100% recycled materials

- > Made with AWARE™ tracer
- > This cap saved 387 litres of water

**Ready Stock of these 4 colors in Europe**



280 gr Recycled Cotton Cap with Aware Tracker - XD Impact Collection

HWAW 451 - Black HWAW 452 - White HWAW 453 - Navy Blue

**XD COLLECTION** No greenwashing, but telling a true story about sustainability! This Impact collection is made with AWARE™ tracer. With AWARE™, the use of genuine recycled fabric materials and water reduction impact claims are guaranteed by using the AWARE disruptive physical tracer and blockchain technology. Save water and use genuine recycled fabrics. With the focus on water 2% of proceeds of sold Impact product has been donated to Water.org. This cap has saved 387 litres of water. A simple and comfortable cap suited for anyone. This 6 panel cap has a curved visor, embroidered eyelets for ventilation and metal buckle. Cotton twill made of 100% recycled materials and AWARE™ tracer. The material weight is 280 g/m2. Size 58cm.

Print Technique : HT, SC, EMBROIDERY  
Product Size: 58 cm

Preferred Print Location : Front  
Packing Details : 36.5 X 45.5 X 69.5 cms ; 200 pcs / carton ; gw / nw : 17 kg / carton

Max Print Size : 45 x 35 mm



# CUSTOMISED APPAREL

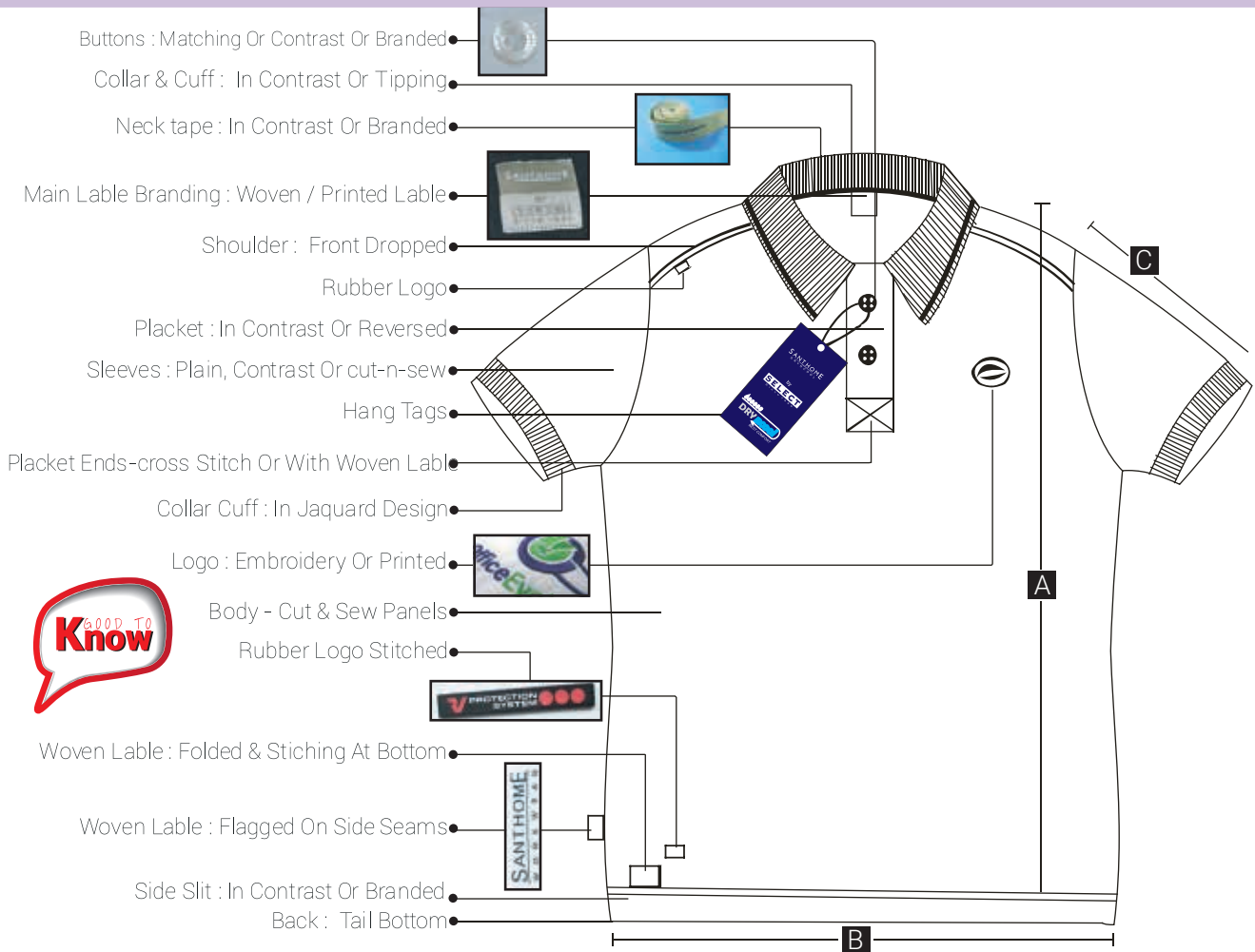

## Typical measurements:-

	Gulf/Asian Sizes			Europe Sizes		
	M	L	XL	M	L	XL
A	28	29	30	29	30	31
B	21	22	23	22	23	24
C	8	8.5	9	8.5	9	9.5

These measurements are for guidelines only. The actual measurements may vary slightly between garments as knit garments have internationally accepted higher tolerance values

## GSM or GMS ?

Most manufacturers confuse clients with this. GSM: Grammes per sq. meter is the wt. of the fabric in a square of 1 meter x 1 meter.it remains the same in all sizes. Hence the correct way to describe GMS: is the wt. in grammes per piece of the Tee/Polo And will always vary with each size. Thus, completely misleading. We ALWAYS specify the GSM. So you are rest assured of what we offer.

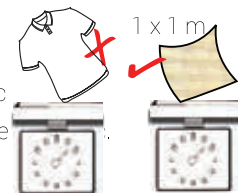

## Heavier the better ?

Not necessarily. The quality of yarn will decide the quality and Price. Super combed, combed, semi combed and carded: this is the quality of YARN in descending order. We specify the yarn. So you are rest assured of what we offer.

## What more we can offer:

You Are Welcome To Send Your Design Ideas And Originals. We Will Reproduce It For You..!



**BELAND**



**VECCHIA**



**INBICTA**

Various Trendy styles can be created with decoration by print and embroidery. Your special design can be created as per demand.

Fabric suggestions : 100 % Cotton, Polymesh, Dryncool, ADF etc.

Pantone matching items can be produced against MOQ requirements.

The brands & images used are for representation purpose only & belong to their respective brand owners.

**CUSTOM MADE**

## CUSTOMIZED WINTER JACKETS



Brocky Jacket  
in Tetron



100% heavy polyester soft micro jacket with multiple zipper pockets and snap button opening. Long jackets. Lined with heavy fleece. Subtle contrasts make it trendy and functional.



100% cotton twill reporter jacket with various pockets for multiple use.

The brands & images used are for representation purpose only & belong to their respective brand owners.



# CUSTOMIZED ACTIVE WEAR



Polymesh Track set for ladies with lining of cotton jersey

CUSTOM MADE



WROCLAW



BUKINI

Bukini using stretch material

The brands & images used are for representation purpose only & belong to their respective brand owners.



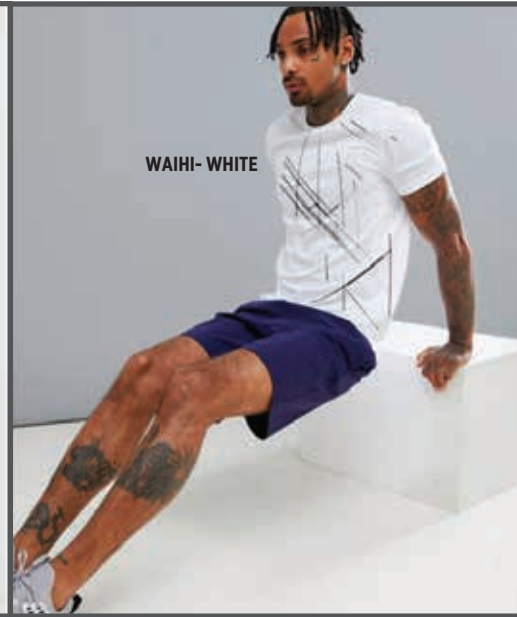

CUSTOM MADE

Amazing trendy sportswear of high quality can be produced using ADF, Polymesh or special materials. Branding by special quality printing is also possible against MOQ requirements.

The brands & images used are for representation purpose only & belong to their respective brand owners.



CUSTOM MADE



SANTHOME WORKWEAR are customized for workshops and showrooms as smart outfits meeting exacting standards of quality and performance. # Kameer has provision for knee pads for extra protection at work. 100% cotton or polycot fabric will meet client requirements of comfort and utility.

The brands & images used are for representation purpose only & belong to their respective brand owners.



Formal shirts and trousers in various colours, fabric qualities. Designs can be made customized to the need of the industry. Shirts come in plains and oxfords. Trousers come in PV, PC and cotton.



Men's Solid shirt



Oxford Ladies Shirt

Formal modern fit PV pleated trousers

CUSTOM MADE



HILTON CARGO PANT

BEWEAR Shirt in 100% cotton twill has excellent resilience to everyday wash and wear. Two patch pockets with button through flaps on front and a pen slot on sleeves. Ideal for driver sandas Security uniforms. Co-ordinated HILTON cargo Pants in 100% cotton Chinos are a smart uniform for staff.



KORAM

KORAM Messenger Uniforms Set: Polycot Multipanel shirt with black Polycot trousers. Smart uniforms that will also delivery our identity!

The brands & images used are for representation purpose only & belong to their respective brand owners.



# T-SHIRTS



CUSTOM MADE



Royal Blue



Orange



Sky Blue



Navy Blue



E-Green



B-Green



Red



Pink



White



Black



Grey Melange



Yellow



Beige



Maroon

Item: SELECT 180 | GSM: 180 gsm | Content : 100% COTTON

Sizes Available : S, M, L, XL, XXL

Regular round neck t-shirts for mass distribution

Print Technique : SC, HT, EMB Preferred Print Location : Left Chest Area Sleeve Max Print Size : 80 x 50mm

Packing Details : 58 x 38 x 35cm; 100 pcs/carton; gw/nw: 21.5kg/carton

\* Printing Limitations prevent exact fabric and color representation.

The shades in the lots may differ due to lot-to-lot variations.

The difference is not more than internationally accepted norms of the garments trade.

\* Packing details may have ± 10% variation based on size breakup

SAILOR COTTON  
POLO SHIRTS



SAILOR



White



Cream



Yellow



Red



Navy Blue



Grey Melange



Sky Blue



Orange



B-Green



Black



Ash Melange



Royal Blue

CUSTOM MADE



E-Green



Maroon

Item : SAILOR POLO | GSM : 220 gsm | Content : 100 % cotton  
 Sizes Available: S, M, L, XL, XXL

Regular pique polo for mass distribution

Print Technique :

- 1 Screen Printing
- 2 Heat Transfer
- 3 Embroidery

Preferred Print Location : Max Print Size:  
 Left Chest Area / Sleeve 80 x 50 mm

Care Instructions:



Packing:

58x 29x 40cm; 50pcs/carton; gw/nw: 22kg/carton  
 \*Packing details may have ± 10% variation based on size breakup



\* Printing Limitations prevent exact fabric and color representation.  
 The shades in the lots may differ due to lot-to-lot variations.  
 The difference is no more than internationally accepted norms of the garments trade.



SAFE  
SIMPLE  
SWISS

Scan Below QR  
code to watch  
Brand video



### SKROSS® – Swiss innovation

SKROSS® invented and patented the first all-in-one world adapter with country slider system in 2002.

### Using international standards as the basis for product development

At SKROSS®, **safety** is always at the centre of the entire development and production process. The standards defined by the International Electrotechnical Commission (IEC) form the foundation for the development team to design innovative gadgets that give you access to power anywhere in the world. Extensive quality controls accompany every production phase, with final certification processes documenting each product's compliance with IEC standards.

### Simple charging – any time

The patented country slider system ensures connection in over 150 countries.

Scan Below QR  
code to watch  
product video



READY STOCK

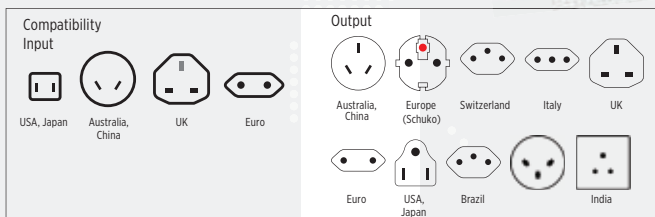

- Designed In Switzerland
- Suitable For All 2-pole (Unearthed) Devices
- Receptacles For: Euro, USA/Japan, Australia/China, UK
- Retractable Plugs: Euro, USA/Japan, Australia/China, UK
- Dual USB Top For Charging USB Devices Output 5V / 2.1A Shared
- Input Voltage: 100V – 250V ; Max. Load: 2.5A
- Power Rating: E.g. 100V – 250W / 250V – 625W
- Integrated Fuse: T2.5A

### TASK 101 - SKROSS WORLD ADAPTER MUV MICRO USB

The World Adapter MUV Micro from SKROSS with dual USB charging functionality is the most compact 2-pole travel adapter for travellers from all over the world. The patented country slider system guarantees simple and safe connection in over 150 countries on all continents – irrespective of the socket standard.

Product Size : 7.4 x 5 x 5.3 cm    Packing Details : 34.5 X 29.5 X 18.5 cm ; 50 pcs / carton ; gw / nw : 8.66 kg / carton



Scan Below QR code to watch product video



@MEMORI

- > Type-C Input
- > World Travel Adapter With 5000 mAh Powerbank
- > Includes US/EU/UK/AUS Plugs
- > High Density Li-Polymer Battery
- > Travel Adapter With 2 USB Outputs



ITTA 1120 - BRUSY

@MEMORI Brusy is a Universal World Travel Adapter with a detachable 5000mAh Powerbank. The adapter has 2 USB outputs to charge 2 devices simultaneously & is compatible with over 150 countries with US/EU/UK/ AUS plugs. Just push the knob of the plug you want to charge & your device will charge safely in almost any part of the world. Attached to the Universal travel adapter is a 5000mAh detachable Powerbank which is equipped with high density Li-Polymer battery that safely charges almost any of your electronic devices very quickly. Input /Output : 5V/2A.

Print Technique : UV Preferred Print Location : Front Max Print Size : 70 X 40 mm  
 Product Size : 9 x 5.5 x 5.5 cm Packing Details : 61.7 x 23.7 x 8.1 cm ; 14pc /carton; gw/nw: 4.90 kg / carton

READY STOCK



- > Weight Mode : Kg/lb
- > Weight Range : 300 Gms - 40 Kgs
- > Tare Function And Data Lock
- > Overload Indicator

ITTA 301 - FANO

Giftology Digital luggage scale with max capacity of 40kg, division 100g, kg/lb mode, zero and tare function, low battery and overload function.

Print Technique : SC, UV Preferred Print Location : Front Max Print Size : 20 x 15 mm  
 Product Size : 11.7 X 3.9 X 2.70 cm Packing Details : 31.5 x 25.5 x 27.5 cm; 60 pcs/carton; gw/nw: 4.6 kg/carton



- > UV-C Kills 99.9% bacteria
- > 2 different zippered compartments, for UV-C & for holding travel & daily accessories
- > Sterilise on - the - go
- > Use your own powerbank / power source or check with us for our range of powerbanks ( Pages 94 to 100 )
- > Non - Toxic; Without Mercury



**ITSN 104 - HABRY**

**SANTHOME PROTECT** Everyday use pouch that keeps your daily articles SAFE and HYGIENIC. This pouch has a special compartment with UV-C light that kills 99.9% bacteria on the item kept in the compartment. This UV-C compartment can help you with sterilizing your currency, passport, boarding pass, phone etc that are generally prone to multiple contact with bacterial surfaces by just connecting a cable provided on the back pocket to a power source such as laptop or powerbank. Another zipper compartment features- a zipper pocket for keys, currency, coins etc., pocket to hold multiple passports and has space for your everyday electronic accessories. Packed in a Santhome gift box.

Print Technique : SC, HT Preferred Print Location : Front Bottom Max Print Size : 75 X 70 mm  
Product Size : 21.5 X 13 X 4.5 cm Packing Details : 45.7x 31.5 x 48.4 cm ; 28 pcs / carton ; gw / nw : 13.2/14.2 kg / carton

READY STOCK



- > UV-C Kills 99.9% bacteria
- > External Material is Anti-Microbial
- > Sterilise on - the - go
- > Use your own powerbank / power source or check with us for our range of powerbanks ( Pages 79 to 94 )
- > Non - Toxic; Without Mercury



**ITSN 102 - VADUZ**

**SANTHOME PROTECT** UV-C steriliser pouch that kills up to 99.9% of the bacteria on the item kept inside the pouch. Place objects like phone, earbuds, jewellery, watches and facemask inside the pouch and connect to a charging source such as a laptop or powerbank (for up to 5 min) to 100% sterilise them using UV-C technology. The external material of the pouch is treated with Antimicrobial agents for extra safety. The 2 UV-C LED light inside is non-toxic and made without mercury (beware of many UV lamps in the market) The lights have a lifecycle of 10,000 hours.

Print Technique : SC Preferred Print Location : Front Pocket Max Print Size : 75 X 70 mm  
Product Size : 20 X 11.5 X 3 cm Packing Details : 44 x 47 x 28 cm ; 40 pcs / carton ; gw / nw : 9.74 kg / carton





- Compatible with all wireless charging smartphones due to included magnetic ring
- Made with powerful N52 magnets
- Multi-tasking and productivity enhancements possible
- 15W Fast Wireless Charging while phone is mounted

READY STOCK

**ITGS 1115 - DABIE**

@MEMORii This 2-in-1 kit consisting of a metal phone or tablet mount for your laptop and a matching 15W universal magnetic wireless charger that can charge any wireless compatible smartphone, while it is mounted alongside your laptop. Both items are made from CNC polished aluminum with N52 magnets inside. The universal magnetic wireless charger comes with an extra magnetic ring that can be attached to any wireless charging smartphone, effectively converting them into a magnetic charging compatible device. You can now benefit from hands-free phone/tablet accessibility, convenient use of dual screens and fast universal wireless charging - all at the same time. This kit will help boost your productivity while working, studying, or on the go.

Print Technique : UV, SC, ENG    Max Print Size : 65 X 23 mm or ø32 mm    Preferred Print Location : Back  
 Product Size : 12.5 x 3.5 x 0.6 cm



## MANICURE / GROOMING SET



### GSMS 9105 - CHELLES

CHELLES Manicure Set is a world leading quality manicure / grooming set by THREE SEVEN with 7 gold plated instruments, including nail clipper, tweezer, diagonal clipper, beauty scissors, file, V-shaped push stick and ear pick. Made in Korea.

Print Technique : UV, SC Preferred Print Location : Front Max Print Size : 85 X 72 mm

Product Size : 10.2 x 7.7 x 1.7 cm

READY STOCK



### GSMS 9106 - GLINA

GLINA Manicure Set is a world leading quality manicure / grooming set by THREE SEVEN with 4 chrome plated instruments, including nail clipper, tweezer, beauty scissors, file. Made in Korea.

Print Technique : UV, SC Preferred Print Location : Front Max Print Size : 110 X 54 mm

Product Size : 12 x 4.6 x 2.2 cm

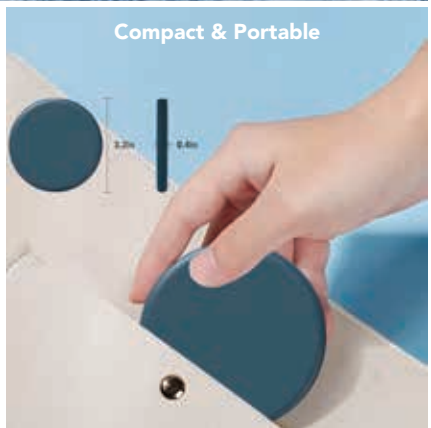
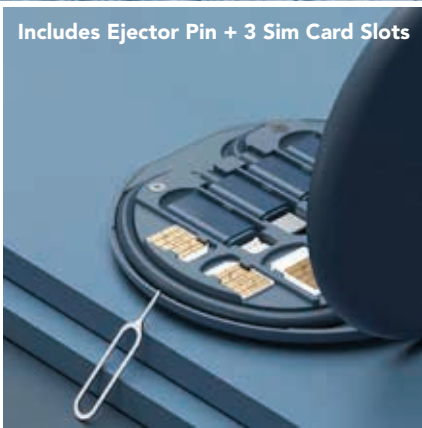

READY STOCK

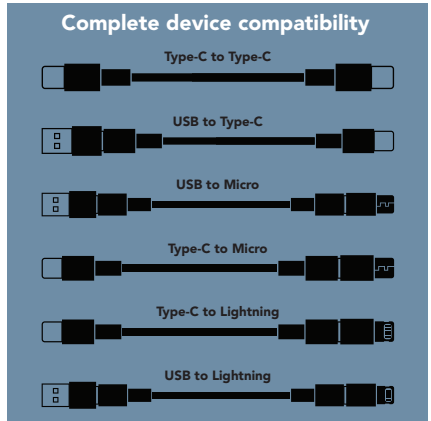
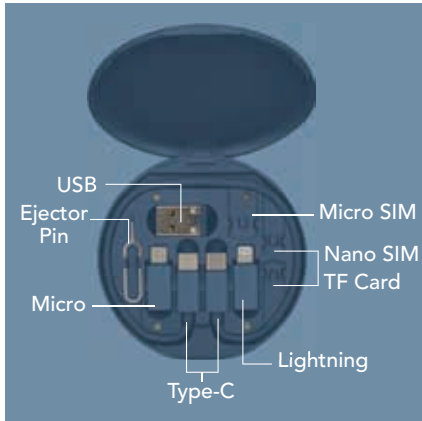

- Sleek Travel-Friendly Cable Case
- Made from Recycled Claim Standard (RCS) Plastic, certified by Intertek
- Magnetic Closing
- Convenient Mobile Holder attachment

TAVIRA

MTST 1126 - Black MTST 1127 - White MTST 1128 - Blue

@MEMORii Multi-cable set with charging cables for all your essential connections: Type C, Lightning, micro USB and USB. Also comes with storage space for ejector pin and 3 slots of micro SIM, nano SIM and TF SIM cards. Tavira is made from RCS-certified recycled plastic and carries all your essential technology accessories in a compact travel size case. It can also serve as a phone or tablet stand for added on-the-go convenience. A great giveaway idea for your customers to remember you by!

Print Technique : SC, UV  
Product Size : ø8.4 x 1 cm

Max Print Size : ø75 mm

Preferred Print Location : Top



READY STOCK

RFID BLOCKING



- > RFID Safe
- > Lightweight & Ultrathin Material
- > Passport Holder + Wallet Set

GSXD 101 - QUEBEC SET

XDXCLUSIVE® This set consists of lightweight and secure RFID safe bi-fold wallet and passport holder. The RFID-blocking material protects against identity theft & electronic pick pocketing. Registered design®

(Passport Holder) Print Technique : SC, EMB, ENG

(Wallet ) Print Technique : SC, EMB, ENG

Product Box Size : 22 X 2 X 16.8 cm

Preferred Print Location : Front

Max Print Size : 70 x 60 mm

Preferred Print Location : Front

Max Print Size : 80x 40 mm

Packing Details : 41 x 36 x 14cm ; 80pcs /carton; gw/nw: 4.2 kg / carton



High Quality

Regal Velvet Carry Pouch

### PMSN 9103 - SAJADA

The faithfuls concentrate on their prayer and spiritual connection. Sajada mat provides a comfortable experience to make it easier to focus. Folding into an elegant velvet pouch, the Sajada mat is made with natural rubber with soft suede finish and is purpose-built for all situations-use it at home, outside and during travel. Designed to help a seeker with their inward journey.

Print Technique : SC

Preferred Print Location : Front & Back of Pouch

Max Print Size : 220 x 160 mm

Product Size: 107 X 68 cm

READY STOCK



High Quality

Regal Velvet Carry Pouch

### PMSN 9104 - SAJADA

The faithfuls concentrate on their prayer and spiritual connection. Sajada mat provides a comfortable experience to make it easier to focus. Folding into an elegant velvet pouch, the Sajada mat is made with natural rubber with soft suede finish and is purpose-built for all situations-use it at home, outside and during travel. Designed to help a seeker with their inward journey.

Print Technique : SC

Preferred Print Location : Front & Back of Pouch

Max Print Size : 220 x 160 mm

Product Size: 107 X 68 cm



# TRAVEL ACCESSORIES



SANTHOME

- > Set Consisting Of Neck Pillow & Eye Mask
- > Foldable Design For Easy & Compact Carry
- > Comfort Lifestyle Product



TASN 101- ZABARI

SANTHOME Prevent neck, shoulder and head complaints with this microbead neck pillow. The U-shape of this super soft neck pillow guarantees optimal support for your neck, shoulders and head during long or short trips. Also included is an eye mask for a good sleep. Neck Pillow & Eye Mask fold inside a compact, easy to carry pouch.

Print Technique : SC, UV Preferred Print Location : Pouch Max Print Size : 70 x 90 mm  
Product Size : 15 x ø16 cm Packing Details : 34 x 46 x 45 cm ; 24 pcs /carton ; gw/nw: 8.9 kg / carton

READY STOCK



SWISS PEAK®



Designed by:



Ryan McSorley  
Ireland

TA 120 - ALPINE

SWISS PEAK® 1680D zippered travel wallet with metal Swiss Peak logo on the front. All pockets required for a comfortable and practical journey are present there. Furthermore integrated cord allows easy hanging of the wallet around your neck. Registered Design®

Print Technique : SC, ENG Preferred Print Location : Center Max Print Size : 60 x 60mm  
Product Size : 14.5 x16.5 x 3 cm Packing Details : 35 x 30.5 x 41 cm ; 50 pcs /carton ; gw/nw: 13.5 kg / carton



Giftology



Packed in a Cotton Pouch



- > Genuine Leather
- > Toiletries Pouch / Wash bag for organizing your travel
- > Zipper Pockets in front, at the back & on top
- > Spacious interior

LAGL 019 - GUBEN

Giftology Each leather wash bag in an elegant natural cotton drawstring pouch.

Print Technique : FO, EMB, SC Preferred Print Location : Front Max Print Size : 40 X 50 mm  
Product size : 25 X 10 X 13 cm



- > High end - Sustainable Travel accessory
- > Made from GRS-Certified Recycled Fabric
- > This Bag saved 10 litres of water
- > This Bag is made by recycling 4 plastic bottles

**HPSN 551 - TRIKOMO**

SANTHOME CHANGE Wash Bag / Toiletries Pouch - made with high-end durable 1680D recycled rPET (certified by GRS) and stylish leather components. Get your essentials organized while supporting Water.org to provide safe water to people in need with each purchase. Each bag saves 10L of water and reuses 4 plastic bottles

Print Technique : SC Preferred Print Location : Front Max Print Size : 110 x 50 mm

Product size : 23 X 14 X 10.5 cm

**SAY NO TO GREENWASHING**

*Tell the true story of sustainability with genuine recycled rPET*

**Certified by**



**GIFTS THAT GIVE BACK**

785 million people - 1 in 9 - lack access to safe water. We are supporting Water.org to change this.

For each CHANGE bag sold, **3% of sales is donated** by Jasani L.L.C. to Water.org to save lives with safe water and sanitation.



**READY STOCK**



- > High end - Sustainable Travel accessory
- > Made from GRS-Certified Recycled Fabric
- > This Bag saved 9 litres of water
- > This Bag is made by recycling 4 plastic bottles



**HPSN 552 - POMOS**

SANTHOME CHANGE Technology Accessories Kit - made with high-end durable 1680D recycled rPET (certified by GRS) and stylish leather components. Organizes all tech accessories (like cables, chargers, power banks, adapters, etc.). Great for office or travel. Each bag saves 9L of water and reuses 4 plastic bottles, while supporting Water.org to provide safe water to people in need with each purchase.

Print Technique : SC

Preferred Print Location : Front

Max Print Size : 120 x 100 mm

Product size : 27 X 16 X 7 cm



# PREMIUM CABIN TROLLEY & TRAVEL GARMENT BAG

## SANTHOME



TSA Lock For Compartments



Quick Access Front Pocket



Scan Below QR code to watch product video



- > 20" Cabin Trolley With 17" Laptop Compartment
- > External USB Charging Port
- > Twin TSA Lock For Both Main Compartment & Front Pocket
- > Quick Access Front Pocket
- > Sturdy Double Spin Wheels

### TBSN 104- CASHEL

SANTHOME Cashel is a 20" Overnighter trolley bag with Iron Trolley System, Double Spin wheels, Dual TSA lock (one for main compartment and second for the front pocket), USB external charging port on the outside and a laptop compartment. Now go on your business trips in style and comfort with this lavish looking trolley bag.

Print Technique : SC

Preferred Print Location : Front flap

Max Print Size : 100 X 40 mm

Product Size : 55 X 35 X 23.50 cm

Packing Details : 57.5 x 37 x 23 cm ; 1 pcs /carton ; gw/nw: 3.66 kg / carton

READY STOCK



### MARTONE -98185

Conino Lamborghini An easier way to arrive fresh and pressed. Lightweight and fully stocked with multiple organizational features, this garment bag uses a locking hanger clamp system that keeps clothes wrinkle free and is built with handles that fasten together for even easier carrier.

Print Technique : SC, HT

Preferred Print Location : Front

Max Print Size : 100 x 30 mm

Product Size : 52 x 38 x 16 cm

Packing Details : 57.2 x 40.3 x 57.8 cm ; 6 pcs /carton ; gw/nw: 12.8 kg / carton





- > 17" Laptop Compartment
- > Well Balanced 4 Wheel Trolley System
- > Perfect For Overnight Business Trips

**TBSN 103 - LAPOVO**

**SANTHOME** All your documents will pack securely in this business trolley. Papers and laptop(upto 17") can be neatly placed in one of the compartments, some of which can be locked. Also a perfect trolley for short business trips. With 4 wheel trolley system for stability on your way.

Print Technique : SC, HT

Preferred Print Location : Front flap

Max Print Size : 30 x 100 mm

Product Size : 44 x 43 x 23 cm

Packing Details : 60 X 44 X 43.5 cm ; 3 pcs / carton ; gw / nw : 9.4 kg / carton

READY STOCK



Santhome Zipper Pullers



- 
- 
- 
- 
- 
- 

**TBSN 101 - CARYONN**

**SANTHOME** 17", 4 wheel Trolley bag made from high quality and durable, dual tone cationic fabric. The luggage is designed to fit in most airlines overhead compartments. Foam center garment panels gently blanket clothes to minimize wrinkling. Compact, rugged and exceptionally manoeuvrable, this trolley has multiple exterior pockets to keep boarding passes, magazines and a water bottle close at hand. Four 360° spinner wheels and a three-stage aluminum handle let you glide through the airport and down the aisle without a hitch.

Print Technique : SC, HT

Preferred Print Location : Front Top

Max Print Size : 100 x 30 mm

Product Size : 43 x 36 x 20 cm

Packing Details : 72 x 43 x 40.5 cm ; 3 pcs / carton ; gw / nw : 11 kg / carton



READY STOCK





Grey



Black

**SAY NO TO GREENWASHING**

*Tell the true story of sustainability with genuine recycled rPET*

Certified by



**GIFTS THAT GIVE BACK**

785 million people - 1 in 9 - lack access to safe water. We are supporting Water.org to change this.

For each CHANGE product sold, 3% of sales is donated by the brand owners to Water.org to save lives with safe water and sanitation



READY STOCK



- Trendy 2-in-1 design for laptop sleeve and workstation
- Lifts laptops 6 cms for better work comfort
- Versatile pockets in the back
- Portable and easy to carry
- Uses high quality magnets for the cover and laptop stand



FULDA

LSSN 411 - Black LSSN 412 - Grey

SANTHOME Santhome Fulda - CHANGE Collection 15.6" Laptop Case & Workstation is a trendy and practical 2-in-1 laptop sleeve and workstation made from GRS-certified RPET and stylish faux leather. The laptop sleeve easily converts into a mobile office with laptop stand so you can work anywhere comfortably. Stay organised with the additional sleeve pockets and pen loops that allows you to take your other office essentials with you. Each recycled bag saves 2.5L of water, reuses 3 plastic bottles and makes an impact by contributing to Water.org - a global NGO that provides millions in need with access to safe water and sanitation. By giving to Water.org, you are giving a GIFT THAT GIVES BACK.

Print Technique : SC

Preferred Print Location : Front

Max Print Size : 120 x 100 mm

Product size : 27 X 16 X 7 cm

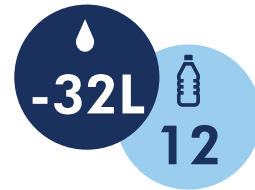

READY STOCK

- > Made from Recycled PET fabric certified by Global Recycled Standards
- > 3% of sales proceeds of each product is committed to Water.org
- > This bag saved 32 liters of water
- > Back trolley strap to attach backpack to trolley bag
- > This Bag is made by recycling 12 plastic bottles

**SAY NO TO GREENWASHING**

*Tell the true story of sustainability with genuine recycled rPET*

Certified by



**GIFTS THAT GIVE BACK**

- 💧 785 million people - 1 in 9 - lack access to safe water. We are supporting Water.org to change this.
- 💧 For each CHANGE bag sold, 3% of sales is donated by brand owners to Water.org to save lives with safe water and sanitation.



MBSN 972 - OIKOS

SANTHOME CHANGE Laptop Office Bag made from high-end durable 1680D recycled rPET (certified by GRS) and stylish leather components. Convenience pockets in the front for quick access of mobile phones, documents, etc. Each bag saves 32L of water, reuses 12 plastic bottles and makes an impact by supporting Water.org to provide safe water to people in need with each purchase.

Print Technique : SC Preferred Print Location : Front Max Print Size : 170 X 200 mm  
Product size : 38 x 28 x 7 cm Packing Details : 69 x 60 x 49 cm ; 6 pcs /carton ; gw/nw: 10.9 kg/ carton



- > Modern and elegant office faux leather briefcase
- > 15.6" padded laptop compartment
- > Stylish front pocket for easy access
- > Zippered back pocket



**MBSN 2102 - TRANAS**

SANTHOME Santhome® Tranas is modern elegance exemplified. Santhome® Tranas Premium Faux Leather Office Laptop Bag and Document Case with 15.6" padded laptop compartment, strong handles, stylish front pocket for easy access and a zippered back pocket.

Print Technique : UV, SC, ENG  
Product Size : 41 x 30 x 10 cm

Preferred Print Location : Below Zip

Max Print Size : 250 x 140 mm

READY STOCK



- > 15.6" Laptop Compartment
- > Light Weight For Daily Use
- > Trolley Strap On Back

**MBSN 808- KAVARNA**

SANTHOME Slim, compact case with large main compartment perfect to carry laptops upto 15.6" without making it bulky. Front zippered pocket for storage of other gear. Beautiful bold padded double handles. Back strap allows for the bag to be securely attached to a trolley.

Print Technique : SC, ENG  
Product Size : 38 x 7.5 x 30 cm

Preferred Print Location : Front

Max Print Size : 100 x 120 mm

Packing Details : 65 X 45 X 41cm ; 6 pcs /carton ; gw/nw: 8.60kg / carton



READY STOCK

- > Duo-tone fabric laptop bag
- > Holds up to 15" laptops
- > Sleek and fashion look



MBSN 2101 - GALDAR

SANTHOME Trendy duo-tone 15" laptop office bag made with duo-tone fabric and PU leather combination. Contains shoulder strap inside. Sleek look

Print Technique : SC Preferred Print Location : Front Max Print Size : 120 x 100 mm

Product Size: 38 x 29 x 6.5 cm



**SAY NO TO GREENWASHING**

*Tell the true story of sustainability with genuine recycled rPET and cotton with validated claims.*

Certified by Global Recycled Standard

**GIFTS THAT GIVE BACK**

💧 785 million people - 1 in 9 - lack access to safe water. We are supporting Water.org to change this.

💧 For each IMPACT bag sold, **2% of sales is donated** by the Xindao B.V. (Netherlands) to Water.org to save lives with safe water and sanitation.



**-15L** **26**

**READY STOCK**

- 2% of proceeds of each product donated to Water.org
- This bag is made of 26 recycled bottles
- Made with AWARE™ tracer
- This bag saved 15 liters of water

MBAW 461 - Black MBAW 462 - Navy Blue

**XD COLLECTION** No greenwashing, but telling a true story about sustainability! This Impact collection is made with AWARE™ tracer. With AWARE™, the use of genuine recycled fabric materials and water reduction impact claims are guaranteed, by using the AWARE disruptive physical tracer and blockchain technology. Save water and use genuine recycled fabrics. If you choose this item you save 15 litres of water and 26 plastic bottles have been reused. With the focus on water, 2% of proceeds of each Impact product sold is donated to Water.org. Casually professional and organised, the Impact 15.6" laptop bag is made for the modern professional with an eye for value and the environment. It features a classic design with front accent stitching, multiple storage pockets, two top handles, and an adjustable, detachable shoulder strap. The outer fabric and inner lining consist of 100% recycled polyester with AWARE™ tracer. PVC free.

Print Technique : SC Preferred Print Location : Front Max Print Size : 180 x 30 mm  
Product Size : 28 x 6 x 39.5 cm Packing Details : 49.5 X 38.5 X 48.5 cms ; 12 pcs / carton ; gw / nw : 5.5 kg / carton



BEST IN CLASS BY **SANTHOME**



**Features to note:**

- Create your work station anywhere
- Water-proof exterior coating
- Adjustable screen height up to 19 cm
- Shock resistant case to protect your laptop
- Admirable interior fabrics
- Quick-stash charger pocket
- Eye-level video conferencing
- Ergonomic Design

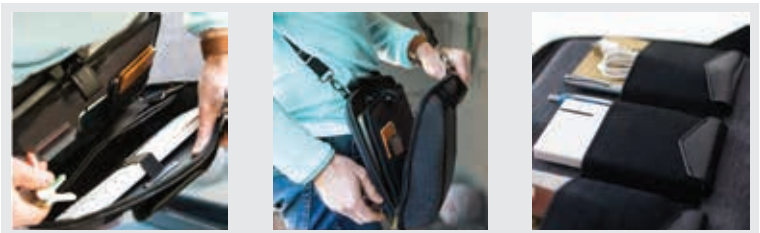

**READY STOCK**

**MBSN 810 - EVRY**

**XDDESIGN** Want to simply work on the go without hassle and have fast and easy pack up? Evry puts an end to the nasty neck pain laptops create and provides an incredible function that lets you view your laptop at your desired angle of view.

Print Technique : UV, ENG

Preferred Print Location : Plate

Max Print Size : 40 x 25 mm

Product size : 43 X 32 X 12 cm

Packing Details : 62 x 32 x 45 cm ; 5 pcs /carton ; gw/nw: 8.35 / 10 kg / carton



Scan Below QR code to watch product video



**MBSN 807- RONDE**

**SANTHOME** Ronde is a daily use messenger bag with Three-Dimensional Tailoring and made from water-resistant and wear resistant premium fabric. The main compartment can store upto 15.6 inch laptop and 11 inch tablet is designed with full open zipper to increase the practicability of storage. External USB output allows for your phone to be charged outside even when your powerbank is placed inside the bag. Mesh back pads and shoulder straps provide comfort and breathability.

Print Technique : SC

Preferred Print Location : Front

Max Print Size : 150 x 150 mm

Product Size : 40 x 11 x 31 cm

Packing Details : 57 X 35 X 44 cm ; 10pcs / carton ; gw / nw : 7.6 kg / carton



## CROSS - The Iconic Brand

The iconic writing instruments brand established in the United States in 1846. Famed as the brand used by American Presidents, Cross Leather Accessories have been extremely successful and the award-winning leather accessories collection is currently being retailed in over 40 countries across the globe. Over a short span, the leather accessories under CROSS's banner has managed to gather a lot of fame with two consecutive wins in Germany this year at the Red Dot Design Awards and ILM Offenbach Awards. CROSS products form an excellent gifting option.

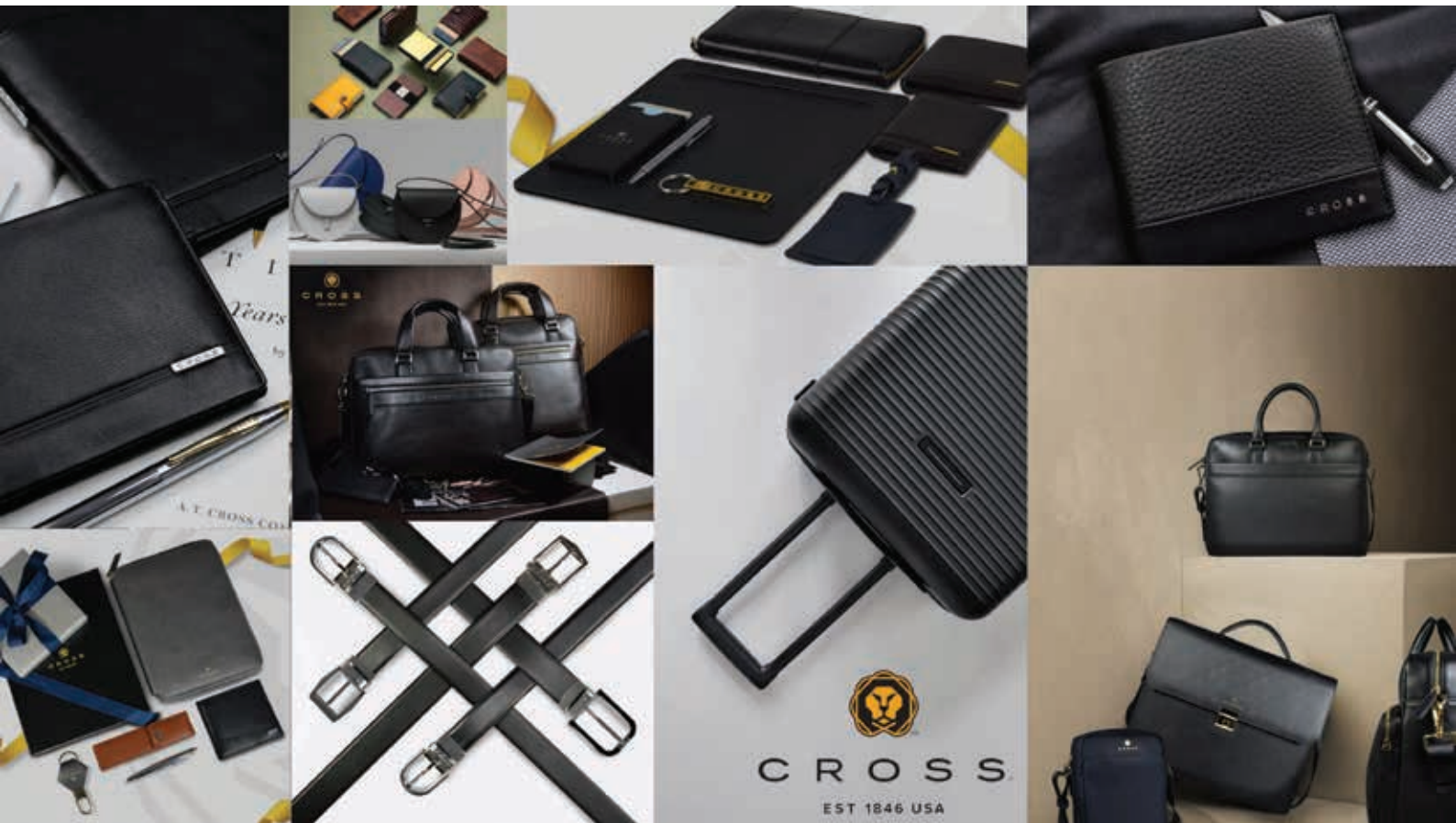



# CROSS LAPTOP BAG WITH TROLLEY STRAP



Brown



Black



Navy Blue

READY STOCK

- > Office Laptop Bag from Premium Vegan Leather
- > Trolley strap attaches to trolley bag for ease of travel
- > Shoulder strap-on the go

## JASPER

MBCRS 882 - Black    MBCRS 883 - Brown    MBCRS 884 - Navy Blue

This is a 15" CROSS Briefcase that is made up of durable and Premium quality Vegan Leather which is designed to fit 15" laptops of most brands. It is Lightweight and comfortable to carry with adjustable shoulder strap. This Briefcase has decent capacity to store essentials with inside zipper pockets to put your valuable items along with 2 more utility pockets. It also has Zipper closure for handy access. It is perfect for business, travelling, meeting & shopping.

Print Technique : SC, ENG

Preferred Print Location : Front Bottom

Max Print Size : 40X 70 mm

Product Size : 40 x 30 x 7 cm



Black



Brown

READY STOCK



- Office Laptop Bag from Premium Vegan Leather
- Elegant Design
- Shoulder strap-on the go



Navy Blue

FRANCISCO

MBCRS 881 - Black MBCRS 887 - Brown MBCRS 893 - Navy Blue

Francisco is a 15" CROSS laptop briefcase made from a durable and rich quality Vegan leather with durable polydrill lining. It comes with a removable & adjustable shoulder strap. The bag has classy distressed vintage inspired look which never goes out of style.

Print Technique : SC, ENG

Preferred Print Location : Front Bottom

Max Print Size : 35 X 60 mm

Product Size : 40 x 30 x 7 cm



# OFFICE BAGS & CONFERENCE BAGS

## SANTHOME



Grey

Black

### GAYITI

MBSN 141 - Black MBSN 142 - Grey

**SANTHOME** Gayiti is a smart office bag with 15.6" laptop compartment and made from high grade PU leather. A large inner compartment is organized very effectively to provide enough space to hold your documents, books, laptop and other bulky items

Print Technique : SC, ENG, EMB Preferred Print Location : Top  
Max Print Size : 300 x 60 mm Product Size : 42 x 30 x 12.5 cm  
Packing Details : 47 x 35 x 44 cm; 10 pcs/carton; gw/nw: 15.9 kg/carton



Grey

Black

### TRITU

MBSN 143 - Black MBSN 144 - Grey

**SANTHOME** Tritu is an office bag that offers maximum protection using strong materials and a padded pocket for your laptop. It has two main compartments which offers enough space to carry all you need to your office. Two pockets on the front and one on the back provide additional storage space.

Print Technique : SC, ENG, EMB Preferred Print Location : Top  
Max Print Size : 300 x 50 mm Product Size : 42 x 30 x 12.5 cm  
Packing Details : 47 x 35 x 44 cm; 10 pcs/carton; gw/nw: 17.5 kg/carton



## XDXCLUSIVE®



### MBXD 101- MADRID MESSENGER BAG

**XDXCLUSIVE®** This 15.6" laptop bag offers comfortable style and safe storage for your laptop and tablet. With pockets to organize all of your tech gadgets and personal accessories. RFID safe sleeve for your wallet and passport. Connect your powerbank easily to the integrated USB charging port and charge your phone or tablet whilst on the go. PVC free. Registered design®

Print Technique : SC Preferred Print Location : Front  
Max Print Size : 150X 30 mm Product Size : 32 x 9 x 43 cm  
Packing Details : 47 x 38 x 67 cm ; 15 pcs/carton; 9 kg/carton

## Giftology



Navy Blue

Black



### Lightweight & Durable Messenger Bag

### KRIENS

MBGL 205 - Black MBGL 206 - Navy Blue

Print Technique : SC, HT Preferred Print Location : Front  
Max Print Size : 270 x 240 mm Product Size : 37 x 30 x 11.5 cm  
Packing Details : 45 x 35 x 38 cm; 30 pcs/carton; gw/nw: 13 kg/carton

READY STOCK





External Features:

- Webbing to keep the bag securely attached to luggage handles
- Front pocket with zipper for easy access
- Made of water-repellent nylon and durable coated canvas Zipper with Moleskine logo



READY STOCK



MBMOL 101 - Black MBMOL 102 - Slate Grey

**MOLESKINE®** An essential part of your urban nomadic kit: a practical, smart bag to carry your unique contents and tools as you move around the city. Bag can go everywhere with you, to work or around town. Essential equipment for the urban nomad. Follow your own track. Write your own story

Print Technique : SC

Preferred Print Location : Flap

Max Print Size : 250 x 80 mm

Product size : 39.1 X 13.1 X 28.1 cm

Packing Details : 57 X 43 X 34 cm ; 4 pcs/carton ; gw/nw: 6.2 kg / carton



The ID Backpack has a range of features, including:

- Webbing to keep bag securely attached to luggage handles
- Designed to fit a range of devices and fits up to 15" laptops
- Front pocket with zip for easy access
- Internal side pocket for storing essential items
- Made of water-resistant nylon and tough coated canvas

READY STOCK



BGMOL 101 - Black BGMOL 102 - Slate Grey

**MOLESKINE®** This smart, functional bag is made of sporty materials and has an intuitive fit. The ID Collection of bags are practical, comfortable and protective, and are able to adapt to your needs on the move from morning to night.

Print Technique : SC

Preferred Print Location : Flap

Max Print Size : 200 x 80 mm

Product size : 29.1 x 12.1 x 40.1 cm

Packing Details : 57.5 X 37 X 44 cm ; 4 pcs/carton ; gw/nw: 6.2 kg / carton



READY STOCK



NOMAD

BGMOL 103 - Black BGMOL 104 - Sapphire Blue

**MOLESKINE®** The Moleskine Nomad backpacks are designed to lightly encase everything you need to stay connected and creative on the move. Designed to feel weightless and very spacious, the Nomad bag is perfect to carry anything from documents and notebooks to pens, pencils, USB cables, headphones and all the things you need. Never leave home without missing anything and travel around the city with ease.

Print Technique : SC

Preferred Print Location : Flap

Max Print Size : 180 x 80 mm

Product size : 29.2 x 41.3 x 17.8cm

Packing Details : 32.5 X 20 X 45 cms ; 1 pcs / carton ; gw / nw : 1.85 kg / carton





- > Made from Recycled PET fabric certified by Global Recycled Standards
- > 3% of sales proceeds of each product is committed to Water.org
- > High-end Sustainable
- > This bag saved 43 liters of water
- > This Bag is made by recycling 17 plastic bottles



**GO directly to office from gym -  
Go directly to gym from office**

**AN EXECUTIVE  
Duffel Bag**

**SAY NO TO GREENWASHING**

*Tell the true story of sustainability with genuine recycled rPET*

**Certified by**



**GIFTS THAT GIVE BACK**

785 million people - 1 in 9 - lack access to safe water. We are supporting Water.org to change this.

For each CHANGE bag sold, 3% of sales is donated by brand owners to Water.org to save lives with safe water and sanitation.



**READY STOCK**



**DBSN 661 - PEGEIA**

SANTHOME CHANGE Duffel / Weekender / Gym Bag made from high-end durable 1680D recycled rPET (certified by GRS) and stylish leather components. Includes special shoe compartment. Each bag saves 43L of water and reuses 17 plastic bottles, while supporting Water.org to provide safe water to people in need with each purchase.

Print Technique : SC, HT

Preferred Print Location : Pocket

Max Print Size : 100 X 200 mm

Product size : 54 x 26 x 25 cm



**IMPACT**

AWARE™ RPET WEEKEND DUFFLE BAG

XD COLLECTION

**SAY NO TO GREENWASHING**

*Tell the true story of sustainability with genuine recycled rPET and cotton with validated claims.*

Certified by Global Recycled Standard

**GIFTS THAT GIVE BACK**

- 785 million people - 1 in 9 - lack access to safe water. We are supporting Water.org to change this.
- For each IMPACT bag sold, 2% of sales is donated by the Xindao B.V. (Netherlands) to Water.org to save lives with safe water and sanitation.



READY STOCK

- 2% of proceeds of each product committed to Water.org
- This bag is made of 45 recycled bottles
- Made with AWARE™ tracer
- This bag saved 27 liters of water



DBAW 457 - DUFFLE BAG

**XDDESIGN** No greenwashing, but telling a true story about sustainability! This Impact collection is made with AWARE™ tracer. With AWARE™, the use of genuine recycled fabric materials and water reduction impact claims are guaranteed, by using the AWARE disruptive physical tracer and blockchain technology. Save water and use genuine recycled fabrics. If you choose this item you save 27 litres of water and 45 plastic bottles have been reused. With the focus on water, 2% of proceeds of each Impact product sold is donated to Water.org. The AWARE™ weekend duffle impresses with its modern and simple look. Its clean design makes the duffle ideal for travel. The roomy main compartment offers plenty of space for your essentials. Two mesh pockets make your smaller items easy to find. The front zipper pockets have 2 sleeve pockets and 2 pen loops. Interior and exterior 100% recycled polyester with AWARE™ tracer. PVC free.

Print Technique : SC

Preferred Print Location : Front

Max Print Size : 250 x 35 mm

Product Size: 32 x 22 x 55 cm

Packing Details: 43 X 36 X 59 cms ; 15 pcs / carton ; gw / nw : 11.5 kg / carton



- > Made from Recycled PET fabric certified by Global Recycled Standards
- > 3% of sales proceeds of each product is committed to Water.org
- > This bag saved 35 liters of water
- > This Bag is made by recycling 14 plastic bottles
- > Expandable zipper adds additional storage
- > Back trolley strap to attach backpack to trolley bag

**-35L**  
**14**

**SAY NO TO GREENWASHING**

*Tell the true story of sustainability with genuine recycled rPET*

Certified by Global Recycled Standard

**GIFTS THAT GIVE BACK**

- 💧 785 million people - 1 in 9 - lack access to safe water. We are supporting Water.org to change this.
- 💧 For each CHANGE bag sold, **3% of sales is donated** by the brand owner to Water.org to save lives with safe water and sanitation.



**READY STOCK**



Excellent storage space



Trolley Strap for attaching to trolley bag



Expandable Zipper

**BPSN 796 - MARGO**

SANTHOME CHANGE Laptop Backpack made from high-end durable 1680 recycled rPET (certified by GRS) and stylish leather components. Elegant executive design. Extra zipper provided expandable storage space. Each bag saves 35L of water and reuses 14 plastic bottles, while supporting Water.org to provide safe water to people in need with each purchase.

Print Technique : SC

Product size : 44 x 30 x 13 cm (Expanded) 44 x 30 x 17 cm

Preferred Print Location : Front Top & Bottom

Packing Details : 69 x 60 x 49 cm ; 6 pcs /carton ; gw/nw: 10.9 kg/ carton

Max Print Size : 100 X 130 mm

SANTHOME

**CHANGE.**  
SERIOUS SUSTAINABILITY





**SAY NO TO GREENWASHING**

*Tell the true story of sustainability with genuine recycled rPET*

**Certified by** Global Recycled Standard

**GIFTS THAT GIVE BACK**

785 million people - 1 in 9 - lack access to safe water. We are supporting Water.org to change this.

For each CHANGE bag sold, **3% of sales is donated** by the brand owner to Water.org to save lives with safe water and sanitation.



- > Made from RPET fabric, certified by Global Recycled Standard (GRS)
- > Elegant slim design, perfect for commuters
- > 3% of sales proceeds of each product is committed to Water.org
- > This bag has saved 16 liters of water
- > This bag is made from reusing 6 plastic bottles

**READY STOCK**



**-16L** **6**



**BPSN 2103 - SANOK**

SANTHOME CHANGE 15.6" Slim Commuter Laptop Backpack made from premium durable recycled PET (rPET), certified by the Global Recycled Standard (GRS). Elegant executive design and stylish fittings. Each bag saves 16L of water and reuses 6 plastic bottles, while supporting Water.org to provide safe water to people in need with each purchase.

Print Technique : SC

Preferred Print Location : Front

Max Print Size : 200 x 150 mm

Product Size: 45 X 31 X 8 cm





READY STOCK

- > 2% of proceeds of each product donated to Water.org
- > This bag is made of 33 recycled bottles
- > Made with AWARE™ tracer
- > This bag saved 19 liters of water

-19L 33

**SAY NO TO GREENWASHING**

*Tell the true story of sustainability with genuine recycled rPET and cotton with validated claims.*

Certified by

**GIFTS THAT GIVE BACK**

- 785 million people - 1 in 9 - lack access to safe water. We are supporting Water.org to change this.
- For each IMPACT bag sold, 2% of sales is donated by the Xindao B.V. (Netherlands) to Water.org to save lives with safe water and sanitation.

BGAW 458 - Black    BGAW 459 - Anthracite    BGAW 460 - Navy Blue

**XD COLLECTION** No greenwashing, but telling a true story about sustainability! This Impact collection is made with AWARE™ tracer. With AWARE™, the use of genuine recycled fabric materials and water reduction impact claims are guaranteed, by using the AWARE disruptive physical tracer and blockchain technology. Save water and use genuine recycled fabrics. If you choose this item you save 19 litres of water and 33 plastic bottles have been reused. With the focus on water, 2% of proceeds of each Impact product sold has been donated to Water.org. The streamlined AWARE™ 15.6" laptop backpack includes a laptop sleeve in the main compartment and an inside sleeve pocket with 2 pen loops. A separate front zipper pocket can hold your small daily essentials. Interior and exterior 100% recycled polyester with AWARE™ tracer . PVC free.

Print Technique : SC      Preferred Print Location : Front      Max Print Size: 180 X 40 mm  
 Product Size : 44.5 X 12 X 30.5 cm      Packing Details : 49.5 X 38.5 X 48.5 cm ; 12 pcs / carton ; gw / nw : 5.5 kg / carton

XDDESIGN

# BOBBY SOFT

Anti - Theft Backpack







A new take on the ORIGINAL Bobby Anti-theft Backpack

Scan Below QR  
code to watch  
product video



Black



Navy Blue



Grey

- > Iconic Bobby antitheft design
- > Made from Recycled PET and AWARE® tracer
- > Each Bobby Soft saves 23L of water and reuses 39 plastic bottles

READY STOCK



ORGANISER PANEL AND INTERNAL POCKETS



INTEGRATED USB CHARGING PORT



SAFE ZIPPER PULLER



EXPANDABLE TOP



BOBBY SOFT

BGXD 696 - Black BGXD 697 - Grey BGXD 698 - Navy Blue

XDDESIGN® For university, school, work or your next trip, the Bobby Soft Backpack is ready! The iconic Bobby anti-theft design with hidden RFID protected pockets, no front access and hidden zippers is now complemented with a safe zipper puller on the main compartment. In the main compartment, you can easily organise your gear with a padded 15.6" laptop compartment, notebook pocket, smart pockets and a keychain clip. The top of the backpack is expandable giving additional space. This backpack is also equipped with an integrated USB charging port and water repellent material. Made from R-pet materials and AWARE™ tracer. With AWARE™, the use of genuine recycled fabric materials and water reduction is guaranteed, by using the AWARE disruptive physical tracer and blockchain technology. Each Bobby Soft saves 23L of water and reuses 39 plastic bottles. Registered design®

Print Technique : SC

Preferred Print Location : Front

Max Print Size : 200 X 150 mm

Product size : 30 x 18 x 45 cm

# REDUCING THE USE OF WATER

BY USING TRACEABLE AND CERTIFIED RECYCLED MATERIALS WE  
SAVE HUGE AMOUNTS OF WATER

## EACH XD DESIGN SUSTAINABLE BACKPACK:

### REUSE

AN AVERAGE OF

# 31

### WATER BOTTLES



### SAVED

AN AVERAGE OF

# 18



### LITRES OF WATER

Bobby + Recycled PET  
= **BOBBY HERO**  
Anti - Theft Backpack  
(The ORIGINAL just got better)





Red



Black



Green



Grey



Navy Blue

Made from (rPET)  
Recycled PET Bottles

Scan Below QR  
code to watch  
product video



Light Blue

- Each bag is made of 27 plastic bottles
- Each bag saves 16 liters of water
- Made with AWARE™ tracer

READY STOCK



BOBBY HERO

BGXD 625 - Black    BGXD 626 - Grey    BGXD 627 - Navy Blue    BGXD 628 - Red    BGXD 629 - Green    BGXD 630 - Light Blue

**XDDESIGN®** The Bobby Hero line is our new generation of anti-theft backpacks. This new model will help you to move safely, carefree and organised. Key features such as cut-proof protection, hidden zipper closures & pockets will keep your belongings safe during your commutes. Bobby is also the most convenient backpack with features such as an integrated USB charging port, water-repellent fabric, illuminating safety strips and a luggage strap. On the inside there are padded compartments for a 15.6" laptop, tablet up to 12.9" and all your other belongings. Made from R-pet materials and AWARE™ tracer. With AWARE™, the use of genuine recycled fabric materials and water reduction impact claims are guaranteed, by using the AWARE disruptive physical tracer and blockchain technology. Each Bobby Hero regular saves 16 litres of water and reuses 27 plastic bottles. Registered design®

Print Technique : SC

Preferred Print Location : Front

Max Print Size : 150 X 150 mm

Product size : 45 x 16 x 29 cm

Packing Details : 69 x 60 x 49 cm ; 6 pcs /carton ; gw/nw: 10.9 kg/ carton



# THE BOBBY SLING BAG



Made from genuine recycled fabric  
All IMPACT claims verified using AWARE disruptive physical tracer & Blockchain technology

**IMPACT**

For each product sold we have donated 2% of proceeds to support Water.org to change lives with safe water.

**THIS BAG IS MADE OF 20 RECYCLED WATER BOTTLES**



**THIS BAG SAVED 12L WATER**

785 million people — 1 in 9 — lack access to safe water

We are supporting Water.org to change this. [www.theimpactcollection.org](http://www.theimpactcollection.org)



Xindao B.V.  
The Netherlands

For more info visit: [www.theimpactcollection.org](http://www.theimpactcollection.org)

READY STOCK





Made from (rPET)  
Recycled PET Bottles



-  
12L



READY STOCK



BGXD 691 - BOBBY SLING

**XDDESIGN®** Safe, comfortable and smart, the Bobby Sling was designed for the city travellers. Feel protected with the famous Bobby anti-theft features like hidden zippers, no front access, RFID protected pocket and cut resistant material, also a 3 point safe buckle will make sure that your daily essentials are always along your body. Additional features like water-resistant material and integrated USB charging port makes this crossbody backpack the most convenient option for your everyday journey. Made from R-pet materials and AWARE™ tracer. With AWARE™, the use of genuine recycled fabric materials and water reduction impact claims are guaranteed, by using the AWARE disruptive physical tracer and blockchain technology. Each Bobby Sling saves 12 litres of water and reuses 20 plastic bottles. Registered design®

Print Technique: SC Preferred Print Location : Front Max Print Size : 120 X 120 mm  
Product size : 32.5 x 9 x 21 cm Packing Details : 38 x 51 x 53.5 cm ; 8 pcs /carton ; gw/nw: 7.5 kg/ carton



Scan Below QR code to watch product video



READY STOCK

# Bobby Bizz

XDDDESIGN®

THE BEST BUSINESS BRIEFCASE + BACKPACK



INTEGRATED ZINC ALLOY LOCK IN THE RIGHT STRAP



QUICKLY LOCK YOUR BAG TO ANY FIXED OBJECT WITH THE INTEGRATED ZINC ALLOY LOCK



DISCREET POCKETS FOR EASY ACCESS



# Bobby Bizz

THE BEST BUSINESS BRIEFCASE + BACKPACK



READY STOCK

PADDED INTERIOR  
LAPTOP, TABLET &  
ACCESSORY POCKETS

BACK PANEL WITH ELASTIC  
STRAP DESIGNED TO SLIP OVER  
TROLLEY HANDLES

INTEGRATED USB  
CHARGING PORT



**BGXD 750 - BOBBY BIZZ**

XDDESIGN Bobby Bizz is the best Business Backpack + Briefcase. It is an Anti-theft backpack with a number of edge cutting features that makes you love this bag. It is one of the most funded projects on Kickstarter.

Product Size: 31 x 44.5 x 10 cm    Packing Details : 68 X 44 X 47 cm ; 6 pcs / carton ; gw / nw : 10.96 kg / carton



# BOBBY TECH

- > Solar Powerbank Backpack
- > Integrated Wireless Charger
- > Patented Fid Lock System
- > Anti-Theft Backpack Series - Regd. Design



READY STOCK

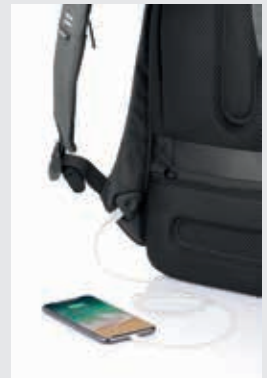

**BGXD 621**

XDDDESIGN® Bobby Tech is the ultimate backpack for gadget lovers; combining safety, comfort and the latest technology into great features. The integrated solar panel will ensure that you can charge your devices directly from solar power and never run out of power. An integrated wireless charging module makes sure you can charge your mobile device without the hassle of any cables. Bobby Tech has adjustable internal dividers which allow you to divide your backpack in many different ways. The patented fid lock system on the shoulder strap gives you quick and easy access to your phone or bottle/coffee cup. And of course the original Bobby features as hidden zippers, RFID protected pockets and cut proof PP board protection are still there. Registered design®

Print Technique : SC, HT  
 Product size : 41 X 27.3 X 16.5 cm

Preferred Print Location : Side  
 Packing Details : 68 x 44 x 47 cm ; 6 pcs /carton ; gw/nw: 7.5/8.5 kg / carton





READY STOCK



- > Made from GRS Certified RPET
- > Modern minimalist design

**BARUTH**

**BPGL 674** - Black **BPGL 675** - Grey **BPGL 676** - Blue

Baruth Office Laptop Backpack is made with GRS-certified RPET. Many useful features include external USB for smart charging, side pocket, front pocket for quick access and trolley harness.

Print Technique : SC, HT  
 Product size : 42 X 31 X 16 cm

Preferred Print Location : Front  
 Packing Details : 46 x 35 x 47 cm ; 10 pcs /carton ; gw/nw: 12/13 kg / carton

Max Print Size : 200 x 150 mm



Blue



Black

READY STOCK



Grey



Exterior Fabric is Anti-Bacterial



MALACCA

BPGL 671 - Black BPGL 672 - Grey BPGL 673 - Blue

Giftology Everyday backpack with Antibacterial exterior fabric to ensure that your backpack is free from harmful disease - causing bacteria. Commute and travel with this backpack without worrying about accumulating bacteria on your backpack during multiple contact with foreign surfaces. This backpack features a 15" laptop compartment, a USB external charging port, easy to access 2 front compartments and a water bottle pocket on the outside.

Print Technique : SC Preferred Print Location : Front Max Print Size : 200 X 150 mm  
Product size : 42 X 30 X 10 cm Packing Details : 60 x 45 x 42 cm ; 25 pcs /carton ; gw/nw: 13/12 kg/ carton



READY STOCK



- Moulded Front Case That Provides Excellent Branding Possibility
- 15" Laptop Compartment
- 180 Degree Opening Large Compartment
- Quick Access Compartment On Front
- Trolley Strap On Back



**BPSN 900- DRANCY**

SANTHOME Drancy is a moulded backpack with a 15" laptop compartment, a large main compartment to keep all your important stuff and a quick access front compartment to keep other gear. Back strap allows for the bag to be securely attached to a trolley.

Print Technique : SC

Preferred Print Location : Front

Max Print Size : 100 x 100 mm

Product Size: 46 X 31 X 17 cm

Packing Details : 50 x 50 X 32 cm ; 6 pcs /carton ; gw/nw: 6kg / carton



READY STOCK



- > 17" Laptop Backpack
- > Tablet Compartment
- > Structured Design For Easy Use
- > Integrated External USB Port



BPSN 791 - ROSARIO

**SANTHOME** Rosario is an attractive backpack that looks professional, stylish, and comfortable to wear all-day long. It has one main compartment and pockets on the front & back to keep your essentials. An external USB allows you to charge your phone outside while keeping the power bank (not included) inside. Pocket on the shoulder strap allows you to your daily- use quick access cards for convenient use. Reflective tapes on the front and the back makes sure the bag is visible even in the dark. Packed in individual box.

Print Technique : SC Preferred Print Location : Front & Side  
Max Print Size : 110 x 80 mm Product Size : 47 x 32 x 15 cm  
Packing Details : 70 x 57 x 49 cm ; 6 pcs / carton ; gw / nw ; 9.3 kg / carton



- > 17" Laptop Backpack
- > Tablet Compartment
- > Structured Design For Easy Use
- > Integrated External USB port



BPSN 792 - POSADAS

**SANTHOME** Posadas is an attractive backpack that looks professional, stylish, and comfortable to wear all-day long. It has one main compartment and pockets on the back to keep your essentials. An external USB allows you to charge your phone outside while keeping the power bank (not included) inside. Pocket on the shoulder strap allow you to your daily use quick access cards for convenient use. Packed in individual box.

Print Technique : SC Preferred Print Location : Front & Side  
Max Print Size : 110 x 80 mm Product Size : 47 x 32 x 15 cm  
Packing Details : 70 x 57 x 49 cm ; 6 pcs / carton ; gw / nw ; 9.3 kg / carton



**BPSN 916 - SHOBAC**

**SANTHOME** Shobac is a 18"laptop backpack for the modern man who wants to work hard during the day and perform sports or go the gym in his leisure time. This backpack has 2 main compartments, a side mesh pocket, an air mesh back and high quality jaquard lining. Be active, Be smart!

Print Technique : SC, ENG Preferred Print Location : Front Flap Max Print Size : 140 x 50 mm  
 Product Size : 45 x 30 x 14.5 cm Packing Details : 49x 38 x 58 cm ; 10 pcs / carton ; gw / nw ; 13 kg / carton

READY STOCK



- Big Capacity 18" Backpack
- Integrated External USB Port
- Back Padded For Comfort

**BPSN 918 - ELEBAC**

**SANTHOME** Elebac is a 18.5"laptop backpack made from 100% high quality nylon material and with two main compartments. The external charging USB allows your digital devices to be charged outside while your power bank sits inside the bag. The bag has high quality jaquard lining inside. For added comfort, the back panel is padded. There are comfortable and adjustable shoulder straps as well as a convenient top carry handle.

Print Technique : SC Preferred Print Location : Front Flap  
 Max Print Size : 200 x 60 mm Product Size : 47 x 30 x 14.5 cm  
 Packing Details : 50 x 38 x 61 cm ; 10 pcs / carton ; gw / nw ; 8kg / carton



- 15.4" Laptop Compartment
- Excellent Branding Possibilities
- Two Main Compartments
- High Quality Flat Grained PU Material

**BPSN 921 - VINBAC**

**SANTHOME** Vinbac is a laptop backpack for the stylish modern man. It is made from artificial leather and is lightweight and comfortable. It has a 15.4" laptop compartment. The double padded shoulder straps ensure comfortable carrying.

Print Technique : SC, ENG, UV, SC Preferred Print Location : Front Pocket  
 Max Print Size : 32 X 25 mm Product Size : 30.5 X 15.5 X 43 cm  
 Packing Details : 47 x 54 x 66 cm ; 6pcs /carton ; gw/nw: 7.5 kg / carton



# PROMOTIONAL BACKPACKS & SCHOOL BAGS

READY STOCK



- > 600D Day Bag
- > Perfect For Outdoor Excursions
- > Quick Access Pocket On Front
- > Light Weight

### BPMK 114 - ROTORUA

Day bag perfect for outdoor excursions. Made from 600D material, this light weight backpack lets you keep your tools safe in the front pocket and main compartment. Accessories in grey and padded back.

Print Technique : SC, HT Preferred Print Location : Front  
Max Print Size : 90 x 90 mm Product Size : 23 x 40 x 12 cm  
Packing Details : 50 X 50 X 28 cm ; 50 pcs/carton ; gw/nw: 6 kg / carton

Giftology



- > One Main Compartment And Additional Compartment On Front

### BPGL 813 - KLOTEN

Giftology Basic 600D polyester backpack with zippered main & front compartment and adjustable shoulder straps

Print Technique : SC, HT Print Location : Front Top  
Max Print Size : 150 X 90mm Product Size : 40 x 30 x 13.5cm  
Packing Details : 45 x 35 x 43cm; 40 pcs/carton; gw/nw: 12.5 kg/carton



### BPMK 119 - DUNEDIN

Rectangular backpack made of resistant 600D polyester with elegant black finish. With back padding and shoulder straps, Including a padded inside compartment for laptops up to 15 inches, plus a built-in headphones output.

Print Technique: SC, HT Print Location : Front  
Max Print Size: 140 x 60 mm Product Size : 28 x 40 x 8 cm  
Packing Details : 50 x 37 x 44 cm ; 11 kg Pcs: 30/ carton

Giftology



### BPGL 780 - KADIE

Giftology Kadie is a basic backpack with one main compartment and two compartments on the front to keep small and easy to access items. Its padded back and shoulder straps makes it very comfortable to use.

Print Technique: SC, HT Print Location: Front Pocket  
Max Print Size : 120 x 180 mm Product Size : 42 x 29 x 16 cm  
Packing Details : 47x 36 x 45 cm; 30 pc/carton; gw/nw: 14 kg/carton



Giftology



**BPGL 805 - LANDSKRONA**

Giftology Landskrona is a useful cooler bag with adjustable shoulder strap made from fashionable 2 tone material. It has a pocket on the front and the inside is well protected to keep your food fresh for a longer time.

Print Technique : SC, HT Preferred Print Location : Front Max Print Size : 110 x 70 mm  
Product Size : 20 x 15 x 15 cm Packing Details : 65 x 36 x 42 cm; 80 pcs/carton; gw/nw: 15 kg/carton



Black



Red



Grey

**VENTA**

**DBMK 101 - Black DBMK 103 - Grey DBMK 104 - Red**

Document bag with zipper closure in soft 600D polyester finish in bright tones. With reinforced carrying handles in matching color, zipper and matching color side holders.

Print Technique : SC, HT Preferred Print Location : Front Pocket Max Print Size : 265 X 200 mm  
Product Size : 36.5 X 29 X 6 cm Packing Details : 31 X 35 X 44 cm ; 100 pcs / carton ; gw / nw : 13 kg / carton

READY STOCK

**SANTHOME**

Capacity: 6800 ml



- Food Safe Material
- Easy To Carry
- Party Bag With Party Container & Tray
- Aluminium Foil & Insulation Inside to Keep Cool / Hot

**SN 5101 - PICFUD**

Print Technique : SC Preferred Print Location : Top  
Max Print Size : 300 x 200 mm Product Size : 27 x 42 x 12 cm  
Packing Details : 46 x 30 x 53 cm ; 4 pcs /carton ; gw/nw : 4.5 kg / carton



**ARTESIA  
BPMK 124 - Wink**

Folding bag with fun emoji design in eye-catching yellow color. Made of soft 190T polyester, with matching color drawstring and adjustment accessory.

Print Technique : SC, HT Preferred Print Location : Front  
Max Print Size : 265 x 200 mm Product Size : 40 x 38 cm  
Packing Details : 20x 45 x55 cm ; 400 / carton ; gw / nw : 10 kg / carton



## DRAWSTRING BAGS

### Giftology



White



Black



Navy Blue



Red

#### DRASTIN

**BPDS 801** - White **BPDS 802** - Navy Blue **BPDS 803** - Red **BPDS 804** - Black  
Giftology Drastin is a 210D polyester drawstring bag with one main large compartment. The drawstring design is for shoulder or backpack carrying. The large imprint space makes this a very affordable giveaway with great brand visibility.

Print Technique : SC, HT      Print Location : Front  
Max Print Size : 230 x 320 mm      Product Size : 44 x 33 cm  
Packing Details : 38 x 52 x 40 cm ; 500 pcs/carton ; gw/nw: 20 kg/carton



#### BPMK 108 - PAPATOETOE

Drawstring backpack in 210T soft polyester, in shiny silver color with thick, black self closing strings and reinforced corners.

Print Technique : SC      Preferred Print Location : Front  
Max Print Size : 300 x 360 mm      Product Size : 34 x 42 cm  
Packing Details : 42 X 42 X 50 cm ; 9.5 kg Pcs: 200/ carton

READY STOCK



Orange



Yellow



Light blue



Pink

#### WAITEMATA

**BPMK 103**- Orange **BPMK 104**- Light blue **BPMK 105**- Pink **BPMK 107**- Yellow

Drawstring backpack in soft polyester 210T in cheerful and wide range of colors. With black self closing strings, corners with metal eyelets and PU leather reinforcement in matching color.

Print Technique : SC, HT      Preferred Print Location : Front      Max Print Size : 230 x 320 mm  
Product Size: 44 x 33 cm      Packing Details : 23 X 50 X 45 cm ; 300 pcs /carton ; gw/nw: 11 kg / carton

### LIVE YOUR DREAM !!!







*Eco friendly / cost effective / ideal for exhibitions*



Black

Royal Blue

White

Navy Blue

Cream

Red

**NW 001 V - NONWOA SOLID**

Print Technique : SC, HT

Preferred Print Location : Front & Back

Max Print Size : 260 x 300 mm

Product Size : 38 x 30 x 10 cm

Packing Details : 68 x 42 x 37.5 cm; 250 pcs/carton; gw/nw: 11.3 kg/carton



White/R.Blue

White/Grey

White/Black

White/Green



White/Navy

White/Orange

White/Red

White/Maroon

**NW 001 V - NONWOA EDGE**

Print Technique : SC, HT

Preferred Print Location : Front & Back

Max Print Size : 260 x 300 mm

Product Size : 38 x 30 x 10 cm

Packing Details : 68 x 42 x 37.5 cm; 250 pcs/carton; gw/nw: 11.3 kg/carton



White



Black

**NW 001 H - LUKAOK**

Print Technique : SC, HT

Preferred Print Location : Front & Back

Max Print Size : 390 x 250 mm

Product Size : 33 x 43 x 12 cm

Packing Details : 74 x 47 x 37.5 cm; 250 pcs/carton; gw/nw: 14 kg/carton



READY STOCK



**DO YOU KNOW THE WATER FOOTPRINT OF COTTON?**

It takes **20,000 Liters of water** to produce 1kg of cotton fiber.

Source: WWF

Continue reading



READY STOCK

300 GSM Sturdy Fabric

This Bag Saved

**-4,000 Litres**  
Water



**CTEN 425 - BORKUM**  
Eco neutral GRS-Certified Recycled Cotton Beach Bag in Natural color - Least / almost NIL Impact on environment  
Print Technique : SC  
Max Print Size : 330 x 420 mm  
Preferred Print Location : Front  
Product Size : 40 x 47 x 17 cm



300 GSM Sturdy Fabric

This Bag Saved

**-10,000 Litres**  
Water



- > Outside Zipper pocket for quick access & safety
- > Easy to wash-&-clean



**DBEN 430 - PUEBLA**  
Eco neutral GRS-Certified Recycled Cotton Duffel Bag in Natural color - Least / almost NIL Impact on environment  
Print Technique : SC  
Max Print Size : 180 x 160 mm  
Preferred Print Location : Front Pocket  
Product Size : 49 x ø26 cm



~~1,200 - 5,000~~  
Litres of water  
needed to  
make 1 normal  
Cotton Bag

Move to →

0.02 - 0.05  
Litres of water  
needed to  
make an eco neutral  
Recycled Cotton Bag

Please choose  
responsibly!



Natural

This Bag Saved

**-1,200**  
Litres

Water

140 GSM  
Light & Durable



Black



Ink Blue



Blue



ABLAR

CTEN 420 - Ink Blue CTEN 421 - Natural CTEN 422 - Black CTEN 423 - Blue

Eco neutral GRS-Certified Recycled Cotton Tote bag 140 gsm

Print Technique : SC

Preferred Print Location : Front

Max Print Size : 350 x 320 mm

Product Size : 42 x 36 cm



Natural



Black

READY STOCK

This Bag Saved

**-4,000**  
Litres

Water

300 GSM  
Sturdy Fabric



DARGUN

CTEN 427 - Natural CTEN 428 - Black

Eco neutral GRS-Certified Recycled Cotton Tote Bag with Bottom Gusset 300 GSM

Print Technique : SC

Preferred Print Location : Front

Max Print Size : 300 x 320 mm

Product Size : 42 x 38 x 10 cm



# COTTON BAGS & POUCHES



Black

Navy Blue



White

Natural



**CT 001 - STRUM**

Print T : SC, HT      Print L : Front & Back  
Max Print Size : 320 x 340 mm      Product Size : 42 x 38cm  
Packing Details : 46 x 46 x 48 cm;  
250 pcs/carton; gw/nw: 19.50 kg/carton



White



Natural



**CT 101 - TSIO**

Print T : SC, HT      Print L : Front & Back  
Max Print Size : 260 x 300 mm      Product Size : 38 x 32 x 12cm  
Packing Details : 46 x 46 x 48 cm;  
150 pcs/carton; gw/nw: 20 kg/carton

## eco-neutral



Dulux



**CT 501 - CAPTRU**

**eco-neutral** Cotton wallet with Foldable shopping bag  
Print T : SC, HT      Print L : Pouch & Bag  
Max Print Size : (Bag) 270 x 290 mm  
(Pouch) 80 x 50 mm  
Product Size : 12 x 11 x 3.5 cm (Pouch) 32 x 33 (Bag)  
Packing Details : 46 x 46 x 48 cm;  
225 pcs/carton; gw/nw: 18.375 kg/carton

READY STOCK



**BPMK 130 - BREA**

Bag made from 100% cotton material and in combination of body of natural color and handles in a varied range of bright tones. With 70cm long handles and stitched finishing. Takes up to 7kg of weight. 105 gsm.  
Print Technique : SC, HT      Preferred Print Location : Front  
Max Print Size : 330 x 350 mm      Product Size : 37 x 41 cm  
Packing Details : 45 x 40 x 30 cm;  
250pcs / carton ; gw / nw : 12 kg / carton



Mirvac



**CT 301 - SUSINOC**

Cotton Toiletry Pouch  
Print T : SC, HT      Print L : Front  
Max Print Size : 190 x 70 mm  
Product Size : 23 x 13 x 5cm  
Packing Details : 56 x 56 x 38 cm;  
100 pcs/carton gw/nw: 20.8 kg/carton



Equinor



**CT 601 - TRUIO**

Cotton Tablet Case  
Print T : SC  
Print L : Front  
Max Print Size : 230 x 110 mm  
Product Size : 29 x 22 x 5 cm



eco friendly / cost effective / all purpose bags



White



Natural



JT 101 - SISMAC

Print Technique : SC, HT Preferred Print Location : Front & Back  
Max Print Size : 250 x 300 mm Product Size : 38 x 30 x 12 cm  
Packing Details : 56 x 56 x 38 cm ; 100 pcs /carton ; gw/nw: 21.40 kg / carton



Natural



White



JT 201 - KRISKIT

Print Technique : SC, HT Preferred Print Location : Front & Back  
Max Print Size : 380 x 270 mm Product Size : 33 x 43 x 15 cm  
Packing Details : 56 x 56 x 38 cm ; 80 pcs /carton ; gw/nw: 20.4 kg / carton



READY STOCK



JTEN 2104 - FRUNZA

eco-neutral Jute/Cotton Bag  
Print Technique : SC Preferred Print Location : Front & Back  
Max Print Size : 350 X 240 mm Product Size : 42.5 x 34 x 14.5 cm

> Front & Back Canvas ensures clear printing



# ECO BAGS

Natural



Black



Blue



Front Pocket for convenience;  
Option of 3 colors



MONCLOVA

JTEN 432 - Natural JTEN 433 - Black JTEN 434 - Blue

Jute Bag with Front Pocket

Print Technique : SC, HT

Max Print Size : 380 x 230 mm

Preferred Print Location : Front & Back

Product Size : 44.5 x 35.5 x 11.5 cm

*eco friendly / cost effective / all purpose bags*

## eco-neutral

Natural



CT 401 - ZITUTE

eco-neutral Cotton Draw String Bags

Print Technique : SC, HT

Preferred Print Location : Front & Back

Max Print Size : 330 x 300mm

Product Size : 34 x 42cm

Packing Details : 46 x 46 x 48cm; 200 pcs/carton;

gw/nw: 20.90 kg/carton



White / green



RPET 001 - ANOKIS

Recycled RPET Bag

Print Technique : SC PPL : Front & Back

Max Print Size : 260 x 300 mm

Product Size : 38 x 30 x 12 cm

Packing Details : 34 x 42 x 40 cm; 100 pcs/carton;

gw/nw: 8 kg/carton

White



BPMK 127 - BRAWLEY

Bag made from 100% organic cotton material with natural color finish. With reinforced short handles of 35cm in green color, gussets and stitched finishing. Takes up to 9kg weight. 145gsm.

Print Technique : SC, HT Preferred Print Location : Front

Max Print Size : 360 x 340 mm

Product Size: 40 x 40 x 10 cm

Packing Details: 38 x 44 x 54 cm; 200 pcs / carton;

gw / nw: 17 kg / carton



READY STOCK

# Recycled PET Fabric Process

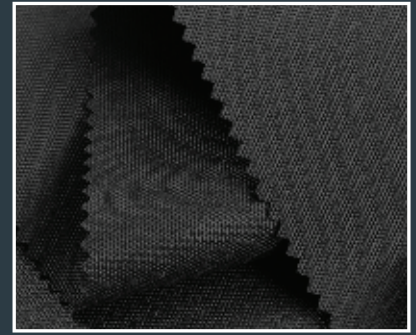
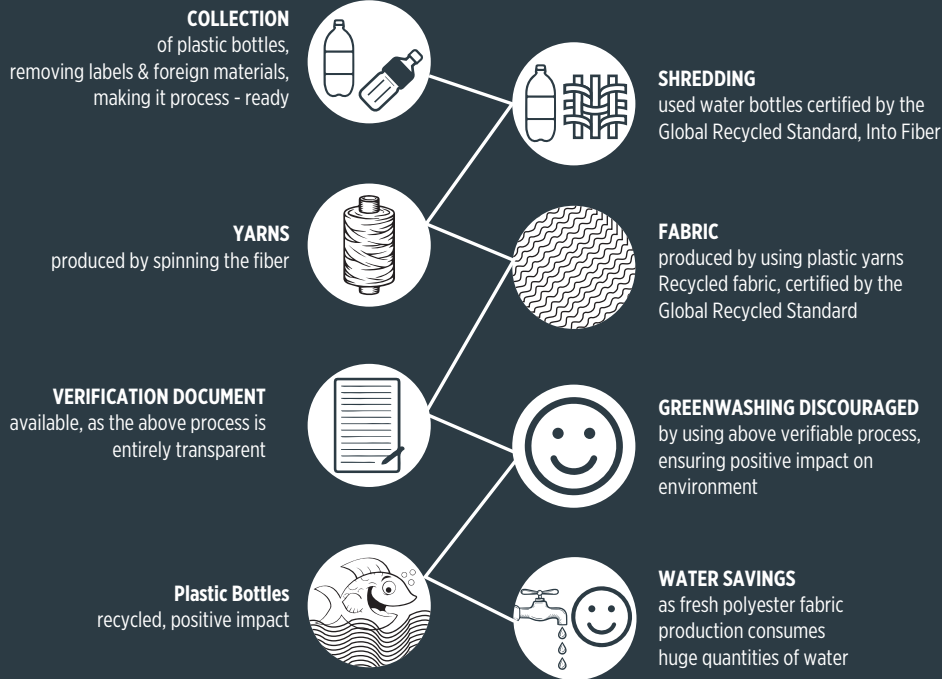

Recycled PET Fabric



**We Stock Recycled PET fabric & can supply Bags / Pouches  
made from GRS certified RPET fabrics in our U.A.E. factory**



## Benefits of producing Recycled PET fabric over normal fabric:

- Saves Energy
- Reduce pollution (CO<sub>2</sub> emissions)
- Fabric is sturdy - can produce Backpacks, Pouches, Laptop bags, Cooler bags.

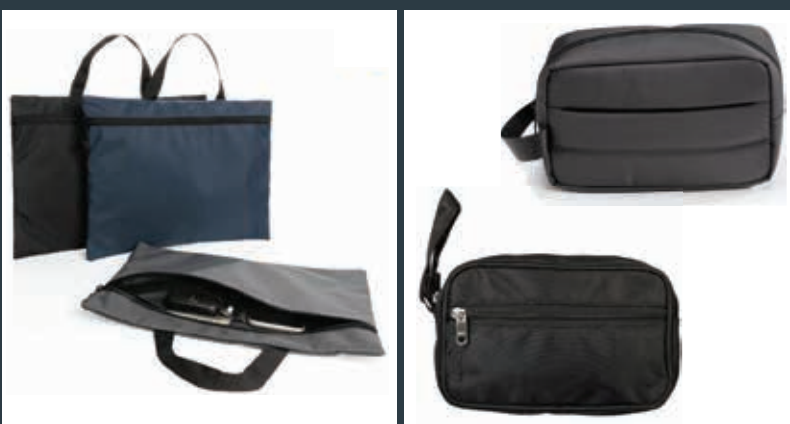



# CUSTOM MADE MISCELLANEOUS ITEMS

## Islamic Gifts



Navy Blue

Grey



Prayer Mat

Foldable Bag

Sleeper Bag

Foldable Haj - Umrah Set

PMT 001 - MATIER  
Product Size : 38 x 29 x 3.5 cm

CUSTOM MADE



Car kit A



Tool kit pouch A  
(No accessories included)



Bean bag



WC 001  
(Indian)

Spare wheel cover  
Available in Indian & Korean rexines

WC 002  
(Korean)





HAND CARRY FOOD DELIVERY BAG

BIKE RIDER  
FOOD DELIVERY BACKPACK

CUSTOM MADE



Pizza Delivery Bag



PORTABLE LUNCH BAG



# CUSTOM MADE BACK-TO-SCHOOL ITEMS



BP 020



CUSTOM MADE



School Bags



PCH 001

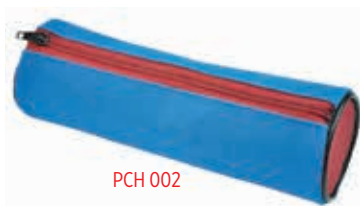

PCH 002



Kids Bags



MF 001



SB 201

Duffel bag with shoe compartment



CUSTOM MADE



SB 001



# CUSTOM MADE BAGS



**CBB 001**  
Cross Body Bag



**WP-005 A**  
Waist Bag



**SB 001A**  
Sling Bag



Tringle Bag

CUSTOM MADE

## Cosmetics Pouch / Gift Pouch



**CP 005**

## String Bag



**ST 101 B**  
Drawstring bag with front zipper pocket



**PC 010**  
PU Leather Handle Canvas Bag

## Waist Pouches



**WP 003 A**



TB-101



BF - 002  
Bill Folder



VIP - 001B  
Travel Bag



PU Leather Shopping Bag

CUSTOM MADE



Certificate Holder



Warranty Card



32 GB USB inbuilt  
Elegant gift box



Mobile/tablet stand  
80 sheet/160 pages notebook



# ELEGANT CORPORATE GIFTS

 10W  
Wireless Charger
  32GB USB  
device
  8000 mAh  
Power bank

Made for  
**MagSafe**



Grey

Made for  
**MagSafe**



Beige

READY STOCK



PREETZ

ITFO 391 - Beige ITFO 392 - Grey

SANTHOME This Magnetic Smart Notebook Portfolio combines design elegance and latest magnetic charging technology. With an impressive 8000 mAh powerbank, 10W MagSafe magnetic wireless charging, 32GB USB in-built flash drive, numerous ports, card pockets, phone/tablet pocket, pen loop, phone vertical/horizontal stand and an elegant refillable A5 notebook with ivory paper. Snap your phone (iPhone 12 or higher) to the wireless charger and the phone will align perfectly with the magnets inside. The 10W wireless charger is compatible with all Qi devices. Packed in an elegant sliding gift box.

Print Technique : SC, ENG

Preferred Print Location : Front Bottom

Max Print Size : 120 x 50 mm

Product size : 22.5 X 17 X 3 cm



READY STOCK



- > Fast Charging 10W wireless charging
- > Heavy duty 10,000mAh powerbank folder
- > Made with premium PU with high frequency welding technology



ITFO 1121 - GUBIN

SANTHOME Gubin is an A5 fast charging wireless powerbank folder and organizer with a built-in 10,000 mAh powerbank and 10W wireless charger. Contains a refillable notebook with 64 sheets, a premium phone/tablet magnetic stand, pen loop and pockets for phones, credit cards, cables, etc.

Print Technique : SC, UV, ENG

Print Location : Bottom Max Print Size : 130 x 50 mm

Product Size : 23 x 16.6 x 2.6 cm



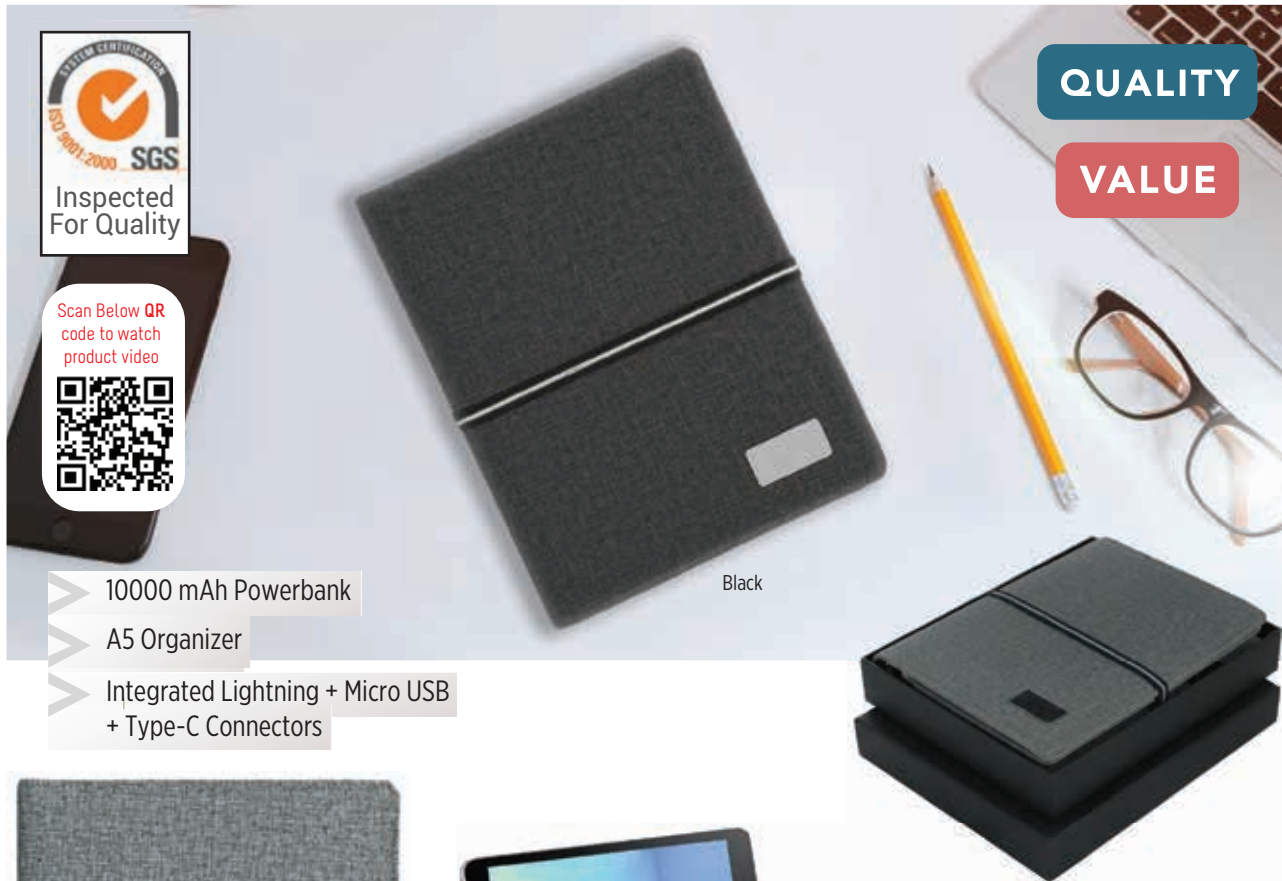

QUALITY

VALUE



- 10000 mAh Powerbank
- A5 Organizer
- Integrated Lightning + Micro USB + Type-C Connectors

Black

READY STOCK



Grey



Center flap to store mobile phone, cables, travel documents etc

Input charging USB cable      Output charging Micro USB and Type C connectors  
 Output charging for all latest iPhones

AI GIO  
 ITGL 902 - Grey    ITGL 1103 - Black

Giftology Aigio is an A5 notebook organizer with a built in 10000 mAh powerbank. It also has removable 120 pages each of 80 gsm. Integrated USB port for input charging along with Lightning, Micro USB & Type-C connectors capable of charging all available mobile phones & tablets. Aigio can fully charge an iphone or an android device atleast 2-3 times. An elastic band holds and secures everything. Input - 5V/2A; Output - 5V/2A.

Print Technique : SC, ENG, DM      Preferred Print Location : Front Metal Plate      Max Print Size : 20 x 30 mm  
 Product Size : 23 X 18.8 X 2.3 cm      Packing Details : 42 x 27 x 46 cm; 20 pcs/carton; gw/nw: 20 kg/carton



# WIRELESS CHARGER NOTEBOOK WITH PHONE STAND

# SANTHOME



READY STOCK



**NBSN 5126 - KAMEZ**

SANTHOME Wireless Charger (15W fast charging) A5 Notebook Organizer with in-built folding mini workstation - truly an avant-garde modern office notebook. Includes an integrated business cardholder, magnetic clasp with integrated pen loop, 192 A5 pages and a folding phone / pen stand. Opens flat due to excellent binding quality.

Print Technique : SC, UV, ENG  
Product size : 21.4 x 15 x 2.3 cm

Preferred Print Location : Bottom

Max Print Size : 130 x 45 mm



**IMPACT**

For each product sold we have donated 2% of proceeds to support Water.org to change lives with safe water.

**THIS PORTFOLIO IS MADE OF 7 RECYCLED WATER BOTTLES**

**THIS PORTFOLIO NOTEBOOK SAVED 4L WATER**

785 million people — 1 in 9 — lack access to safe water  
 We are supporting Water.org to change this.

Xindao B.V.  
 The Netherlands

For more info visit:  
[www.theimpactcollection.org](http://www.theimpactcollection.org)



READY STOCK

**Features -**



Confirms to the Cadmium Directive 91 | 338 | EC



U.S. Lead content compliance



Free from single & multichain chlorinated paraffins

NBAW 454 - Black NBAW 455 - Anthracite NBAW 456 - Navy Blue

**XD COLLECTION** No greenwashing, but telling a true story about sustainability! This Impact collection is made with AWARE™ tracer. With AWARE™, the use of genuine recycled fabric materials and water reduction impact claims are guaranteed, by using the AWARE disruptive physical tracer and blockchain technology. Save water and use genuine recycled fabrics. If you choose this item you save 4 litres of water and 7 plastic bottles have been reused. With the focus on water, 2% of proceeds of each Impact product sold is donated to Water.org. Keep all your work essentials organised with the A5 AWARE™ RPET portfolio. Inside the portfolio you can find a matching notebook. The notebook contains 64 sheets/128 sheets cream coloured lined 80gm/s FSC recycled paper. Inside you will find 1 big sleeve pocket, a phone pocket, 2 card slots and pen loop. Interior and exterior 100% recycled polyester with AWARE™ tracer. PVC free.

Print Technique : SC Preferred Print Location : Front Max Print Size : 100 x 80 mm  
 Product Size : 2.1 x 17.2 x 22.2 cm Packing Details : 26.5 X 37.5 X 39.5 cms ; 20 pcs / carton ; gw / nw : 11 kg / carton

# MOLESKINE CLASSIC COLLECTION



## NOTEBOOK SIZES



**X-Large**  
192 pages  
19 × 25 cm  
7 1/2" × 9 3/4"



**Large**  
240 pages  
13 × 21 cm  
5" × 8 1/4"



**Medium**  
208 pages  
11.5 × 18 cm  
4 1/2" × 7"



**Pocket**  
192 pages  
9 × 14 cm  
3 1/2" × 5 1/2"



**START  
TELLING  
YOUR STORY**

**AN ORIGINAL BRAND**

Leverage Your Brand  
The Corporate Idea

Scan Below QR  
code to watch  
product video

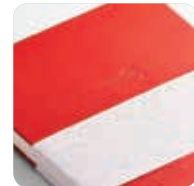
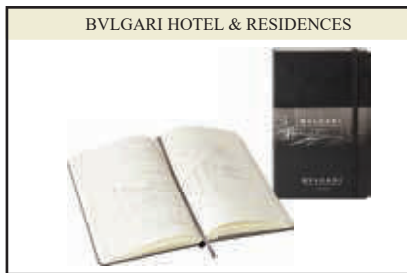
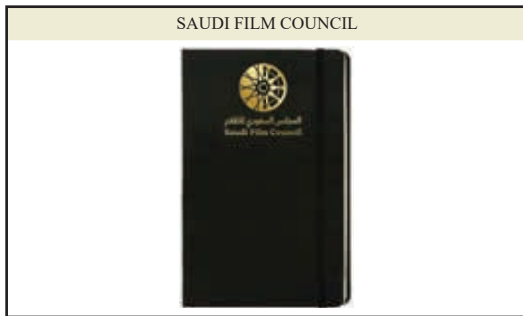

For additional details please refer to the Customization Guidelines

Moleskine notebooks are books to be written and our writing instruments fuel to communicate. They offer simple, thoughtfully designed, functional objects that can be turned into powerful communicators for the world's best brands. Start telling your story.

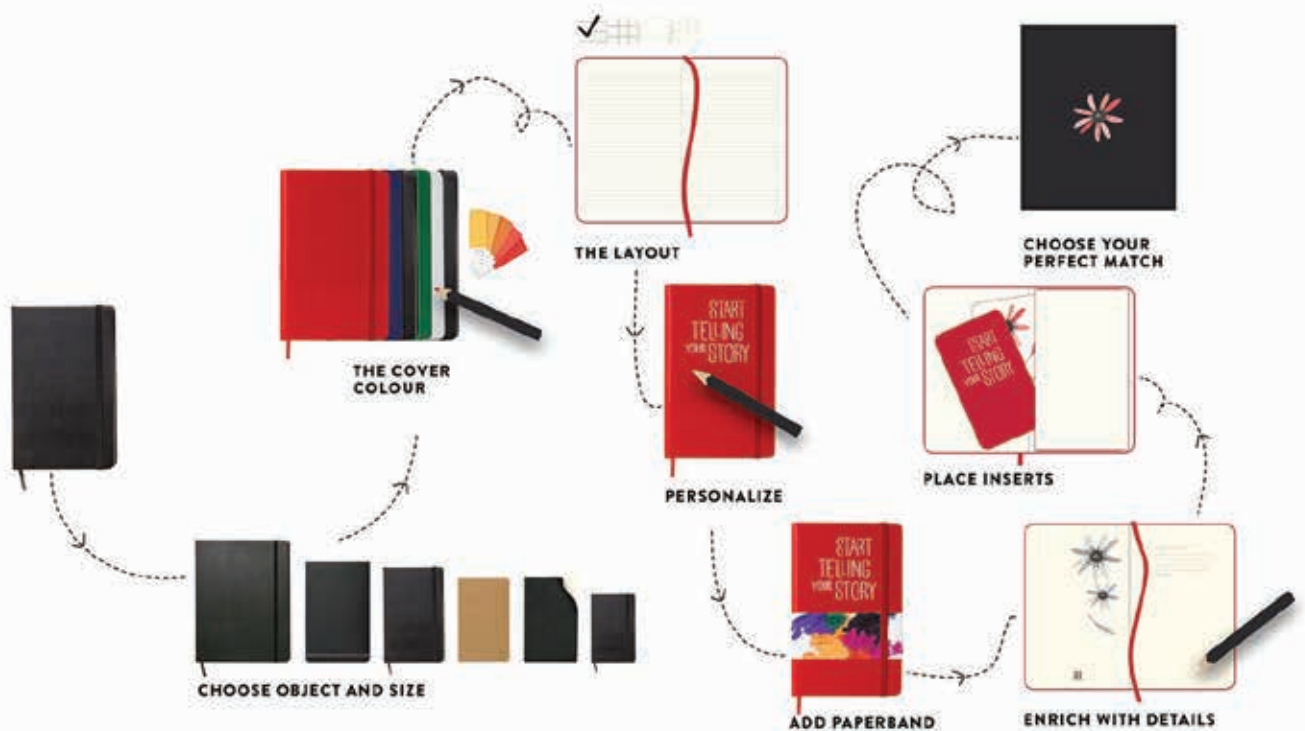



Scan Below QR code to watch product video



READY STOCK

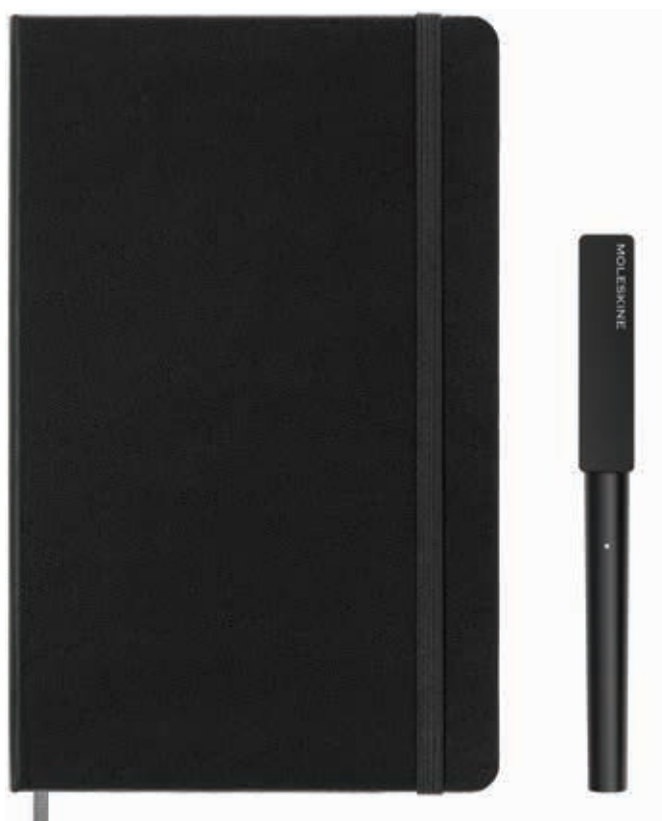

- Smart Notebook (large) with Ncoded paper designed to work with Smart Pen
- Automatically digitizes and transcribes your writing on the Moleskine Notes app
- Smart Tap the email icon to quick share your notes with anyone
- Works offline too, and sync notes later
- In-built voice recorder
- Contains 1 refill and magnetic charger
- Uses FSC® paper - certified forests and other controlled sources.



**OWMOL 103** - Moleskine Smart Writing Set

An instant-access kit that gives you a digital copy of every handwritten page. The Smart Writing Set includes the Smart Notebook with its recognizable Moleskine shape and ivory-colored pages, together with the redesigned Smart Pen and Notes App. These tools empower your ideas by building on the creative edge you get from working out ideas on paper. The Moleskine Notes app can be downloaded for free from the App Store™ and Google Play.

Product Size: 26 x 26 x 3 cm



**CLASSIC NOTEBOOK FEATURES**

- > Hard or soft cover, rounded corners, elastic closure
- > Ribbon bookmark
- > Expandable inner pocket in cardboard and cloth
- > Front endpaper with 'in case of loss' notice
- > Ivory-coloured 70 g/m<sup>2</sup> acid-free paper
- > Elastic closure, ribbon bookmark, innerpocket fabric matches cover colour



**OWMOL 331**  
Orange Yellow

Large ( 13 x 21 cm ) - Hard Cover - Ruled Notebooks



**OWMOL 313**  
Citron Yellow



**OWMOL 314**  
Orchid Purple



**OWMOL 329**  
Myrtle Green



**OWMOL 311**  
Slate Grey



**OWMOL 328**  
Sapphire Blue

**READY STOCK**



**OWMOL 332**  
Reef Blue



**OWMOL 305**  
Red



**OWMOL 306**  
Navy Blue



**OWMOL 307**  
White



**OWMOL 304**  
Black

Packing Details : 46 X 33 X 24 cm ; 48 pcs / carton ; gw / nw : 17.5 kg / carton



Large (13 × 21 cm) - Hard Cover - Plain Notebooks

Large (13 × 21 cm) - Soft Cover - Ruled Notebooks



OWMOL 309



OWMOL 308 - Black



OWMOL 319 - Sapphire Blue

Packing Details : 46 X 33 X 24 cm ; 48 pcs / carton ; gw / nw : 17.5 kg / carton

Packing Details : 44 X 31 X 24.5 cm ; 64pcs / carton ; gw / nw : 17 kg / carton

READY STOCK

XL (19 × 25 cm) - Soft Cover - Ruled Notebooks

Medium (11.5 × 18 cm) - Hard Cover - Ruled Notebooks



OWMOL 310



OWMOL 372 - Prussian Blue



OWMOL 371

Packing Details : 41 X 27 X 22 cm ; 24pcs / carton ; gw / nw : 12.5 kg / carton

Packing Details : 41 X 27 X 22 cm ; 48pcs / carton ; gw / nw : 12.2 kg / carton

Pocket (9 × 14 cm) - Hard Cover - Ruled Notebooks



OWMOL 301 - Black



OWMOL 302 - Navy Blue



OWMOL 303 - White

Packing Details : 44 X 34 X 16 cm ; 72pcs / carton ; gw / nw : 11.5 kg / carton

Packing Details : 44 X 34 X 16 cm ; 48pcs / carton ; gw / nw : 7.7 kg / carton





**Daily Diary 2023 Available In Hard Cover & Soft Cover**

- > Rounded Corners ; Elastic Closure
- > Ivory-colored, 70 G/m<sup>2</sup>, Acid-free Paper
- > Useful Tools: Travel Planning, Time Zones, International Measurements And Dialling Codes
- > Worldwide Holidays Calendar Available  
Moleskine.com / diaryaddons
- > Color-Coordinated Expandable Inner Pocket
- > 'In Case Of Loss' Notice Printed On The Flyleaf ; Matching Ribbon Bookmark
- > Reusable Paperband Backside Featuring Additional Printed Tools
- > Lies Flat, Opens At 180°



Hard Cover



Soft Cover

Calendar Planner



Time zone page



Expandable Pocket, Moleskine History, Stickers with thematic icons

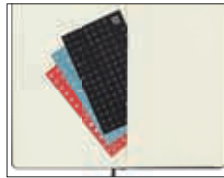

OWMOL 5130 - MOLESKINE 2023 DAILY PLANNER HARD COVER

OWMOL 5131 - MOLESKINE 2023 DAILY PLANNER SOFT COVER

Plan out every day in the minutest detail with the 12-Month Daily Diary/Planner. Dated from January to December 2023, this planner is formatted to show one whole page per day – so you have plenty of space to record events, appointments, to-dos, reminders and plans. Throughout the year, it grows into a day-by-day physical record of everything you've accomplished.

Product Size : (Hard Cover) 13 x 21 x 2.5 cm (Soft Cover) 13 x 21 x 2.1 cm

Packing Details : 47 x 28 x 31 cm ; 36 pcs /carton ; gw/nw: 20.1 kg / carton

READY STOCK

**Weekly Diary 2023 Available in Soft Cover**

- > Rounded Corners ; Elastic Closure
- > Useful Tools: Travel Planning, Time Zones, International Measurements And Dialling Codes
- > 'In Case Of Loss' Notice Printed On The Flyleaf ; Matching Ribbon Bookmark
- > Lies Flat, Opens At 180°

Calendar Planner



Time zone page



Expandable Pocket, Moleskine History, Stickers with thematic icons

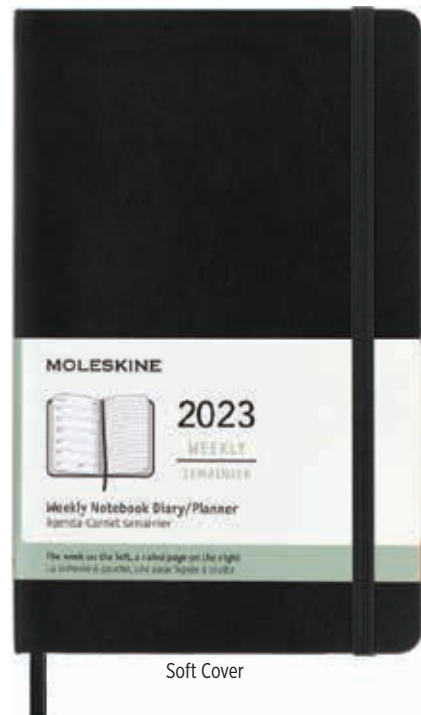
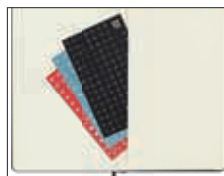

Soft Cover

OWMOL 5132 - MOLESKINE 2023 WEEKLY PLANNER SOFT COVER

With the 12-Month Weekly Diary/Planner. Dated from January to December 2023, this planner is formatted to show week planning-at-a-glance

Product Size : 13 x 21 x 1.2 cm

Packing Details : 24 x 25 x 30 cm ; 36 pcs /carton ; gw/nw: 8.5 kg / carton



READY STOCK



Black



Moleskine Go Pen



White

**A PERFECT MATCH: NEVER LOSE YOUR IDEAS WITH THESE TWO TOOLS, COMPLEMENTARY IN FORM AND FUNCTION**



**MOLESKINE CLASSIC LARGE NOTEBOOK & GO PEN SET**

OWMOL 325 - Black OWMOL 326 - White

**MOLESKINE** The Moleskine Notebook and Pen Pack is a set of 2 boxed collection featuring the Classic Ruled Large Notebook with a black hardcover, and the Moleskine Go pen in black. The notebook measures 15 x 21 cm and has 192 pages whilst the pen features black ink, a 0.5 mm tip and a clip designed to attach to the notebook. Both come in a set box with lid.

Product Box Size : 19.5 x 22.5 x 2.5 cm

Packing Details : 41 X 32 X 25.5 cm ; 25 pcs / carton ; gw / nw : 11.75 kg / carton

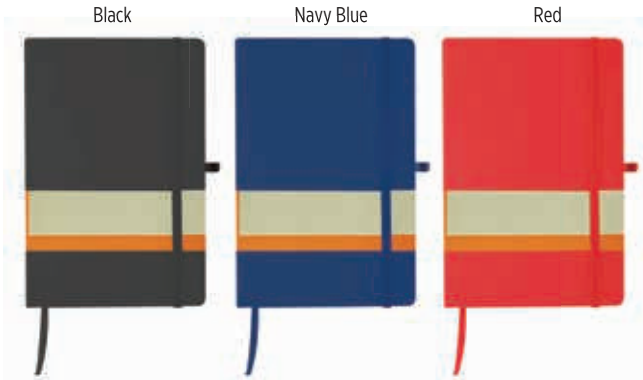

- > A5 Notebook; Ruled Pages
- > Elastic Closure ; Pen Holder Expandable Pocket
- > 192 Pages, 70g Ivory White Paper



BUKH  
**NBSN 101** - Black **NBSN 102** - Navy Blue **NBSN 103** - Red **NBSN 104** - White  
**NBSN 116** - Red 2 Tone

**SANTHOME** Bukh Hardcover A5 PVC notebook with matching coloured 3mm elastic closure, 192 ruled pages, 70gsm. Every notebook is thread bound and comes with rounded corners, a bookmark, a penloop, an elastic closure and an expandable inner pocket. Packed in a gift box.

Print Technique : UV, SC, EMB Preferred Print Location : Bottom Center  
 Max Print Size : 140 x 205 mm Product Size : 14.8 x 21 x 1.4 cm  
 Packing Details : 43.5 x 28.5 x 25.5 cm ; 60pcs/carton ; gw/nw: 17.5 kg / carton

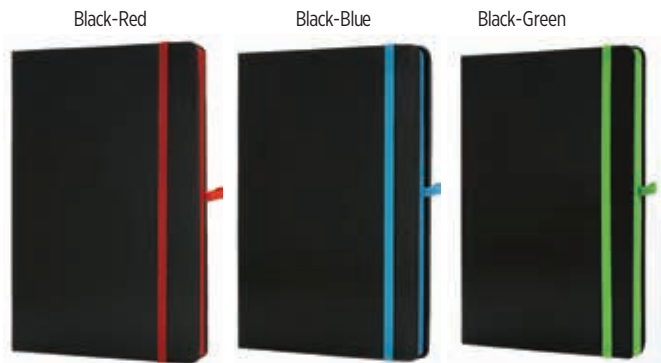

- > A5 Notebook; Ruled Pages
- > Edge-inked pages for color co-ordinated consistency
- > Elastic Closure ; Pen Holder, Expandable Pocket
- > 192 Pages, 70g Ivory White Paper

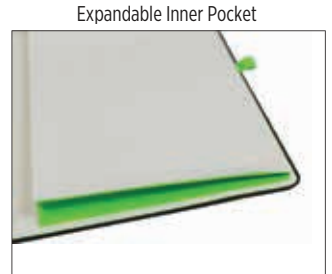
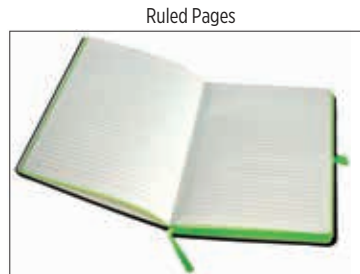

SUKH  
**NBSN 105** - Black-Blue **NBSN 106** - Black-Red  
**NBSN 107** - Black-Orange **NBSN 108** - Black-Green

**SANTHOME** Sukh Hardcover A5 PVC notebook with contrast colour sides and elastic band, 192 ruled pages, 70gsm. Every notebook is thread bound and comes with rounded corners, a bookmark, a penloop, an elastic closure and an expandable inner pocket. Packed in a gift box.

Print Technique : UV, SC, EMB Preferred Print Location : Bottom Center  
 Max Print Size : 140 x 205 mm Product Size : 14.8 x 21 x 1.4 cm  
 Packing Details : 43.5 x 28.5 x 25.5 cm ; 60 pcs /carton ; gw/nw: 17.5 kg / carton

READY STOCK



# NOTEBOOKS



Grey



Black

## SANTHOME

Expandable Inner Pocket

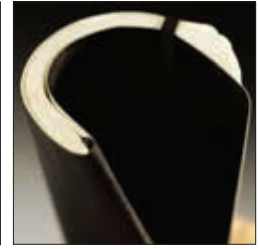
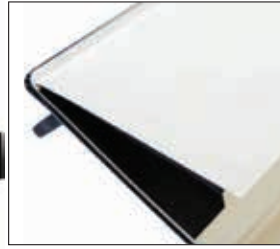

### QUALITY

A5

- > A5 Ruled Notebook
- > Soft Cover
- > Expandable Pocket

RULBUK

NBSN 114 - Black NBSN 115 - Grey

SANTHOME Plabuk Softcover A5 PVC notebook with matching coloured 3mm elastic closure, 192 ruled pages, 70gsm. Every notebook is thread bound and comes with rounded corners, a bookmark, a penloop, an elastic closure and an expandable inner pocket.

Print Technique : UV, SC, EMB Preferred Print Location : Bottom Center Max Print Size : 140 x 205 mm Product Size : 14.80 x 21 x 1.2 cm

Packing Details : 43.5 x 28 x 20.5 cm ; 60 pcs /carton ; gw/nw: 13.8 kg / carton

READY STOCK



## eco-neutral

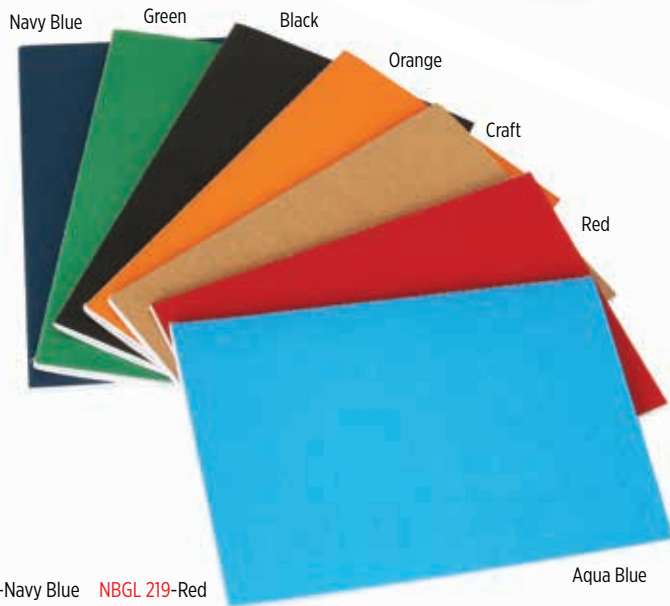

- > 80 Pages Ruled Notebook
- > Eco-Friendly Cover
- > A5 Size
- > Value Deal !!



VINICA

NBGL 215-Black NBGL 216-Craft NBGL 217-Aqua Blue NBGL 218-Navy Blue NBGL 219-Red

NBGL 220-Green NBGL 221-Orange

eco-neutral Classic design notebook with cardboard covers in eye-catching colors and smooth finish. With matching color seams on side and 80 ruled pages.

Print Technique : SC, UV

Preferred Print Location : Front

Max Print Size : 100 x 170 mm

Product Size: 20.5 x 14 x 0.5 cm



Black



Blue



Red



Green

READY STOCK



A5



BORSA  
 NBEN 103 - White NBEN 5101 - Black NBEN 5102 - Blue NBEN 5103 - Red NBEN 5104 - Green

**eco-neutral** Borsa is an eco friendly notebook with 160 pages each 80 gsm and made from a combination of fabric and cork materials. Also includes a matching Eco Friendly pen made from Cork and Eco-Friendly Wheat Straw. Packed in a gift box.

Print Technique : UV,SC Preferred Print Location : Front Bottom Max Print Size : 60 x 110 mm (Book) 40 x 7mm (Pen clip)  
 Box Size : 22 x 16 x 1.8 cm Packing Details : 50.8 x 35 x 25.8cm; 48 pcs/carton; gw/nw: 15.5 kg/carton



## SANTHOME PROTECT

- Cover made from recycled plastic (rPET) & treated with silver-ion Anti-Bacterial Technology
- FSC Certified Paper
- A5 Ruled Notebook, 160 Pages



Black  
Navy Blue  
Grey

BOOKMARK



**This Notebook Cares for You**  
Functional & Safe notebook that protects you against harmful microbes that may adhere to its surface. Kills 99.9% bacteria using Silver-Ion Technology.

**This Notebook Loves Trees**  
Paper used to make this notebook is FSC certified. FSC® certified paper is paper that has been harvested in a socially and environmentally responsible manner. By using a FSC certified paper, you are helping to ensure our forests are alive for generations to come.

**This Notebook Cares for the Environment**  
The fabric cover of the notebook is made using recycled post-consumer plastic. The rPET material itself is sourced from a Global Recycled Standard (GRS) certified factory. GRS certificate communicates truth in materials and support for a circular economy that reduces waste by using it to make new products.

**A notebook that is proudly made and a notebook you would proudly use!**

ORSHA

NBSN 341 - Black    NBSN 342 - Grey    NBSN 343 - Navy Blue

**SANTHOME PROTECT** A notebook that cares for you and for the environment. The cover of the notebook is made from recycled plastic (rPET) in a GRS Certified factory that complies with global recycling standards and is treated with anti-bacterial technology to provide protection against the growth of harmful bacteria. The paper used in this notebook is acid-free and FSC Certified. A5 notebook with 160 ruled pages each of 70 gsm

Print Technique : SC, HT

Preferred Print Location : Front

Max Print Size : 120 X 200 mm

Product Size : 14 X 21 X 1.4 cm

Packing Details : ( Black ) 36.5 X 33 X 24 cm ; (Black = 50 pcs) / carton ; (Grey& navy Blue = 59 pcs / carton gw / nw : 13.3 kg / carton

READY STOCK



XD COLLECTION



A5

Gold

Bronze

Silver

SURAKARTA

NBMK 101 - Silver    NBMK 102 - Gold    NBMK 103 - Bronze

PU leather notepad in eye catching metallic colors. Available in golden, silver and bronze colors. With hard covers, elastic band and matching color fabric bookmark. Including 80 plain sheets in ivory color.

Print Technique : SC, UV, EMB

Preferred Print Location : Bottom Center

Max Print Size : 100 x 160 mm

Product Size : 14.7 x 21 x 1.5 cm

Packing Details : 37.5 X 23.5 X 37.5 cm ; 50pcs/carton ; gw/nw: 13.5 kg / carton



Black Marble

White Marble

- A5 Ruled Notebook With PU Cover
- Excellent Branding Effects
- Trendy Gift

MARBLE

NBXD 706 - Black    NBXD 707 - White

XD Ruled A5 hardcover PU deluxe notebook in marble style with elastic closure and bookmark ribbon. 192 pages (96 sheets) of 80g/m2 inside. Cream coloured pages.

Print Technique : UV, SC, ENG, EMB

Preferred Print Location : Front

Max Print Size : 100 x 150 mm

Product Size : 20.0 x 14.0 x 1.5 cm

Packing Details : 19.5 X 22.5 X 32 cm ; 24 pcs / carton ; gw / nw : 7.58 kg / carton



READY STOCK

**NBEN 109 - STADE**

**eco-neutral** A5 Hard Cover PU Notebook with bamboo design. It has a folding front cover to act as a phone stand. 80 pages / 70 GSM.

Print Technique : SC, ENG Preferred Print Location : On Bamboo of Notebook  
Max Print Size : 50 X 20 mm

**GSEN 682 - BUNDE**

**eco-neutral** Gift set containing matching A5 PU & bamboo notebook with metal & bamboo pen, packed in stylish gift box. The notebook has a folding cover to act as a phone stand.

(Notebook) Print Technique : SC, ENG Preferred Print Location : On Bamboo of Notebook  
Max Print Size : 50 X 20 mm

(Pen) Print Technique : SC, ENG Preferred Print Location : On Bamboo of Pen  
Max Print Size : 30 X 5 mm



VALUE



READY STOCK



Ruled Pages

Blue



White



Red



Black



Green



Orange

A5

- >> A5 Hard Cover Notebook
- >> Ruled Pages
- >> Elastic Closure

PINGER

NBGL 203 - Black NBGL 204 - Navy Blue NBGL 205 - White NBGL 206 - Red NBGL 207 - Green NBGL 208 - Orange

Giftology Pinger is an A5 size Hard cover Notebook with 160 ruled pages, 70 gsm. It has a matching color satin bookmark, pen loop on the side & an elastic closure which keeps your notebook tightly closed wherever you go.

Print Technique : UV, SC

Preferred Print Location : Bottom Center

Max Print Size : 140 x 205 mm

Product Size : 13 x 21 x 1.4 cm

Packing Details : 44 x 39 x 15 cm; 50 pcs/carton; gw/nw; 11.5 kg/carton





- > PU Notebook Cover
- > 160 Ruled Pages, Rounded Corners
- > 1300 Meters Writing Length For Pen
- > Gift Box

White



READY STOCK

Black

Red

Orange

Pink

Royal Blue

Slate Grey

Green

Aqua

A5

**LIBELLET**

GSGL 201 - Black GSGL 202 - Royal Blue GSGL 203 - Red GSGL 204 - Orange GSGL 205 - Slate Grey GSGL 206 - Aqua  
 GSGL 207 - Green GSGL 208 - Pink GSGL 209 - White

Giftology Libellet is a notebook and pen set consisting of a hard cover PU notebook with a matching color pen with geometric design. The round cornered notebook consists of 160 ruled pages, 70 gsm with matching colored 3mm elastic closure, a bookmark and a pen loop. Packed in a gift box.

(Notebook) Print Technique : UV, SC, EMB Preferred Print Location : Front Max Print Size: 210 x 140 mm

(Pen) Print Technique : UV, SC Preferred Print Location : Clip Max Print Size: 8 x 37 mm

Product Box Size : 22.5 x 19.5 x 2 cm

Packing Details: ; 30 x 25 x 40 cm ; 32 pcs/carton ; gw/nw: 12.50 kg / carton



CREATIVE  
VALUE

Pen Attaches Magnetically To The Notebook !!

READY STOCK



Black



Blue



Green



Grey

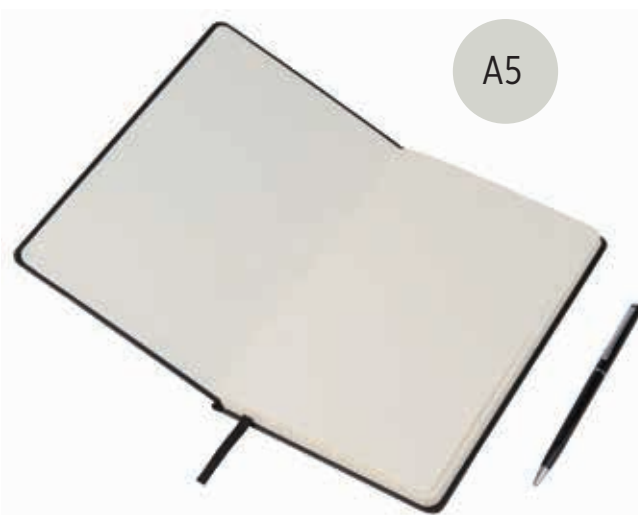

A5

- > Pen Attaches To The Magnet On The Notebook
- > 160 Pages ; 80 gsm
- > Gift Box
- > Value Deal !!



CAMPINA

GSGL 301 - Black GSGL 302 - Grey GSGL 303 - Blue GSGL 304 - Green

Giftology Campina is an A5 notebook with magnet inside the cover to attract the included matching twist action metal pen. The notebook consists of 80 sheets/160 pages of 80 gsm. Packed in a gift box.

(Notebook) Print Technique : UV, SC

Preferred Print Location : Front

Max Print Size : 90 x 180 mm

(Pen) Print Technique : UV, SC

Preferred Print Location : Next to clip

Max Print Size : 30 x 7 mm

Product Box Size: 15.5 x21.8x 1.7cm

Packing Details: 38 x 35 x 35.5 cm; 50 pcs /carton; gw/nw: 5.5 kg /carton



SANTHOME  
*19<sup>th</sup> Century Traditions*



Blue



Black

READY STOCK



- > 216 Ruled Pages
- > Notebook & Pen Set In Gift Box
- > Pen With German Dokumental® Ink
- > Modern Notebook With Legendary Flair



TOMAR

GSSN 403 - Black GSSN 404 - Blue

SANTHOME Heritage notebook that bring stylish neo-retro patterns to life with an urban and legendary flair. Tomar consists of 106 sheets/ 216 ruled pages each of 100 gsm. Also includes a stylish metal pen with 1200 meter writing German Dokumental® Ink.

(Notebook) Print Technique : SC, FO, UV, EMB

(Pen) Print Technique : SC, UV, ENG

Product Box Size : 19.6 X 18 X 2.5 cm

Preferred Print Location : Front

Preferred Print Location : Barrel

Packing Details : 37.5 X 21 X 40 cm ; 30 pcs / carton ; gw / nw : 15.4 kg / carton

Max Print Size : 160 x 100 mm

Max Print Size : 25 x 6 mm



A5

Blue



Lime



Red



White

- > A5 Hard Cover Notebook With Pen
- > 160 Pages Of 70g/m2 Inside
- > Gift Box

WAGGA

GSXD 111 - White GSXD 112 - Blue GSXD 113 - Red GSXD 114 - Lime

XD COLLECTION Ruled A5 hardcover standard notebook set including plastic pen. 160 pages of 70g/m2 inside. White coloured pages. Packed in Gift box.

(Notebook) Print Technique : UV, SC Preferred Print Location : Front

Max Print Size : 120 x 180 mm

(Pen) Print Technique : UV, SC Preferred Print Location : Next to clip

Max Print Size : 25 x 7 mm

Product Box Size : 22.5 x 17.2 x 2 cm

Packing Details : 38 x 25 x 36 cm ; 32pc /carton; gw/nw: 10.7kg / carton

A6



Royal Blue



- > A6 Hard Cover Notebook With Stylus Pen
- > 144 Pages Of 70g/m2 Inside
- > Gift Box

ALBURY

GSXD 122 - Silver GSXD 124 - Red GSXD 123 - Royal Blue

XD COLLECTION Ruled A6 hardcover classic notebook set including aluminium stylus pen. With elastic closure and bookmark ribbon. 144 pages of 70g/m2 inside. Cream coloured pages. Packed in Gift box.

(Notebook) Print Technique : UV, SC Preferred Print Location : Front

Max Print Size : 110 x 60 mm

(Pen) Print Technique : UV, SC Preferred Print Location : Next to clip

Max Print Size : 25 x 7 mm

Product Box Size : 15.7 x 12.2 x 2 cm

Packing Details : 46 x 19 x 30 cm ; 40pc /carton; gw/nw: 6.5 kg / carton

READY STOCK



Black

- > Gift Set with color matched items
- > All items with premium soft touch coating
- > Vacuum Bottle, Metal Pen and A5 notebook in gift box



White



Grey



Blue

READY STOCK

LAUTA

GSGL 861 - Black GSGL 862 - White GSGL 863 - Grey GSGL 864 - Blue

Giftology Gift set containing vacuum water bottle, pen and notebook - with matching color and premium soft touch feel.

Water bottle - Soft touch double walled vacuum insulated stainless steel water bottle with 5h hot & 10h cold - 500ml.

Pen - Soft touch metal pen with German Dokumental ink of 1200m writing length.

Notebook - Soft touch Hard Cover A5 notebook with 160 pages / 70GSM paper

(Bottle) Print Technique : UV, SC, ENG

(Notebook) Print Technique : UV, SC, EMB

(Pen) Print Technique : UV, SC, ENG

Preferred Print Location : Front

Preferred Print Location : Front

Preferred Print Location : Barrel

Max Print Size : 30 X 70 mm

Max Print Size : 210 X 140 mm

Max Print Size : 50 X 6 mm



# ECO GIFT SET

## Useful eco-conscious gift set with sustainable packaging:

**Notebook** - Kraft cover with FSC-certified paper inside

**Mug** - Wheatstraw material with silicone sleeve

**Pen** - Made with wheatstraw material

**VALUE**

READY STOCK



Wheatstraw Mug w/ silicone



Notebook with FSC paper



Wheatstraw Pen

- > All products plus packaging from sustainable materials
- > Silicone sleeve helps hold mug with hot liquid
- > 80 pgs Notebook - 14 x 9 cm, 70 gsm
- > Give VALUE, Save Ecology when you give out this set
- > 380 ml Mug capacity



GSEN 681 - KORGAN

(Notebook) Print Technique : SC, UV

(Pen) Print Technique : SC, UV

(Mug) Print Technique : SC

Box Size: 14.5 x 10.3 x 9.7 cm; Each set of 3 in box weighs 176 gms

Preferred Print Location : Front

Preferred Print Location : Clip

Preferred Print Location : Front

Max Print Size : 70 x 130 mm

Max Print Size : 7 x 35 mm

Max Print Size : 30 x 50 mm



  
Pierre Cardin  
PARIS



Legendary French designer, fashion designer and innovator Pierre Cardin. As a graduated architect he started his career of fashion designer after the Second World War under the guidance of a renowned master in the field, Mr Christian Dior.

In 1950 he sets up his own fashion saloon and in 1953 he becomes a member of the prestigious French association Chambre Syndicale de la Haute Couture. In 1959 he starts a revolution in the field by creating a first collection in history directly produced for the sale and wearing "prêt-à porter". In this way he brings high fashion to the general public.

Besides textiles and accessories Pierre Cardin designs furniture, interiors, objects of applied arts & has also worked for automobile and aircraft industry and in other areas.

Since 1991 Pierre Cardin has held the position of honorary ambassador of UNESCO and since 2009 he has been a good will envoy of the FAO of the United Nations.

Pierre Cardin has received a number of awards and decorations of high degree from institutions all over the world. Since 1977 he has several times been given De d' Or" (golden thimble), the largest honor of French haute culture. Pierre Cardin was the first fashion designer in history to win, in 1992, a chair in the French Academy of Fine Arts ( Academie des Beaux-Arts ).

The collection of original Pierre Cardin products has been carefully produced from selected materials and created with the emphasis on detail and attractive design.

History shows that Pierre Cardin is not only a fashion trademark, he is also a symbol of timelessness.



FEATURES :

- Smooth metal surface pen
- Clip with rubberised finish
- Blue roller pen refill with 0.5mm nib
- Comes with spare roller refill
- Geometric clip design



PBPC 101



READY STOCK

WIPC 743 - ARIES

Print Technique: UV, SC Preferred Print Location: Barrel  
Max Print Size: 30 x 5mm  
Packing Details : 48 X 45 X 31cm; 500 pcs/carton; gw/nw: 14.5 kg/carton



FEATURES :

- Clip action ballpoint metal pen
- Blue refill with 0.5mm nib
- Clip with spring action
- Simple and elegant

WIPC 705  
MARSEILLE

(Pen) Print Technique : UV, SC, ENG Preferred Print Location : Barrel  
Max Print Size : 30 x 6mm  
Packing Details : 34 X 28 X 19cm; 400 pcs/carton; gw/nw: 14 kg/carton



FEATURES :

- Clip action ballpoint pen
- Silver aluminium body
- Blue ballpoint refill with 0.5mm nib
- Fine PIERRE CARDIN engraving on surface
- Slim and light weight

WIPC 745  
MENTON

(Pen) Print Technique : UV, SC, ENG Preferred Print Location : Barrel  
Max Print Size : 30 x 4mm  
Packing Details : 48 X 45 X 31cm; 500 pcs/carton; gw/nw: 12.8 kg/carton



PBPC 103





WIPC 710



WIPC 746

Packaging



**FEATURES :**

- Endless usage, refillable notebook sleeve with modern PIERRE CARDIN pen and notebook
- 160 ruled pages; ivory color
- Back pocket to keep phone & cards
- PIERRE CARDIN bookmark

READY STOCK

**WIPC 710 - JURA**

(Notebook) Print Technique : UV, SC Preferred Print Location : Front  
 Max Print Size : 50 x 170 mm  
 (Pen) Print Technique : UV, SC, ENG Preferred Print Location : Barrel  
 Max Print Size : 30 x 8 mm Product size : 19 x 14 x 1.3 cm  
 Packing Details : 43 X 43 X 51 cm ; 40 pcs / carton ; gw / nw : 16kg / carton

**WIPC 746 - NORDEN**

(Notebook) Print Technique : UV, SC Preferred Print Location : Front  
 Max Print Size : 50 x 170 mm  
 (Pen) Print Technique : UV, SC, ENG Preferred Print Location : Barrel  
 Max Print Size : 30 x 8 mm Product size : 19 x 14 x 1.3cm  
 Packing Details : 43 X 43 X 51 cm ; 40 pcs / carton ; gw / nw : 16kg / carton

**FEATURES :**

- Modern fabric cover
- See-through phone pocket with modern PIERRE CARDIN pen
- Pockets to keep cards
- Phone/tablet stand
- PIERRE CARDIN ruled notepad included



**PNPC 702 - SARTHE**

( Folder) PrintTechnique : SC, ENG Preferred Print Location : Plate Max Print Size : 50 x 30 mm  
 ( Pen) Print Technique : UV, SC, ENG Preferred Print Location : Barrel Max Print Size : 30 x 6 mm  
 Product Size : 19 x 14 x 1.3 cm Packing Details : 59 X 28 X 35cm ; 25 pcs / carton ; gw / nw : 18 kg / carton



**BRAKEL**  
WIMP 446 - Black WIMP 447 - White WIMP 448 - Blue / Grey  
Giftology Twist action ballpoint metal pen. Blue ink  
Print Technique : UV, SC, ENG Preferred Print Location : Next to Clip  
Product Size : 13.8 x 1.1 cm

Max Print Size : 8 x 45 mm

READY STOCK



**GOSLAR**  
WIMP 449 - Black WIMP 450 - Blue  
Giftology Twist action ballpoint metal pen. Blue ink  
Print Technique : UV, SC, ENG Preferred Print Location : Next to Clip  
Product Size : 13.7 x 1.3 cm

Max Print Size : 8 x 40 mm



HONNEF

WIMP 5105 - Black WIMP 5106 - White

Giftology Twist action ballpoint metal pen. Blue ink

Print Technique : UV, SC, ENG

Preferred Print Location : Next to Clip

Max Print Size : 8 x 40 mm

Product Size : 14.3 cm Height

READY STOCK



ALSFELD

WIMP 5107 - Black WIMP 5108 - Silver

Giftology Twist action ballpoint metal pen. Blue ink

Print Technique : UV, SC, ENG

Preferred Print Location : Barrel

Max Print Size : 8 x 30 mm

Product Size : 14.3 cm Height



- > High Quality Ballpoint Pen
- > Sturdy Steel Exterior
- > Elegant Swiss Peak Sleeve



WISW 810 - LUZERN

**SWISS PEAK®** This ballpen is known by its quality and elegance. Comes with 1200m writing refill with German ink. Packed in Swiss Peak Sleeve.

Print Technique : ENG, SC Preferred Print Location : Next to clip  
 Max Print Size : 40 x 5 mm Product Size : 13.8 x ø1.0 cm  
 Packing Details :  
 18.0 x 34.0 x 54.0 cm ; 500pc /carton ; gw/nw: 10 kg / carton



- > High Quality Ballpoint Pen & Pencil
- > Sturdy Steel Exterior
- > Elegant Swiss Peak Gift Box



WISW 811 - LUZERN SET

**SWISS PEAK®** This pen set with ballpen and pencil is known by its quality and elegance. Comes with 1200m writing refill with German ink and pencil with 3 leads of 0.7 mm. Packed in Swiss Peak giftbox.

Print Technique : ENG, SC Preferred Print Location : Next to clip  
 Max Print Size : 130 x 100 mm Product Box Size : 2.5 x 24.5 x 32.5 cm  
 Packing Details :  
 30.0 x 39.0 x 49.0 cm ; 200pc /carton ; gw/nw: 12 kg / carton

READY STOCK



READY STOCK

**WISW 704 - RUNAPE**

**SWISS PEAK®** Unique styled pen with a luxury lined pattern on the barrel. This exclusive designed stylus ballpoint pen is an attractive, high quality gift. Including Swiss Peak tube giftbox. Blue ink.

Print Technique : SC, ENG Preferred Print Location : Barrel  
 Max Print Size : 47 x 5 mm Product Size : 14.0 x ø1.0 cm  
 Packing Details : 28 x 41 x 35 cm ; 300 pcs/carton; gw/nw: 14kg / carton

**WISW 705 - DUSCO SET**

**SWISS PEAK®** Authentic pen set bearing all the hallmarks of classic quality. High quality heavy brass metal rollerball with stylus and ball point pen with Swiss Peak branding. Including premium PU leather pouch and giftbox. Blue ink.

Print Technique : SC, ENG Preferred Print Location : Barrel  
 Max Print Size : 45 x 6 mm Product Size : 14.0 x ø1.1 cm  
 Packing Details : 53 x 39 x 36 cm; 100 pcs / carton; gw/nw: 17kg /carton



ANTI-BACTERIAL

- Tested for Anti-Bacterial effectiveness
- Soft Touch, Special mirror effect on engraving
- German Dokumental® Ink



Blue Red Black Green

BILLUND

WIMP 261 - Black WIMP 262 - Blue WIMP 263 - Red WIMP 264 - Green

Giftology Anti-Bacterial Metal Ballpoint pen with soft rubberized finish and matt gun metal trims. Especially designed for laser engraving, including a special coating for your logo. With 1200 m writing length and German Dokumental® Ink.

Print Technique : ENG, UV, SC Preferred Print Location : Barrel Max Print Size : 50 x 6 mm

Product Size : 13.7 x ø1 cm Packing Details : 34 x 29 x 16cm ; 500pcs /carton ; gw/nw: 9.5/10.5kg /carton

READY STOCK



- German Dokumental® Ink
- 1200m Writing Length
- Soft Touch, Special mirror effect on engraving



Black Black/Blue Black/Green Black/Red

VOJENS

WIMP 265 - Black WIMP 266 - Black/Blue WIMP 267 - Black/Red WIMP 268 - Black/Green

Giftology Ballpoint pen with twist mechanism, body in solid black color and stylus in a wide range of colors. Contrast Gun metal trims. Especially designed for laser engraving, including a special coating for your logo to be properly engraved in matching color with the stylus. With 1200 m writing length and German Dokumental® Ink.

Print Technique : ENG, UV, SC Preferred Print Location : Barrel Max Print Size : 50 x 6 mm

Product Size : 14.2 x ø1cm Packing Details : 34 x 29 x 16cm ; 500pcs /carton ; gw/nw: 9.5/10.5kg /carton



**MP 891 - VERTO**

XDDESIGN Verto is a set containing a ballpoint pen and a rollerball pen made from high quality brass, presented in a sliding box. The solid clip has spring function. Registered design®

Print Technique : UV, SC, ENG Preferred Print Location : Next to Clip  
 Max Print Size : 40 x 5 mm Packing Box Size : 14.5 x 20.5 x 2.7 cm  
 Packing Details : 65 x 44 x 32 cm ; 80 pcs /carton ; gw/nw: 20 kg / carton



**Kube Metal 4 In 1 Pen**

**KUBE**

WIXD 505 - Grey/White WIXD 506 - Grey/Blue

XDDESIGN Kube combines all your daily mobile needs in one stylus pen. The clip is designed to hold your mobile phone and clean your screen. The pen comes with a blue and black refill. Registered design®

Print Technique : UV, SC Preferred Print Location : Clip /Barrel  
 Max Print Size : 25 x 6 mm Product Size : 15 x 1.5 x 1.4 cm  
 Packing Details : 33.5 x 27 x 37 cm ; 160 pcs /carton ; gw/nw : 7.4 kg / carton

Phone Stand



Screen Cleaner



Stylus



**MP 895 - CURBA**

XDDESIGN Curba is a stainless steel ballpoint pen where round simplicity and finish makes the design. The pen can be refilled. Registered design®

Print Technique : UV, SC, Eng Preferred Print Location : Next to Clip  
 Max Print Size : W=35 x H=6mm Product Size : 14 x 1.2 cms  
 Packing Details : 38 x 36.5 x 27 cms ; 160 pcs /carton ; gw/nw: 7 kg / carton



**WIXD 501 - SPIN**

XDDESIGN Spin is a metal 360° ergonomic stylus pen with 6 clips so you can attach it anywhere you want. Delivered with extra refill. Registered design®

Print Technique : UV, SC, ENG Preferred Print Location : Barrel  
 Max Print Size : 30 x 5 mm Product Size : 14.5 x ø1.2 cm  
 Packing Details : 33.5 x 27 x 37 cm ; 160 pcs /carton ; gw/nw: 7 kg / carton

Scan Below QR code to watch product video

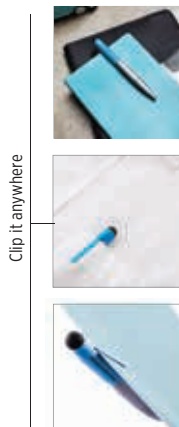

Clip it anywhere



Grey-White

Grey-Blue

Scan Below QR code to watch product video



**KONEKT**

WIXD 509 - Grey-White WIXD 510 - Grey-Blue

XDDESIGN Konekt brings a metal ballpoint pen and a rollerball pen closer together by connecting the clips. Both ballpoint pen and roller pen are delivered with black & blue refills. Registered design®

Print Technique : UV, SC, ENG Preferred Print Location : Next to Clip  
 Max Print Size : 70 x 6 mm Product Box Size : 16.5 x 4.9 cm  
 Packing Details : 44 x 27.5 x 38.5 cm ; 80 pcs /carton ; gw/nw : 7 kg / carton

READY STOCK



# METAL WRITING INSTRUMENTS



**WIGS 203 - TROFA**  
 Print Technique : UV, SC, ENG Preferred Print Location : Barrel  
 Print Size : 25 x 6 mm  
 Product Size : 13.8 x ø 1.1 cm  
 Packing Details : 39X 31.5 X 48.5cm; 200 pcs/carton; gw/nw: 15 kg/carton



**WIGS 202 - OSTEND**  
 Print Technique : SC, ENG  
 Preferred Print Location : Barrel  
 Max Print Size : 8 x 40 mm  
 Product Box Size : 17.2 x 6.4 x 2.9 cm



**WIMP 207 - DINANT**  
 Print Technique : SC, ENG Preferred Print Location : Barrel  
 Max Print Size : 8 x 40 mm Product Size : 13.5 x ø1.1 cm  
 Packing Details : 32 x 26 x 22 cm; 500 pcs/carton; gw/ nw: 14 kg/carton



**MONS**  
**WIMP 204 - Black    WIMP 205 - Blue    WIMP 206 - Red**  
 Print Technique : UV, SC, ENG Preferred Print Location : Barrel  
 Max Print Size : 10 x 50 mm Product Size : 13.6 x ø1.1 cm  
 Packing Details : 32 X 26X 22 cm ; 500 pcs /carton ; gw/nw: 13 kg / carton

READY STOCK





Black



Brown

Eco Recycled Leather adds elegance

KORU

WIEN 5110 - Black WIEN 5111 - Brown

eco-neutral Chrome metal pen with recycled leather barrel. Packed in a vintage recycled leather tube gift box. Blue ink

(Pen) Print Technique : UV, SC, ENG

Preferred Print Location : Next to Clip

Max Print Size : 40 x 8 mm

(On Leather Packaging) Print Technique : SC

Preferred Print Location : On Leather Packaging

Max Print Size : 150 x 15 mm

Product Size : 14 x 1.6 cm

READY STOCK



WIEN 5109 - ATCA

eco-neutral Elegant bamboo & chrome metal pen with clip. Packed in a matching metal / bamboo gift box.

Print Technique : UV, SC, ENG

Preferred Print Location : On Tube

Max Print Size : (On Tube) 100 X 4 mm; (On Pen Barrel) 40 X 3 mm

Product Size : 16.4 x ø2.5 cm (incl tube)



# WRITING INSTRUMENTS

READY STOCK



**WIMP 202 - DUON**  
 Print Technique : UV, SC, ENG Preferred Print Location : Barrel  
 Max Print Size : 8 x 40 mm Product Size : 14x ø1.25 cm  
 Packing Details : 35 x 35 x 18 cm; 300 pcs/carton; gw/ nw: 11 kg/carton



**Unique Hexagonal Body**      **German Dokumental® Ink**      **Swiss Tip**

VOGAR  
**WIMP 208 - Black**    **WIMP 209 - Blue**    **WIMP 210 - Pink**  
 Metal twist action pen. Including ca. 1200m writing length German Dokumental® blue ink refill with TC-ball for ultra smooth writing.  
 Print Technique : UV,SC,ENG Preferred Print Location : Barrel  
 Max Print Size : 65 x 8 mm Product Size : 13.8 x ø1.1 cm  
 Packing Details : 42X 32 X 19 cm ; 10.5 kg Pcs: 1000/ carton



**WIMP 213- GISTEL**  
 Print T : UV, SC, ENG    Print L : Next to clip  
 Max Print Size : 7 x 30 mm Product Size : 13,6 x ø1.1cm  
 Packing Details : 35 X 35 X 18 cm; 11 kg Pcs: 300/ carton



**WIMP 211 - LOMMEL**  
 Print T :UV, SC, ENG    Print L : Front & Back  
 Max Print Size : 7 x 30 mm Product Size : 13.6 x ø1.1 cm  
 Packing Details : 35 X 35 X 18 cm; 11 kg Pcs: 300/ carton



**WIMP 201 - VICHY**  
 Print Technique : UV, SC, ENG  
 Preferred Print Location : Barrel  
 Max Print Size : 8 x 40 mm  
 Product Size : 14x ø1.1 cm  
 Packing Details : 35 x 35 x 18 cm; 300 pcs/carton;  
 gw/nw: 11 kg/carton



The perfect accompaniment for the Legendary **MOLESKINE** Notebook !

Built to slide into your Moleskine Notebook



Classic Ballpoint pens

Classic Roller pens

Go Pens

Brushed Steel Clip



Black

White

Royal Blue

Black

White

OWMOL 353 - BLACK   OWMOL 354 - WHITE   OWMOL 351 - BLACK   OWMOL 352 - WHITE  
OWMOL 358 - ROYAL BLUE

The perfect match for the Moleskine notebook, Moleskine pens are designed specifically to clip onto the side of the classic hard cover.

Product Size : 14.5 x 1.5 x 1.3 cm

Packing Details : 40.2 x 12.4 x 18.8 cm ; 36 pcs /carton ; gw/nw: 1.25 kg / carton

- > Pens "Made In Italy"
- > Moleskine Ballpoint and Roller Pen Series
- > Clip The Moleskine Pen To Your Moleskine Notebook



White

Black

OWMOL 356 - WHITE   OWMOL 355 - BLACK

The perfect match for the Moleskine notebook, Moleskine pens are designed specifically to clip onto the side of the classic hard cover.

Product Size : 14.5 x 1.5 x 1.3 cm

Packing Details : 40.2 x 12.4 x 18.8 cm; 36 pcs /carton;

gw/nw: 1.25 kg / carton



Die Handschrift der Werbung

A Climate-Neutral Pens Factory in Germany

All **UMA** Pens are 100% Carbon Neutral



Supported offset project  
**Carbon offset + Regional nature conservation**  
**1t CO2 + Financial contribution**  
**International + Freiburg**



**2,636,777 kg CO<sub>2</sub>**  
have been offset



### Climate-neutral company

To ensure sustainable development, an important aspect for us is to take a holistic view of the three components: economics, environment and society. In collaboration with Climate Partner, our factory in Fischerbach, Germany is 100% climate-neutral – this includes the processing of all uma pens. The unavoidable emissions are compensated through climate protection projects. We consciously focus on investing in our region. The forest protection project in Freiburg aims to protect our valuable rural environment.

Facts:

- Emissions of 2,636,777 kg CO<sub>2</sub> compensated to date
- 100% climate-neutral processing in Fischerbach
- 25 UMA product collections manufactured, processed and delivered climate-neutrally



- Executive Uma set with unique mesh barrel
- German-made Uma refills that lasts upto 10,000 meters of flawless writing
- Packed in an elegant gift box with sleeve

**WIGS 5122 - BLACK FOREST**

Black Forest is a premium gift set of 2 award-winning mesh design metal pens from Uma - made in Germany. The set contains a rollerball and a ballpoint pen with glossy lacquered finish and an integrated mesh band on the barrel. The set also contains an added German-made Dokumental ink refill for each pen. Packed in a premium magnetic gift box with sleeve.

Print Technique : SC      Print Location : On Gift Box      Max Print Size : 219 x 150 mm  
Product Size : 22 x 15 x 2.7 cm



➤ Luxurious Stone look Pens



Dark Grey      Light Grey

**LUMOS STONE**

**WIMP 444** - Light Grey    **WIMP 445** - Dark Grey

Retractable metal ballpoint pen with reconstructed concrete or stone look and touch. Metal clip and push button matt chromed. From UMA- a Climate-Neutral Certified factory in Germany.

Print Technique : UV, SC      Print Location : Next to Clip      Max Print Size : 3 x 30 mm

**READY STOCK**



Climate neutral certified  
Elegant Soft-touch  
Engraving reveals beautiful lacquered metal underneath

READY STOCK

LUMOS GUM

WIMP 5112 - Black WIMP 5113 - Grey WIMP 5114 - Dark Blue WIMP 5115 - Light Blue WIMP 5116 - Red WIMP 5117 - Dark Green  
WIMP 5118 - Light Green WIMP 5119 - Purple

Lumos GUM by Uma is a metal retractable ballpoint pen with soft touch housing. Metal clip and push-button matt chromed.

Manufactured in The Black Forest, Germany, all Uma pens are climate-neutral certified

Print Technique : UV, SC, ENG Print Location : Next to Clip Max Print Size : 3 x 30 mm

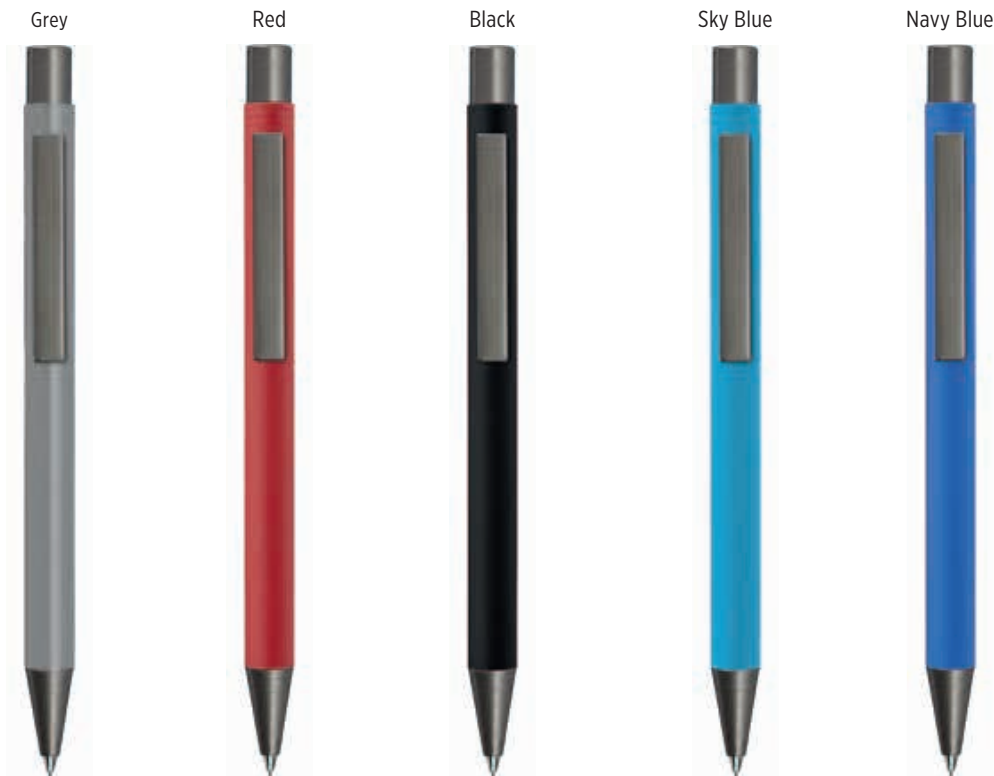

Packing: PB 1053

MP 921 - STRAIGHT

UMA Metal Pens from germany

Print Technique : UV, SC, ENG

Product Size : 14 X ø1.2 cm

Print Location : Next to Clip

Box Size : 3 X 16.2 X 1.2 cm

Max Print Size : 30 x 5.5 mm

Packing Details : 39 X 24 X 30cm; 1000 pcs /carton; gw/nw: 18.5 kg/carton



**PP 251 - ULTIMATE**

Print Technique : UV, SC      Print Location : Barrel  
Max Print Size : 40 x 6 mm      Product Size : 14.4 x ø1.2 cm  
Packing Details : 39 X 29 X 24 cm ; 1000 pcs / carton ; gw /  
nw : 14.5 kg / carton



**PP 291 - KYOM**

**UMA** Retractable ballpoint pen with metal clip & pusher in silver matt

Print T. UV, SC    Print L. Barrel  
Max Print Size : 40 x 5.5 mm  
Product Size : 14 x ø1.2 cm



**PP 244 - CHILL**

**UMA** Twist ballpoint pen with shiny solid colored body, heavy, matt chrome metal tip and metal clip

Print T. UV, SC    Print L. Barrel  
Max Print Size : 40 x 6 mm  
Product Size : 14.5 x ø1.3 cm

READY STOCK



\* Look for the **UMA** brand on the pen

**HAPPY**

**WIPP 601** - Black    **WIPP 602** - White    **WIPP 603** - Grey    **WIPP 604** - Royal Blue  
**WIPP 605** - Aqua Blue    **WIPP 606** -Red    **WIPP 607** - Green    **WIPP 608** -Purple    **WIPP 609** - Orange

**UMA** Ballpoint pen with tungsten carbide ball ( 1mm) & 2200 linear meter writing length.

Print Technique : UV, SC      Preferred Print Location : Clip      Max Print Size : 35 X 7 mm  
Product Size : 13.8 x ø1 cm



**PP 235 - PENNY FROZEN**

**UMA** Retractable ballpoint pen with white barrel and colored frosted clip

Print T. UV, SC    Print L. : Barrel  
Max Print Size : 40 x 6 mm  
Product Size : 14.5 x ø1.3 cm  
Packing Details: 40 X 28 X 39 cm;  
2000 pcs / carton; gw / nw : 20.5 kg / carton



# WRITING INSTRUMENTS



Purple



Green



### PP 242 - STRIPE

**UMA** Retractable ballpoint pen in white with transparent frosted soft-grip zone, fitting and clip shell

Print T. UV, SC Print L.: Barrel

M. Print Size : 40 x 6 mm

Product Size : 14.5 x ø1.3 cm

Packing Details: 39 X 29 X 34 cm;

1000 pcs / carton; gw / nw : 11 kg / carton



Red



### PP 240 - SPEED

**UMA** Retractable ballpoint pen with solid -colored transparent frosted barrel and clip, and silver retractable cap

Print T. UV, SC Print L.: Barrel

Max Print Size : 40 x 4 mm

Product Size : 15 x ø1.3 cm



### PP 243 - FANTASY

**UMA** Retractable ballpoint pen with soft- grip zone and push-button clip

Print T. UV, SC Print L. Barrel

M. Print Size : 40 x 4 mm

Product Size : 14.5 x ø1.3 cm



### PP 243 - FLAG

**UMA** This pen from UMA-Germany represents the national flag colours of some Middle Eastern countries.

Print T. UV, SC Print L. Barrel

M. Print Size : 40 x 4 mm

Product Size : 14.5 x ø1.3 cm

READY STOCK

### Available Colors

Black Grey Navy Blue Orange Yellow



### German Dokumental® Ink

All White White/Blue White/Red

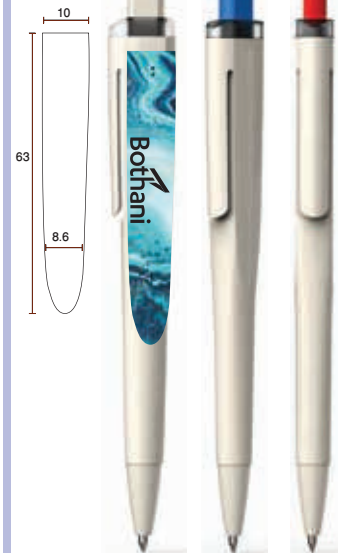

### ELVAS

WIPP 812 - All White WIPP 813 - White/Blue

WIPP 814 - White/Red

Print Technique : UV, SC

Preferred Print Location : Next to clip

Max Print Size : 10 x 63 mm

Product Size : 13.1 x ø1.1 cm

Packing Details : 50X 33 X 22 cm ;

9 kg Pcs: 1000/ carton

### DORFEN

WIPP 824 - Black WIPP 825 - Grey WIPP 826 - Navy Blue WIPP 827 - Orange WIPP 828 - Yellow

Soft touch (rubberized finish) plastic pen with geometric design. Blue ink.

Print Technique : UV, SC

Preferred Print Location : Front Max Print Size : 50 x 12 mm

Product Size : 31.6 x 5.5 x 4 cm

Packing Details : 35.5 x 38 x 15.5 cm; 10 pcs/carton; gw/nw: 5 kg/carton





**Light-Up Your Brand**



**DURBUY**  
 Blue Black  
**WIPP 201** - Black **WIPP 202** - Blue  
 Ballpen with twist open mechanism that lights up the barrel when you twist to open. Stylus on top.  
 Print T.: UV, SC, ENG Print L.: Barrel  
 M. Print Size: 10 x 50 mm Product Size: 13.5 x ø1.2 cm  
 Packing Details: 58 x 16 x 24 cm; 500pcs/carton;  
 gw/nw: 7.5 kg / carton

**Light-Up-Logo**

**Touch Ball & Light Color Match**



**KENDARI**  
 Blue Orange Yellow  
**STMK 121** - Blue **STMK 123** - Orange **STMK 125** - Yellow  
 Led pointer ball pen with twist mechanism.  
 Print Technique: SC, ENG Print Location: Barrel  
 Max Print Size: 30 x 6 mm Product Size: 14.2 x ø1.3 cm  
 Packing Details: 24 x 32 x 53 cm; 1000pcs /carton;  
 gw/nw: 14.5 kg / carton



**Special Laser Engraving Logo**

These pens have an outer coating specially designed for laser engraving which ensures brand color in mirror finish & matches the pen.



**BINJAI**  
**STMK 150** - Blue  
 Ball pen with push-up mechanism, body in black solid color and upper ring in a wide range of matte, metallic colors. Black color clip and a wide printing area on barrel especially designed for laser engraving, including a special coating for your logo to be properly engraved in matching color with the upper ring. Jumbo cartridge and blue ink.  
 Print Technique: ENG Preferred Print Location: Barrel  
 Max Print Size: 50 x 6 mm Product Size: 13.9 x ø1 cm  
 Packing Details: 18 X 16 X 42.5 cm; 500 pcs /carton;  
 gw/nw: 8 kg / carton

READY STOCK



**STMK 135** - CIMAHI  
 Micrometer ball pen with twist mechanism. With built-in ruler of 10cm. Blue ink.  
 Print Technique: SC  
 Print Location: Right and Left Sides  
 Max Print Size: 50 x 7 mm  
 Product Size: 1.1 x 14.8 cms  
 Packing Details: 32 x 22 x 43 cms;  
 1000pcs /carton; gw/nw: 8.5 kg / carton

**Swiss Tip German Ink**

Pink Aqua Blue



**WIPP 751** - Aqua Blue  
**WIPP 755** - Pink  
 Print T.: UV, SC  
 Print L.: Clip  
 Max Print Size: 25 x 4 mm  
 Product Size: 13.5  
 Packing Details: 48 X 31 X 20 cm; 1000 pcs/carton;  
 gw/nw: 9 kg/carton

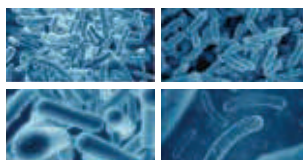

- > Treated with Japanese Antibacterial agent produced with SIAA Member
- > Great Branding Space on clip



**WIPP 820** - LEOVA  
 GiftologyPen is an object that every person keeps using and sharing. Sharing a pen means also transferring disease causing bacteria. Worried? Dont be! Because this pen is made from antibacterial agents produced with SIAA mark. With 99% Bacteriostatic Rate, these pens prevent growth and multiplication of bacteria on their surface.  
 Print Technique: SC, UV Preferred Print Location: Clip  
 Max Print Size: 35 X 7 mm Product Size: 14 x ø1cm  
 Packing Details: 54x 34 x 18 cm; 500 pcs /carton;  
 gw/nw: 5/4 kg /carton



- > Treated for bacterial effectiveness
- > 1200m writing length
- > German Dokumental® Ink.



**DEPOK**  
**WIPP 822** - Blue  
 Giftology Carbon pattern click action ballpoint pen that is treated with Antibacterial Silver-Ion technology in accordance with ISO 22196. With 1200 meter writing length and German Dokumental® Ink.  
 Print Technique: UV, SC Preferred Print Location: Clip  
 Max Print Size: 8 X 35 mm  
 Product Size: 14 x ø1cm



# WRITING INSTRUMENTS



WIMP 269 - ULMEN

Giftology Black metal pen with bamboo clip

Print Technique : UV, SC, ENG

Preferred Print Location : On Bamboo

Max Print Size : 30 x 5 mm

Product Size : 14 x 1.5 x 1.2 cm

READY STOCK



White

Blue

Black

Green

Orange

Pink

KUPANG

STMK 105 - White STMK 106 - Blue STMK 107 - Black STMK 109 - Green STMK 110 - Orange  
STMK 111 - Pink

Stylish ball pen with quadrangular body in frosted finishing. Push-up mechanism, original clip and available in a wide range of vivid colors. Blue ink refill.

Print Technique : SC, UV

Preferred Print Location : Barrel

Max Print Size : 50 x 4 mm

Product Size : 1 x 14.5 x ø0.8 cm

Packing Details : 28 x 28 x 55 cm ; 2000 pcs / carton ; gw / nw : 13 kg / carton



Heart

Wink

ARCATA

STMK 143 - Heart STMK 146 - Wink

Ball pen with fun emoji designs in eye-catching yellow color. With push-up mechanism, soft body in glossy finish and original circular clip. Blue ink.

Print Technique : SC

Preferred Print Location :

Max Print Size : SC, 50 x 5 mm

Product Size : 14 x ø0.9 cm

Packing Details : 35 x 51 x 51 cm ; 1000 / carton ;

gw / nw : 12.5 kg / carton



5-IN-1

- > Pen
- > Spirit Level
- > Ruler (7 cm)
- > Screw Driver
- > Stylus Tip
- > Solid Bamboo

eco-neutral



WIEN 876 - WILTZ

**eco-neutral** Multifunction bamboo pen with ruler (7cm) , spirit level, stylus tip and ballpoint. Made from bamboo with aluminium clip. German Documental Ink (Blue)

Print Technique : UV, SC, ENG Preferred Print Location : Barrel Max Print Size : 25 X 10 mm  
 Product Box Size : 2.3 x 5.3 x 17 cm Packing Details : 27 x 31 X 37 cm ; 100 pcs / carton ; gw / nw : 15.5 kg / carton

READY STOCK



- > Sustainably made bamboo eternity pencil
- > Replaces 100 traditional wooden pencils



WIEN 877 - ETERNITY

**eco-neutral** Bamboo eternity pencil replaces your traditional wooden pencil. Traditional wooden pencils write only up to around 200 metres, but this bamboo eternity pencil, has a writing length of up to around 20,000 metres using a graphite tip to produce a graphite line. Not only does it write like a pencil, but the markings can be erased. It works by leaving a graphite line on paper just like a regular traditional wooden pencil but it wears down so slowly, that it should outlast up to 100 traditional wooden pencils!

Print Technique : UV, SC, ENG Preferred Print Location : Front Max Print Size : 100 X 4 mm  
 Product Size : 14.5 x ø1 cm



## BAMBOO (ECO) PENS



- Fun Colours
- Matching Stylus
- Bamboo Grip
- Metal Pen



READY STOCK

AYTOS

WIMP 871 - Black WIMP 872 - Grey WIMP 873 - Blue WIMP 874 - Green

**eco-neutral** Elegant combination of young & corporate colors with bamboo grip

Print Technique : UV, SC, ENG Preferred Print Location : Barrel Max Print Size : 25 X 10 mm

Product : 14.5 x ø1cm Packing Details : 27 x 31 X 37 cm ; 100 pcs / carton ; gw / nw : 15.5 kg / carton

## eco-neutral

Natural

Blue

Green

Wheat Straw Trims



Bamboo Body



SERANG

WIEN 101 - Natural WIEN 102 - Blue WIEN 103 - Green

**eco-neutral** Eco-Friendly push-up mechanism ball pen. Body in bamboo, with accessories in wheat straw, to encourage the use of natural raw materials.

Print Technique : UV, SC, ENG Preferred Print Location : Barrel Max Print Size : 6 x 50 mm

Product Size : 14 x ø1 cm Product Size : 15 x ø1 cm Product Size : 16 x ø1 cm

Packing Details : 48 x 31 x 22 cm ; 1000 pcs / carton ; gw/nw : 9.5 kg / carton





FO 3340 - JUDAS

A4 folder with a button closure made from Eco-friendly material. Consists of a notepad with 40 pages, pen loop and pocket to keep documents and business cards.

Print Technique : SC Preferred Print Location : Top Right Max Print Size : 130 x 100 mm  
 Product Size : 23.5 x 32.5 x 1.5 cm Packing Details : 52 x 38.5 x 35 cm; 40 pcs/carton; gw/nw: 14.5 kg/carton



FO 3341 - SORBUS

A4 folder with a button closure made from Eco-friendly material. Consists of a notepad with 70 pages, a pocket to keep documents and business cards.

Print Technique : SC Preferred Print Location : Center Max Print Size : 300 x 140 mm  
 Product Size : 22.5 x 31.5 x 2 cm Packing Details : 51 x 35 x 34.5 cm; 30 pcs/carton; gw/nw: 17kg/carton

READY STOCK

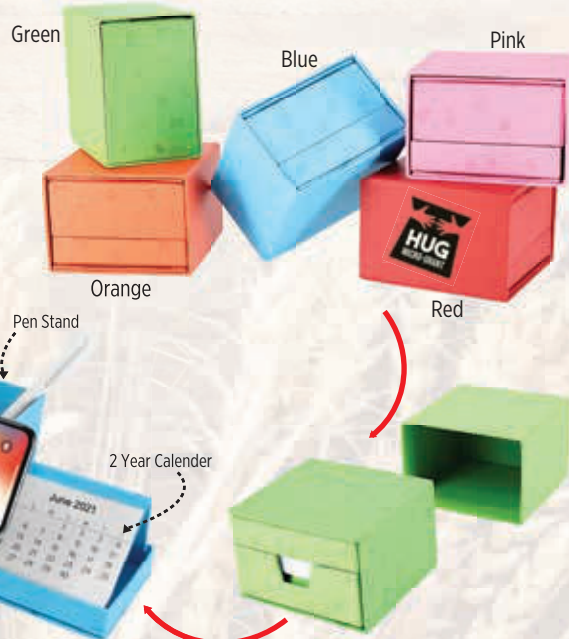

KALMAR

EFEN 210- Blue EFEN 211- Green EFEN 212- Red EFEN 213- Pink EFEN 214- Orange

**eco-neutral** Kalmar is a smart box that unfolds into a useful desk tool. Consists of a pen holder, 150 notepad pages, sticky notes in 5 different colors (25 sheets per color), a 2 year calendar and a secret box to keep those small things you want to hide from the world!

Print Technique : SC, UV Preferred Print Location : Front Max Print Size : 70 x 60 mm  
 Product Size : 10.5 X 10.5 X 7 cm



READY STOCK





Grey



Black

**SAY NO TO GREENWASHING**

**Tell the true story of sustainability with genuine recycled rPET**

Certified by



**GIFTS THAT GIVE BACK**

785 million people - 1 in 9 - lack access to safe water. We are supporting Water.org to change this.

For each CHANGE product sold, **3% of sales is donated** by the brand owners to Water.org to save lives with safe water and sanitation



READY STOCK



- Trendy 2-in-1 design for laptop sleeve and workstation
- Lifts laptops 6 cms for better work comfort
- Versatile pockets in the back
- Portable and easy to carry
- Uses high quality magnets for the cover and laptop stand



FULDA

LSSN 411 - Black LSSN 412 - Grey

SANTHOME Santhome Fulda - CHANGE Collection 15.6" Laptop Case & Workstation is a trendy and practical 2-in-1 laptop sleeve and workstation made from GRS-certified RPET and stylish faux leather. The laptop sleeve easily converts into a mobile office with laptop stand so you can work anywhere comfortably. Stay organised with the additional sleeve pockets and pen loops that allows you to take your other office essentials with you. Each recycled bag saves 2.5L of water, reuses 3 plastic bottles and makes an impact by contributing to Water.org - a global NGO that provides millions in need with access to safe water and sanitation. By giving to Water.org, you are giving a GIFT THAT GIVES BACK.

Print Technique : SC

Preferred Print Location : Front

Max Print Size : 120 x 100 mm

Product size : 27 X 16 X 7 cm



# PORTFOLIOS & ORGANIZERS

## BALMAIN PARIS

A4



FO 3287

BALMAIN Stylish designed portfolio with zipper closure, pen loop, ringbinde and several pockets to store your documents. Accessories not included  
Print Technique : UV, ENG, SC Preferred Print Location : Bottom Center Max Print Size : 90 x 305 mm  
Product Size : 27x 34 x 2.5 cm Packing Details : 53 x 32 x 37 cm; 12 pcs/carton; gw/nw: 10.5 kg/carton

## Hans Larsen™

5"



READY STOCK

FO 3232 (5") - OLAME

Hans Larsen™ PU organizer with white contrast stitch and magnetic closure. 6-ring binder allows you to turn the pages easily. Inside flap allows for keeping documents, 3 credit cards and identity card/business card.  
Print Technique : SC Preferred Print Location : Bottom Centre Max Print Size : 40 x 40 mm  
Product Size: 10.5 x 14.5 x 2.5 cm Packing Details : 44 x 30 x 31 cm; 40 pcs/carton; gw/nw: 9.4 kg/carton

## Hans Larsen



Blue

Grey



Black

7"



FO 3346(7") - SOMEL

Hans Larsen™ PU organizer with a textured cover. 6-ring binder allows you to turn the pages easily. Inside flap allows for keeping documents, a pen, 3 credit cards and identity card/business card. Always keep yourself organized! ( Pen not included )  
Print Technique : ENG, EMB, SC Preferred Print Location : Bottom Center Max Print Size : 90 x 180 mm  
Product Size : 12.5 x 19 x 3.5 cm Packing Details : 56 x 34 x 21 cm; 40 pcs/carton; gw/nw: 14 kg/carton





QUALITY

# VANCOUVER



- > Mobile Office
- > Practical Pockets On Outside & Inside

- > Notebook Included
- > Fits Tablets Upto 10 Inches

READY STOCK

**VANCOUVER**

ITXD 601 - Grey ITXD 602 - Blue

XDDESIGN Vancouver makes it possible to work from anywhere. It's a compact yet multifunctional solution with pockets on both the outside and inside for all your daily necessities. The strong velcro secures all your belongings. There is a dedicated tablet pocket (max 10" tablets) with soft inside to protect your screen. This pocket can be transformed quickly to stand your tablet and you are ready to start working. The fabric portfolio comes with an A5 notebook with 64 cream pages of 70g/m2. Registered design®

Print Technique : SC, HT  
Product Size : 30.9 x 24 x 2.5 cm

Preferred Print Location : Front Max Print Size : 240 x 60 mm  
Packing Details : 28 x 51 x 33 cm; 20 pcs/carton; gw/nw: 16 kg / carton

## XD

- > A4 Portfolio
- > Front Sleeve With Utility Pockets
- > Includes Recycled A4 Notepad



A4



**PNXD 820 - OBAN**

XD Oban is an A4 portfolio with 2 useful front pockets for mobile phone and cards. Also a larger pocket can be used to keep documents. Inside sleeve for documents, 4 card holders and pen loop. Polybag packing.

Print Technique : SC, EMB Preferred Print Location : Front Up Max Print Size : 120 x 80 mm  
Product Size : 23.5 x 31 x 2 cm Packing Details : 32.5 x 25 x 43 cm; 20pc /carton; gw/nw: 11.12 kg / carton



# CUSTOMISED DIARIES

### A5 Daily Diary



Cream Paper



White Paper

### Mini Executive Diary

CUSTOM MADE



Cream Paper

### Executive Weekly Diary



Cream Paper

### Mini Executive Weekly Diary



Cream Paper

### A4 Daily Diary



Cream Paper

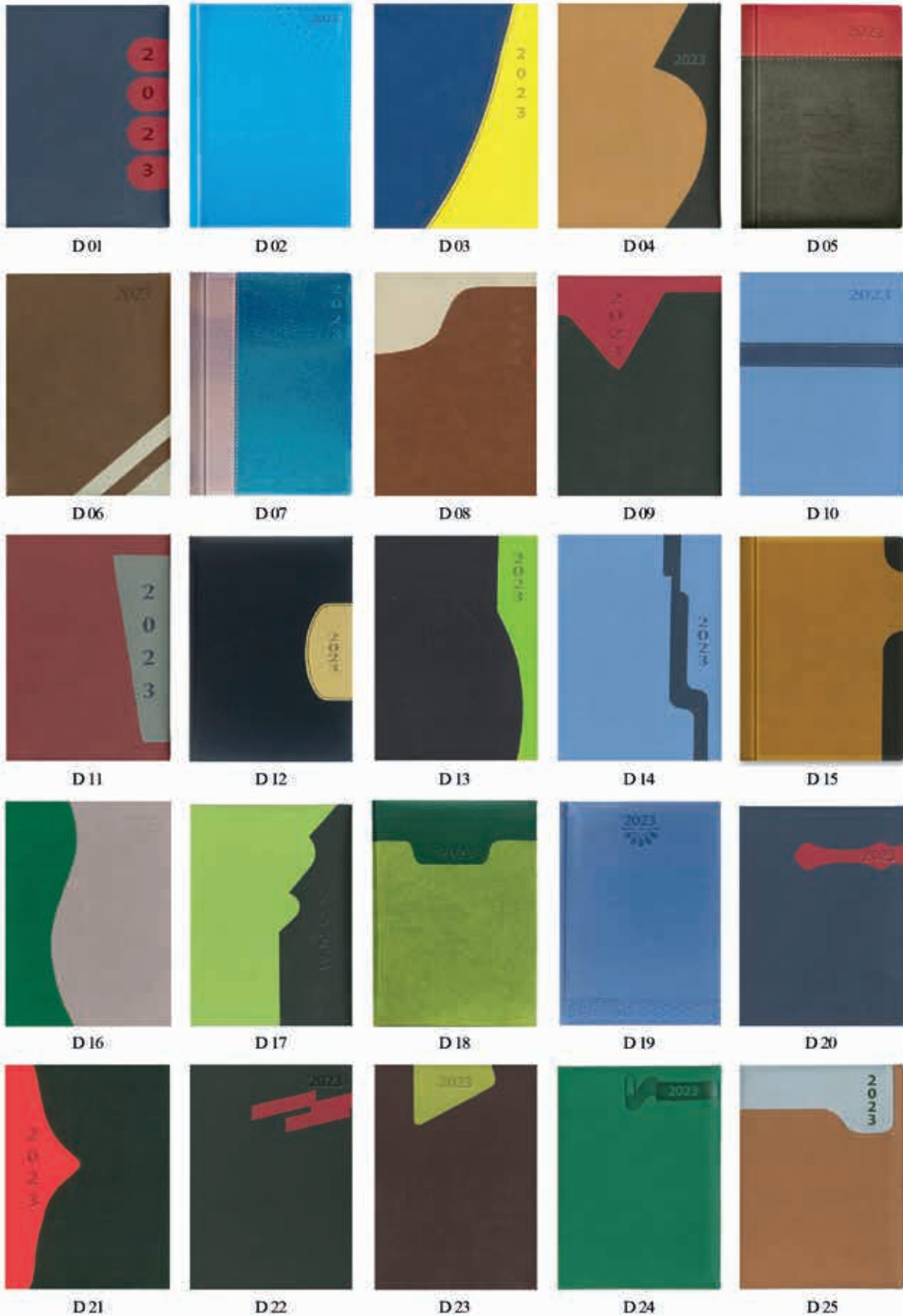

CUSTOM MADE

Customised Diaries - Check out our new covers on the previous page & on this one. The A5 & the Executive Daily continue to be the most popular versions users like.



**C-secure** RFID Protection





**Genuine Leather**



Chestnut

Mogano

Solis



Black



Cobalto

**MARALIK**

LASN 639 -Black LASN 640-Cobalto LASN 641-Chestnut LASN 642-Mogano LASN 643-Solis

No more electronic pickpocketing, broken or bent cards! This is the ultimate wallet for the regular card user. The XL cardholder in Genuine Italian Leather can hold up to 12 cards. The side button slider will push the cards up gradually. The wallet can hold your cash or more cards.

Product size : 9.5 x 6.7 x 1.2cm Packing Details : 45.5 x 27 x 21 cm ; 50 pcs /carton ; gw/nw: 5.8/7.0 kg / carton

**READY STOCK**



Black



Navy Blue



Brown

**VATRA**

LASN 631 - Black LASN 632 -Navy Blue LASN 633 - Brown

No more electronic pickpocketing, broken or bent cards! This is the ultimate wallet for the regular card user. The XL cardholder can hold up to 12 cards. The side button slider will push the cards up gradually. The wallet can hold your cash or more cards.

Product size : 10 x 7 x 2.5 cm Packing Details : 45.5 x 27 x 21 cm ; 50 pcs /carton ; gw/nw: 5.8/7.0 kg / carton



**c-secure**





Brown

Navy Blue

Black

OTACI

LASN 634 - Black LASN 635 - Navy Blue LASN 636- Brown

No more electronic pickpocketing, broken or bent cards! This is the ultimate wallet for the regular card user. The XL cardholder can hold upto 12 cards. The side button slider will push the cards up gradually. The wallet can hold your cash or more cards. Also features a coin pocket on the back.

Product size : 10 x 7 x 2.5 cm Packing Details : 45.5 x 27 x 24 cm ; 50 pcs /carton ; gw/nw: 6.5/9.0 kg / carton

READY STOCK



Silver

Black

CODRU

LASN 637 - Black LASN 638 - Silver

No more electronic pickpocketing, broken or bent cards! This is the ultimate wallet for the regular card user. The XL cardholder can hold up to 12 cards. The side button slider will push the cards up gradually.

Product size : 9.5 x 6.7 x 1.2cm Packing Details : 43 x 27 x 22 cm ; 100 pcs /carton ; gw/nw: 6.5/9.0 kg / carton



PRESENTING A WALLET THAT PROTECTS AGAINST FRAUD IN THE NEW WI-FI ERA.

# SANTHOME SECURITY FOR YOU

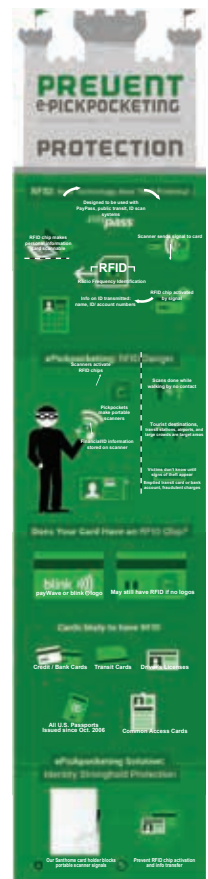

### How the card holder protects?

The aluminium Cardprotector protects your most important plastic cards not only against bending and breaking, but also against malicious parties reading your RFID and NFC cards. RFID (Radio Frequency Identification) cards contain a chip and an antenna for wireless communication. Examples of RFID cards include the Travel card, ID cards, the latest generation of credit cards and bank cards, as well as various access passes.

### Using the Cardprotector

The Cardprotector can hold a maximum of 7 cards. If only embossed cards are used, the capacity is 5 cards. Position the cards you use the most at the back or front and they will slide out sufficiently to be used. Slide out the cards with ONE movement of the slider on the side. The radio signal, although still greatly reduced, will now be sufficient for contact over a short distance. This means that you can use your RFID-NFC cards easily and securely. After use, slide your cards back into the Cardholder by pressing down on them lightly.

READY STOCK



Packaging



- > Rfid Protection Card Holder
- > Slide-Open Mechanism

LASN 607 - KLOY

SANTHOME Cardholder with RFID protection. Designed in Europe.

Print Technique : SC, UV, ENG Preferred Print Location : Front Top  
Max Print Size : 58 X 74 mm Product Size : 9.5 x 6.2 x 0.8 cm  
Packing Details : 42.6 x 25.3 x 38.3 cm; 100 pcs /carton ; gw/nw: 13.6 kg / carton

RFID BLOCKING



Pink



Camel



Packaging

- > Rfid Protection Wallet
- > Slide-Open Mechanism
- > Designed In Europe



Scan Below QR code to watch product video



VITL

LASN 603 - Pink LASN 604 - Camel

SANTHOME Cardholder cum Wallet with RFID protection . Designed in Europe.

Print Technique : SC, UV, ENG, EMB Preferred Print Location : Front Top  
Max Print Size : 50 x 50 mm Product Size : 7 x 9.8 x 2 cm  
Packing Details : 42.6 x 25.3 x 20.7 cm ; 50 pcs /carton ; gw/nw: 8.5 kg / carton





**SANTHOME**  
GENUINE LEATHER



Box: PB1041



CH 151 - LITHIS

**SANTHOME** Metal cardholder with Genuine grained leather covering. Can hold up to 20 Business Cards. Packed in a velvet pouch and presented in a textured two piece box.

Print Technique : ENG Preferred Print Location : Front Bottom  
Max Print Size : 40 x 30 mm Product Size : 6 x 10 x 1 cm  
Packing Details : 59.5 x 25 x 32 cm ; 200 pcs /carton ; gw/nw: 23.2 kg / carton

**SANTHOME**  
GENUINE LEATHER



6003 - UTTUN

Print Technique : ENG, EMB, FO Preferred Print Location : Front Bottom Right  
Max Print Size : 25 x 55 mm Product Size : 7 x 10.5 x 1 cm

READY STOCK

Giftology



MTGL 803 - TETOVO

Giftology RFID secured case that sticks to the back of your phone and can also be used as a phone stand or phone grip.

Print Technique : SC, UV Preferred Print Location : Front  
Max Print Size : 65 x 20 mm Product Size : 8.8 x 5.8 cm  
Packing Details : 31.5 X 21.5 X 54 cm ; 500 pcs/carton; gw/ nw: 13 kg/carton

eco-neutral



Dark Grey Exterior



Light Grey Exterior



CH 139 - TRAILL

eco-neutral Pocket Cards Holder in attractive color combinations with eco-friendly felt jacket

Print Technique : SC Preferred Print Location : Center  
Max Print Size : 50 x 90 mm Product Size : 8.5 x 11 x 1 cm  
Packing Details : 54.5 x 27 x 30.5 cm; 200 pcs/carton; gw/nw: 7 kg/carton



# RFID CARDHOLDERS & GIFT SET

## Giftology



CHGL 803 - SNEEK

Giftology Grained PU leather cardholder with anti-skimming RFID protection. Can hold up to 10 cards. Features a bill pocket. Packed in a gift box.

Print Technique : SC, ENG, UV Preferred Print Location : Front  
Max Print Size : 40 x 70 mm Product Size : 7 x 9.8 x 2 cm  
Packing Details : 42 x 31.5 x 24.5cm ; 100 pcs /carton ; gw/nw: 11 kg / carton



MANADO

ITMK 119 - Red ITMK 120 - Green ITMK 121 - Orange

Witty design cardholder with Slide and Remove mechanism. RFID (Radio Frequency Identification) security technology that keeps card data safe. Capacity up to 5 cards, in a wide range of vivid colors.

Print Technique : SC, UV Preferred Print Location : Front  
Max Print Size : 70 X 45 mm Product Size : 6.2 X 10 X 1.1 cm  
Packing Details : 34 X 26 X 58 cm ; 16 kg Pcs: 500/ carton

- Easy Pull-Up Mechanism to Remove Cards
- Excellent Branding Space
- RFID Security Technology

## XD COLLECTION



- RFID Protection
- Great Logo Space
- Easy Access Opening
- Value Proposition !

ITXD 727 - SMART CARD

XD Slim down your wallet with this elegant minimalistic wallet design. The wallet can hold up to 8 credit cards. Ideal for credit cards, bills and business cards. With anti-skimming protection. It blocks 100% of all known RFID/NFC frequencies.

Print Technique : SC, UV Preferred Print Location : Front  
Max Print Size : 65 x 40 mm Product Size : 8.8 x 5.8 cm  
Packing Details : 39 X 25 X 42 cm ; 500 pcs/carton; gw/nw: 16.02 kg/carton



PADANG

ITMK 114- Black ITMK 115- Red ITMK 116- Blue

Card holder with RFID blocking technology to protect your cards from identity theft, breaking and damage. Can hold up to 12 cards.

Print Technique : SC, UV, ENG Preferred Print Location : Front  
Max Print Size : 50 x 25 mm Product Size : 8.9 x 5.8 x 0.7 cm  
Packing Details : 19 X 27 X 42 cm ; 13.5 kg Pcs: 400/ carton

READY STOCK



- Keychain
- Manicure Set

GSBG 915 - MANIKE

Gift set consisting of a manicure set and a keychain. Manicure set consists of Nail filer, Cuticlepusher, Nail clipper and toe nail Clipper. Packed in a nice gift box.

(Box) Print Technique : SC, UV Preferred Print Location : Front Plate Max Print Size : 35 x 10 mm  
(Keychain) Print Technique : SC, UV, ENG Preferred Print Location : Front Max Print Size : 30 x 30 mm  
(Manicure Set) Print Technique : SC, UV, ENG Preferred Print Location : Front Max Print Size : 90 x 40 mm  
Product Box Size : 14 x 16 x 3 cm Packing Details : 34 X 29 X 38.5cm; 40 pcs/carton; gw/nw: 10.3 kg/carton

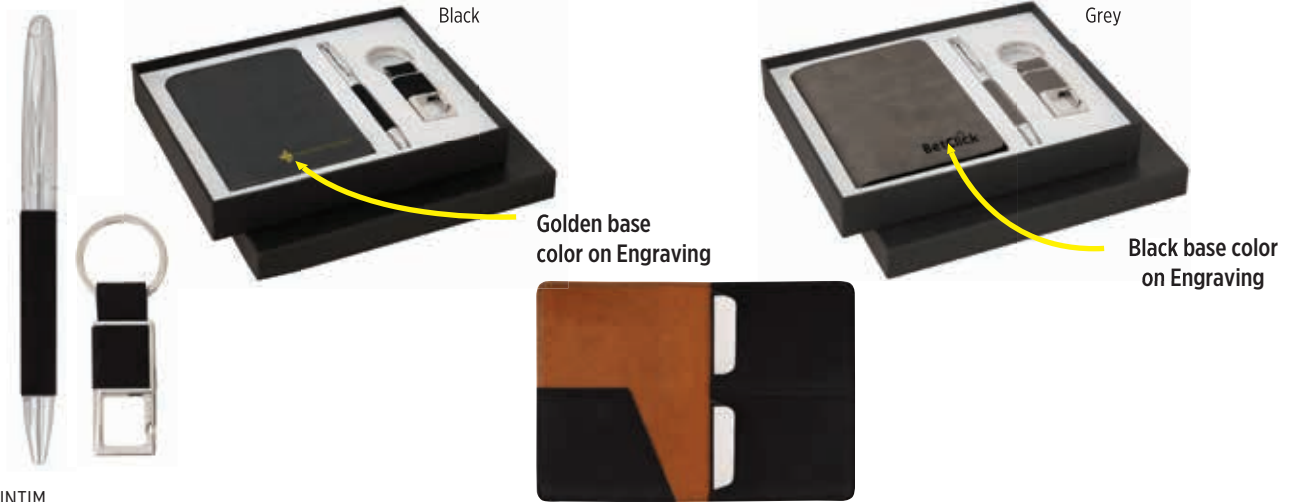

**PINTIM**

**GSGL 103** - Black **GSGL 104** - Grey

**Giftology** Pintim is a gift set consisting of coarse grained passport holder, a metal pen and a metal key chain. Its modern material is such that on engraving, golden color comes up in black and black color come up in grey. Packed in an elegant gift box.

(Passport Holder) Print Technique : FO, ENG, EMB	Preferred Print Location : Front Bottom	Max Print Size : 80 x 120 mm
(Pen) Print Technique : SC, ENG	Preferred Print Location : Barrel	Max Print Size : 35 x 7 mm
(Key Chain) Print Technique : SC, ENG	Preferred Print Location : Front	Max Print Size : 15 x 18 mm
Product Box Size : 16 X 20.5 X 3 cm	Packing Details : 48 x 35 x 39 cm; 40 pcs/carton; gw/nw: 13 kg/carton	



**LOTIK**

**GSGL 101** - Black

**Giftology** Lotik is a gift set consisting of coarse grained passport holder and leather wrapped ballpoint metal pen. Its modern material is such that on engraving, golden color comes up in black and black color come up in grey. Packed in an elegant gift box.

(Passport Holder) Print Technique : FO, ENG, EMB	Preferred Print Location : Front Bottom	Max Print Size : 80 x 120 mm
(Pen) Print Technique : UV, SC, ENG	Preferred Print Location : Barrel	Max Print Size : 35 x 7 mm
Product Box Size : 16.5 X 16.5 X 3 cm	Packing Details : 38 x 38 x 38 cm ; 40 pcs/carton; gw/nw: 11 kg/carton	

**READY STOCK**



**KRIMT**

**GSGL 105** - Black **GSGL 106** - Grey

**Giftology** Krimt is a gift set consisting of coarse grained passport holder and card holder. Its modern material is such that on engraving, golden color comes up in black and black color come up in grey. Packed in an elegant gift box.

(Passport Holder) Print Technique : FO, ENG, EMB	Preferred Print Location : Front Bottom	Max Print Size : 80 x 120 mm
(Card Holder) Print Technique : SC, ENG	Preferred Print Location : Front	Max Print Size : 80 x 30 mm
Product Box Size : 16 X 20.5 X 3 cm	Packing Details : 48 x 35 x 39 cm; 40 pcs/carton; gw/nw: 13 kg/carton	



READY STOCK



GSGL 492 - TACNA

Giftology Set of Notebook and Digital Luggage Scale

(Notebook) Print T : UV, SC	Print L : Front	Max Print Size : 120 x 190 mm
(Luggage Scale) Print T : UV, SC	Print L : Front	Max Print Size : 15 x 20 mm
(Box) Print T : UV, SC	Print L : Top of Box	Max Print Size : 180 x 220 mm
Product Box Size : 3.7 X 19.6 X 23.2 cm		



GSGL 495 - NAZCA

Giftology Set of Wallet and Metal Pen

(Box) Print T : UV, SC	Print L : Top of Box	Max Print Size : 130 x 200 mm
(Wallet) Print T : UV, SC	Print L : Front Bottom	Max Print Size : 85 x 60 mm
(Pen) Print T : UV, SC	Print L : Next to Clip	Max Print Size : 25 x 5 mm
Product Box Size : 3.4 X 15 X 21 cm		



GSGL 491 - CUSCO

Giftology Set of Wireless Charger and TSA Lock

(Box) Print T : UV, SC	Print L : Top of Box	Max Print Size : 80 x 160 mm
(Charger) Print T : UV, SC	Print L : Top of Charger	Max Print Size : 100 x 60 mm
(Lock) Print T : UV, SC	Print L : Front	Max Print Size : 7 x 10 mm
Product Box Size : 3.3 X 9.7 X 17.7 cm		



GSGL 496 - VIRU

Giftology Set of Powerbank, Keyring and Metal Pen

(Box) Print T : UV, SC	Print L : Top of Box	Max Print Size : 130 x 200 mm
(Powerbank) Print T : UV, SC	Print L : Cover	Max Print Size : 135 x 92 mm
(Pen) Print T : UV, SC	Print L : Next to Clip	Max Print Size : 25 x 5 mm
(Keychain) Print T : UV, SC	Print L : Front	Max Print Size : 30 x 6 mm
Product Box Size : 3.4 X 15 X 21 cm		





## PERSONALIZATION

Add a touch of distinction to your bag with TUMI's personalization services and products.

### MONOGRAMMING

Personalize your bag with TUMI's hand-stamped artisan craftsmanship monogramming, complimentary for travel and business products that feature an exterior leather monogram patch or TUMI luggage tags. A variety of styles and colors are available to suit any distinguished traveler. Have your design, logo or initials carefully debossed into the material to add a personal and permanent touch to your TUMI product. Hotstamp your monogram with a brilliant metallic gold or silver print that outshines any ink design for an eye-catching personalization.



This catalog includes highlights of TUMI's best-selling product offerings for men and women, the perfect selection of gifting options for any occasion.



LUXURY ACCESSORIES



READY STOCK



SBTM 733 - TUMI Alpha 3 Pocket Shoulder Bag  
Print Technique : ENG on Front Patch    Max Print Size : 35 x 15 mm  
Print Technique : SC on Front            Max Print Size : 120 x 70 mm  
Product Size: 24 x 20 cm



LUXURY ACCESSORIES



READY STOCK



**MBTM 731**

TUMI® Alpha Bravo Core Collection - Aviano Slim Brief

From the TUMI Alpha Bravo collection of modern, unstructured day and travel bags comes this commuter-ready brief crafted in an exceedingly durable Ballistic fabric. Slim and well organized, it offers dedicated laptop and iPad compartments, numerous interior and exterior pockets and a removable shoulder strap.

Print Technique : ENG on Front Patch

Max Print Size : 35 x 15 mm

Print Technique : SC on Front

Max Print Size : 60 x 160 mm

Product Size: 40 x 30 cm

MOLESKINE®

*Craftsmanship*







Genuine Leather



READY STOCK



LAMOL 103 - Black LAMOL 104 - Brown

**MOLESKINE** This classic yet contemporary horizontal wallet features an unexpected match of two different types of leather – one smooth to the touch and the other textured and tactile. With plenty of space for both cards, cash and keepsakes, the smart Classic Match Horizontal Wallet with coin pocket moves effortlessly with you from elegant to everyday. Any variations in the appearance of the leather between one wallet and the next make you as unique as the combination of items you store inside.

Print Technique : EMB, FO, ENG Preferred Print Location : Inside Max Print Size : 85 x40mm  
 Product size : 12 x 9.5x 1.5cm Packing Details : 26 x 18 x 16cm ; 8 pcs /carton ; gw/nw: 1.8 kg / carton



Genuine Leather



READY STOCK



LAMOL 105

**MOLESKINE** This classic yet contemporary black horizontal wallet features an unexpected match of two different types of leather – one smooth to the touch and the other textured and tactile. With plenty of space for both cards, cash and keepsakes, the smart Classic Match Horizontal Wallet moves effortlessly with you from elegant to everyday. Any variations in the appearance of the leather between one wallet and the next make yours as unique as the combination of items you store inside.

Print Technique : EMB, FO, ENG  
Product size : 12 x 9.5 x 1.5cm

Preferred Print Location : Inside Max Print Size : 85 x 40mm  
Packing Details : 26 x 18 x 16cm ; 8 pcs /carton ; gw/nw: 1.8 kg / carton



Genuine Leather



READY STOCK



CODRU

LAMOL 101

The Classic Leather Clip Wallet is made from smooth, premium leather. As well as holding up to 10 cards, tickets, receipts and loose notes, it also features a central hinged metal clip that elegantly holds a number of bank notes in place. Designed to celebrate the clean look, this supple wallet is an elegant travel companion, built to accompany you wherever you go.

Print Technique : EMB, FO, ENG  
Product size : 11 x 9 x 1.5cm

Preferred Print Location : Inside  
Packing Details : 25 x 15 x 14cm ; 8 pcs /carton ; gw/nw: 1.25 kg / carton

Max Print Size : 85 x40mm



Genuine Leather



READY STOCK



LAMOL 102

**MOLESKINE** The black Classic Match Slim fold Wallet is a slim and lightweight wallet that hides huge potential. Made from two types of premium leather – one smooth and the other textured – it has space for up to 15 cards as well as all the notes, tickets, receipts and keepsakes you want to keep safely stored as you move around the city. Any variations in the appearance of the leather between one wallet and the next make yours as unique as the combination of items you carry inside.

Print Technique : EMB, FO, ENG  
Product size : 9 x19 x 2cm

Preferred Print Location : Inside      Max Print Size : 40 x 60mm  
Packing Details : 24 x 19 x 23cm ; 8 pcs /carton ; gw/nw: 2.6 kg / carton



Genuine Leather



FEATURES:

- ▶ Metallic Moleskine logo on front
- ▶ Metallic zip puller with logo
- ▶ Zip-around entry
- ▶ Multiple compartments
- ▶ 1 inner coin pocket with zip
- ▶ 12 credit card slots

READY STOCK



LAMOL 106

**MOLESKINE** Carry your most precious essentials everywhere and anywhere in a tactile black leather wallet with a secure zip closure.

Print Technique : EMB, FO, ENG

Preferred Print Location : Inside

Max Print Size : 40 x 60mm

Product size : 19.3 x 10.7 x 1.8cm

Packing Details : 30 x 18 x 24cm ; 8 pcs /carton ; gw/nw: 3.7 kg / carton



GENUINE LEATHER



FEATURES :

- Genuine soft leather cardholder
- Contrast grey stitch
- With modern PIERRE CARDIN pen
- Pocket to keep currency
- LED lights to display available power



LAPC 761 - LOUVRE

( Card Holder) Print Technique : SC, EMB, ENG Preferred Print Location : Max Print Size : 20 x 30mm  
 ( Pen) Print Technique : UV, ENG Preferred Print Location : Max Print Size :  
 Product Size : 11.2 x 8 x 0.4cm Packing Details : 63 x 32.5 x 25cm ; 100 pcs /carton ; gw/nw: 9.8 kg / carton

READY STOCK



GENUINE LEATHER

FEATURES :

- Genuine soft leather cardholder
- Contrast grey stitch
- With modern PIERRE CARDIN pen
- Phone pocket on the back
- Pockets to keep cards
- PIERRE CARDIN branded plain papers included



LAPC 763 - TILAT

( Card Holder) Print Technique : SC, EMB, ENG Preferred Print Location : Front Max Print Size : 30 x 50mm  
 ( Pen) Print Technique : UV, ENG Preferred Print Location : Max Print Size :  
 Product Size : 18 x 10.7 x 1.6 cm Packing Details : 78x 24 x 27.5cm ; 50 pcs /carton ; gw/nw: 13.5 kg / carton



GENUINE LEATHER

FEATURES :

- Genuine soft leather cardholder
- Contrast grey stitch
- With modern PIERRE CARDIN pen
- Pockets to keep credit cards, sim cards
- PIERRE CARDIN branded plain papers included



LAPC 762 - MARAIS

( Card Holder) Print Technique : SC, EMB, ENG Preferred Print Location : Max Print Size : 20 x 30mm  
 ( Pen) Print Technique : UV, ENG Preferred Print Location : Max Print Size : Product Size : 14 x 9 x 1.6cm  
 Packing Details : 69 x 38 x 25cm ; 100 pcs /carton ; gw/nw: 17.5 kg / carton

For consumption in selected East & West African countries

## CROSS - The Iconic Brand

The iconic writing instruments brand established in the United States in 1846. Famed as the brand used by American Presidents, Cross Leather Accessories have been extremely successful and the award-winning leather accessories collection is currently being retailed in over 40 countries across the globe. Over a short span, the leather accessories under CROSS's banner has managed to gather a lot of fame with two consecutive wins in Germany this year at the Red Dot Design Awards and ILM Offenbach Awards. CROSS products form an excellent gifting option.

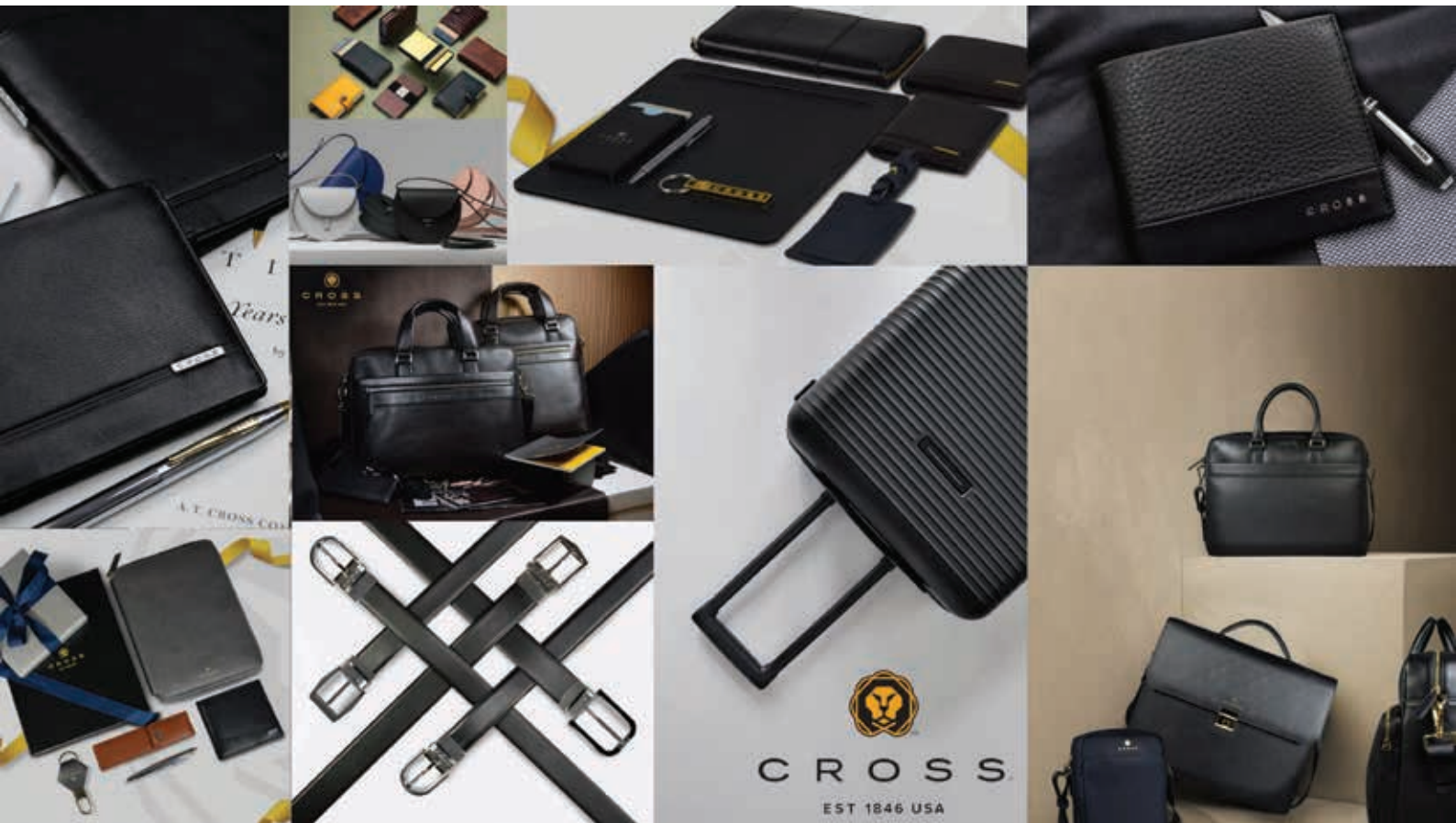



READY STOCK



**LACRS 885 - CHESTER**  
 Authentic Cross Branded wallet made with 100% Genuine Leather. Includes 4 Credit Card Slots, 2 Multi-purpose slip-in Pockets, 2 Currency Compartment and 1 Coin Pocket.  
 Print Technique : ENG, EMB Preferred Print Location : Inside Right Bottom  
 Max Print Size : 12 x 30 mm Product Size: 9 x 11 cm

**LACRS 886 - ELY**  
 Authentic Cross Branded wallet made with 100% Genuine Leather. Includes 8 Credit Card Pockets, 2 Currency Compartment and 2 Multi-Purpose Pockets.  
 Print Technique : ENG, EMB Preferred Print Location : Inside Right Bottom  
 Max Print Size : 25 x 50 mm Product Size: Product Size: 9 x 11 cm





- Holds Business Cards, ID Cards, Credit Cards
- Can hold folded currency notes
- Genuine Leather

- Genuine Leather
- Sleek & Elegant
- Holds Credit Cards

READY STOCK

**LACRS 890 - ALZEY**

Business and Credit Card Case Wallet

Print Technique : ENG, EMB  
Max Print Size : 30 x 30 mm

Preferred Print Location : Inside  
Product Size: 10.5 x 7.5 cm

**LACRS 891 - HOYA**

HOYA Credit Card Case Wallet

Print Technique : ENG, EMB  
Max Print Size : 30 x 20 mm

Preferred Print Location : Front  
Product Size: 9.6 x 8.2 cm



# CROSS GENUINE LEATHER PASSPORT HOLDER



READY STOCK



- Genuine Leather
- Holds Passport & Credit cards
- Pen slot discreetly holds pen
- Separate pocket can hold Boarding pass, Currency, Misc Documents
- An ideal travel companion from the renowned brand CROSS.

LACRS 892 - BARTH

International Passport Wallet  
Print Technique : ENG, EMB  
Product Size: 10 x 1 x 13.3 cm

Preferred Print Location : Inside

Max Print Size : 50 x 20 mm



- A5-most handy & appropriate size
- Hard Elegant gift box
- Credit card & Documents compartment
- Replacable Notebook
- Your prime meetings Accessory

READY STOCK



**Genuine Leather**

LACRS 889 - FURTH  
A5 Size Planner Cover  
Print Technique : ENG, EMB  
Product Size: 23.3 x 17.3 cm

Preferred Print Location : Inside

Max Print Size : 50 x 20 mm



98204-10 - LERICI  
*Tonino Lamborghini* Card holder in black full grain leather



98187-10 - MARINDI  
*Tonino Lamborghini* Cards + Key holder in black top quality leather

READY STOCK

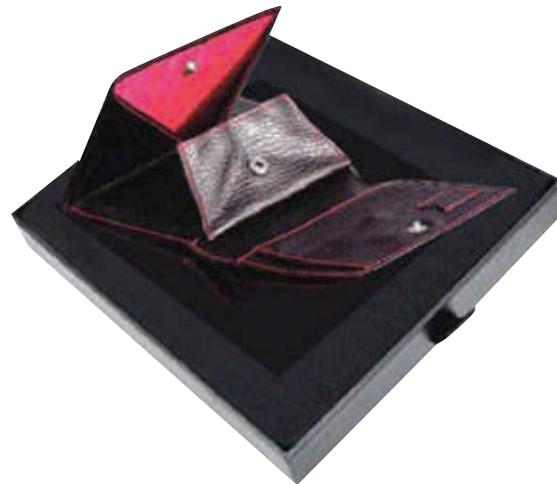

98201-10 - CECILIA  
*Tonino Lamborghini* Ladies wallet in black top quality Genuine Leather

# Genuine Leather Accessories from SANTHOME

Scan this QR code to learn  
more about the Anti-Microbial  
effectiveness and check  
certifications



Scan this QR code to see how  
Biomaster works on the surface  
of the product to effectively  
protect you 24/7





# SANTHOME

GENUINE LEATHER



**LASN 619 - POJ**  
SANTHOME Genuine Leather classic wallet with blue contrast stitching. The subtle and fine-detailing and the practical card- holder compartments underline the masculine and practical appeal of this wallet. Packed in a Santhome gift box.  
Print Technique : Eng, Emb, FO Preferred Print Location : Front Bottom Center  
Max Print Size : 65 x 40 mm Product Size: 12 x 9 x 1.5 cm  
Packing Details ( Without Box ) : 41 x 21 x 53 cms ; 150 pcs /carton ; gw/nw: 11.2 kg / carton

READY STOCK

# SANTHOME

GENUINE LEATHER



**LASN 659 - RANSOL**  
SANTHOME Tall, slim and highly elegant, Ransol is a leather coat wallet that is a perfect option to use with a suit. Tucked inside the breast pocket, it will not break the line of the suit while still carry 14 credit cards and keep all your banknotes crisp and neat in 3 slip-in pockets.  
Print Technique : FO, EMB, ENG Preferred Print Location : Front  
Max Print Size : 80 x 50 mm Product Size : 20 x 11 x 1 cm



# SANTHOME

MADE IN GERMANY



Brown



Black



**6301 - FLUGHAFEN**  
Print Technique : FO, ENG, EMB  
Preferred Print Location : Front Bottom Right  
Max Print Size : 95 x 205 mm

Genuine Leather.  
Article crafted & made in Germany.  
A Travel wallet - elegant & practical



# SANTHOME

MADE IN GERMANY



**6901 - MUNCHEN**  
Print Technique : ENG, FO, EMB  
Preferred Print Location : Front Bottom Center  
Max Print Size : 50 x 100 mm  
Product Size : 7.5 x 12 x 1.7 cm

Genuine Leather.  
Article crafted & made in Germany.  
A mobile phone holder designed to hold various currently used mobile phone instruments.

# Biomaster

## Antimicrobial protection

### How effective is Biomaster?

Very. Biomaster is proven to inhibit the growth of microbes by up to 99.99%.

### Is Biomaster safe?

Yes. It is based on silver ion technology, recognised for centuries with no harmful effects. Biomaster is used in medical, food and water applications.

### How long is Biomaster effective for?

Biomaster is tested to ISO standards and effective for the intended lifetime of the product it's added to. It is built-in and doesn't wear off or leach out.

### Does Biomaster affect a product in any way?

No. You can't see, smell or even taste Biomaster.

### Can a Biomaster-treated polymer be recycled?

Yes, it can be recycled effectively without any complications.

### Does Biomaster use nano-silver technology?

No. We don't use nano technology due to ongoing safety concerns.

### Why is Biomaster better than other silver based antimicrobial additives?

Biomaster pioneered the use of antimicrobial additives, and remains the recognised leader and most trusted supplier of antimicrobial technology for polymers, textiles, paper, paints and coatings.

Scan this QR code to see how Biomaster works on the surface of the product to effectively protect you 24/7



Scan this QR code to learn more about the Anti-Microbial effectiveness and check certifications



## HOW DOES BIOMASTER WORK?

**1** Biomaster binds to the cell wall disrupting growth



**2** The Biomaster ions interfere with enzyme production stopping the cell producing energy



**3** Biomaster interrupts the cell's DNA preventing replication

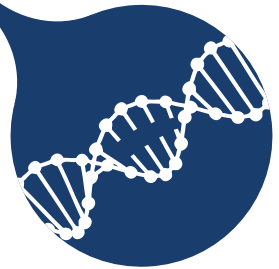

### How do I know if a product is Biomaster protected?

Unless it carries the Biomaster symbol, you don't. Ask before you buy it.

#### Products in this catalog with Added BIOMASTER TECHNOLOGY

1. @memorii Technology products with FSC certified Bamboo
2. Santhome Genuine Leather articles
3. Drinkware - Mugs



[www.biomasterprotected.com](http://www.biomasterprotected.com)

Biomaster is a registered trademark of Addmaster (UK) Ltd.

Use biocides safely. Always read the label and product information.



SANTHOME GENUINE LEATHER

SANTHOME GENUINE LEATHER

READY STOCK



LASN 658 BIO - TORREON

**SANTHOME PROTECT** Providing a safe and convenient way to carry all of your travel documents in one place, this wallet will organise even the most chaotic traveller. Ideal for storing passports, tickets and credit cards, 8 well-proportioned compartments offer quick and easy access to all your travel essentials for a smoother journey. This product contains Biomaster antimicrobial technology that provides protection against the growth of harmful micro-organisms for the lifetime of the product. A special tracker is built into the product to prove that the surface is treated with Biomaster. Packed in a Santhome gift box.

Print Technique : FO, EMB, ENG Preferred Print Location : Front  
Max Print Size : 80 x 50 mm Product Size : 20 x 11 x 1.5 cm

GSSN 186 BIO - TONALA

**SANTHOME PROTECT** Set includes Genuine Leather Travel Wallet and complimenting Metal Pen. Interior organization includes a passport holder, ID holder, three business or credit card pockets and boarding document holder. The travel wallet contains Biomaster antimicrobial technology that provides protection against the growth of harmful micro-organisms for the lifetime of the product. A special tracker is built into the product to prove that the surface is treated with Biomaster. Pen is also treated for antimicrobial effectiveness. Packed in a Gift Box.

(Wallet) Print Technique : FO, EMB, ENG Preferred Print Location : Front  
Max Print Size : 80 x 50 mm  
(Pen) Print Technique : UV, SC Preferred Print Location : Barrel  
Max Print Size : 6 x 40 mm



**Leather Article contains Biomaster antimicrobial technology that provides protection against the growth of harmful micro-organisms for the lifetime of the product. A special tracker is built into the product to prove that the surface is treated with Biomaster. Packed in Santhome gift box.**







### SANTHOME GENUINE LEATHER

- Genuine Leather Men's Wallet
- 13 Credit Card Pockets
- Elegant Contrast Stitching



**LASN 653 BIO - MORELIA**

**SANTHOME PROTECT** Genuine Leather Men's wallet with attractive contrast grey stitching. The inside of the wallet features 11 card slots, 1 big section for banknotes and 2 additional pockets for receipts and appointment cards.

Print Technique : EMB, FO, ENG Preferred Print Location : Bottom Center  
Max Print Size : 85 x 60mm Product Size : 10.5 x 14.5 x 2.5 cm

### SANTHOME GENUINE LEATHER



**LASN 655 BIO - CHALCO**

**SANTHOME PROTECT** Genuine Leather card case with attractive contrast grey stitching. Flip open to find the main section of card holder which can store up to 40 Business cards. An additional pocket on the other side to store credit card or ID card comes with a small window.

Print Technique : ENG, EMB, FO Preferred Print Location : Front Bottom  
Max Print Size : 50 x 70 mm Product Size : 10.5 x 7.8 x 1.5 cm

### SANTHOME GENUINE LEATHER



**LASN 666 BIO - TEPIC**

**SANTHOME PROTECT** Impressive genuine leather card holder with contrast grey stitching. It contains essential pockets to carry your cards & bank notes. Inside has 4 credit card / business card pockets and 1 currency compartment. There are 3 additional quick access card pockets in the back.

Print Technique : EMB, FO, ENG Pre. Print Location : Front  
Max Print Size : 55 x 70 mm Product Size : 10.5 x 7.5 x 1 cm

### SANTHOME GENUINE LEATHER



**LASN 667 BIO - BARI**

**SANTHOME** Genuine Leather Passport cover with contrast grey stitch and button closure. This passport holder has 8 credit card pockets, a currency compartment and space to hold 2 passports. Packed in Santhome gift box.

Print Technique : EMB, FO, ENG Pre. Print Location : Bottom Center  
Max Print Size : 85 x 50 mm Product Size : 15 x 11 x 1 cm



**READY STOCK**



**Above Leather Articles contain Biomaster antimicrobial technology that provides protection against the growth of harmful micro-organisms for the lifetime of the product. A special tracker is built into the product to prove that the surface is treated with Biomaster. Packed in Santhome gift box.**





# ANTI-MICROBIAL GENUINE LEATHER MEN'S WALLETS

## SANTHOME PROTECT

SANTHOME  
GENUINE LEATHER



**LASN 652 BIO - CANCUN**  
SANTHOME PROTECT Genuine Leather Men's wallet with contrast grey stitching. The inside of the wallet features 3 card slots, 2 section for banknotes and 1 coin pocket.

SANTHOME  
GENUINE LEATHER



**LASN 651 BIO - MERIDA**  
SANTHOME PROTECT Genuine Leather Men's wallet with contrast grey stitching. The inside of the wallet features 6 card slots, 2 section for banknotes and 2 additional pockets for receipts and appointment cards.

READY STOCK

SANTHOME  
GENUINE LEATHER



**LASN 656 BIO - TOLUCA**  
SANTHOME PROTECT Exclusive wallet with numerous compartments to keep everything you need together and organized. The wallet itself has a stylish and sophisticated look for any occasion. Consists of 2 bill compartment, 9 card slots along and compartment for coins.  
Print Technique : ENG, EMB, FO Preferred Print Location : Front  
Max Print Size : 85 X 60 mm Product Size : 9 X 11.5 X 1.5 cm



**Above Leather Articles contain Biomaster antimicrobial technology that provides protection against the growth of harmful micro-organisms for the lifetime of the product. A special tracker is built into the product to prove that the surface is treated with Biomaster. Packed in Santhome gift box.**





**SANTHOME**  
GENUINE LEATHER

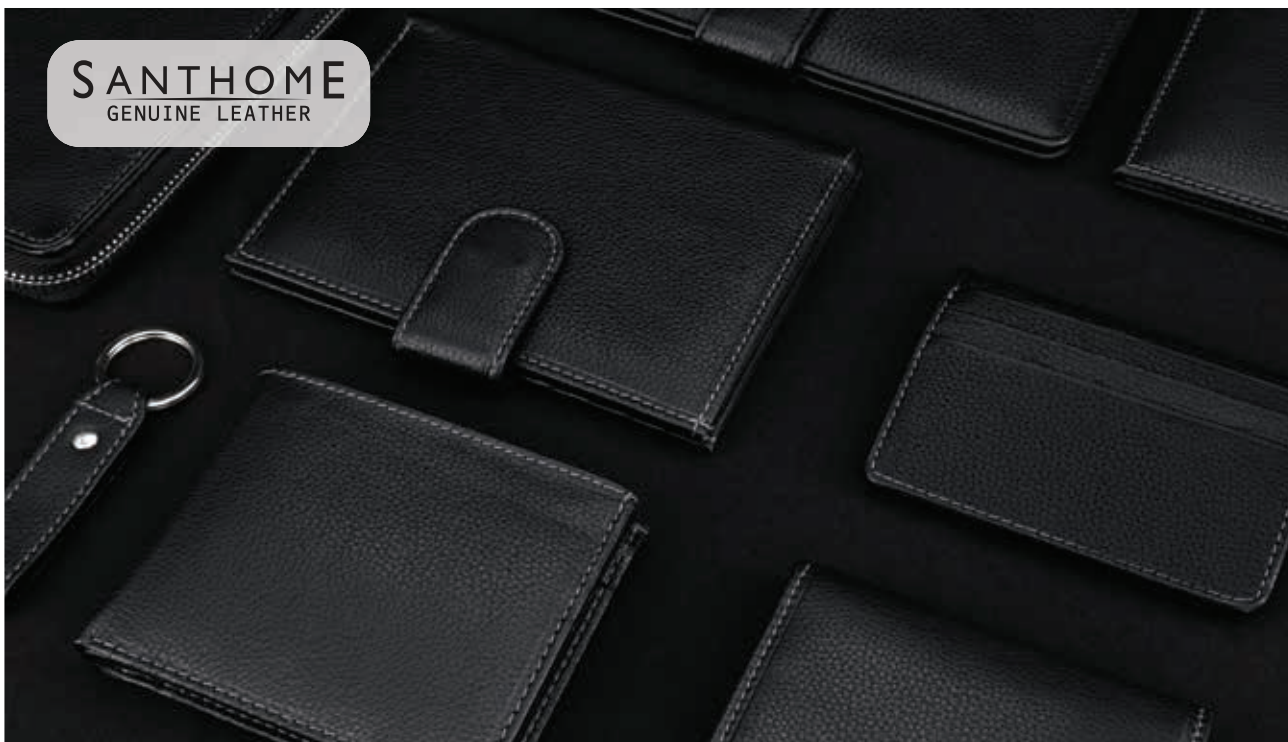

Leather Article contains Biomaster antimicrobial technology that provides protection against the growth of harmful micro-organisms for the lifetime of the product. A special tracker is built into the product to prove that the surface is treated with Biomaster. Packed in Santhome gift box.



**READY STOCK**



### GSSN 184 BIO - OLFUS

SANTHOME Olfus gift set consisting of a genuine leather passport holder and a matt finish metal pen. Packed in a gift box.

(Passport Holder) Print Technique : EMB, FO, ENG

Pre. Print Location : Bottom Center

Max Print Size : 85 x 50 mm

(Pen) Print Technique : UV, SC

Pre. Print Location : Barrel

Max Print Size : 7 x 70 mm

### GSSN 182 BIO - AKRANES

SANTHOME Akranes is a gift set consisting of genuine leather Passport holder, genuine leather Wallet and a metal pen. Packed in a nice gift box.

(Passport Holder) Print Technique : EMB, FO, ENG

Pre. Print Location : Bottom Center

Max Print Size : 85 x 50 mm

(Wallet) Print Technique : EMB, FO, ENG

Pre. Print Location : Bottom

Max Print Size : 85 x 60 mm

(Pen) Print Technique : UV, SC, ENG

Pre. Print Location : Barrel

Max Print Size : 7 x 70 mm



SANTHOME GENUINE LEATHER



GSSN 498 BIO - HAIGER

SANTHOME PROTECT Gift set consisting of wallet, cardholder both made from genuine grained leather, and metal pen. The Wallet and Cardholder contain Biomaster antimicrobial technology that provides protection against the growth of harmful micro-organisms for the lifetime of the product. A special tracker is built into the product to prove that the surface is treated with Biomaster. Pen is also treated for antimicrobial effectiveness. Packed in a Gift Box.

(Card Holder) Print Technique : EMB, FO, ENG Pre. Print Location : Front
Max Print Size : 55 x 70 mm
(Wallet) Print Technique : EMB, FO, ENG Pre. Print Location : Bottom
Max Print Size : 85 x 60 mm
(Pen) Print Technique : SC, UV, ENG Pre. Print Location : Barrel
Max Print Size : 7 x 70 mm

SANTHOME GENUINE LEATHER



GSSN 497 BIO - KLEVE

SANTHOME PROTECT Gift set consisting of wallet, cardholder both made from genuine grained leather, and metal pen. The Wallet and Cardholder contain Biomaster antimicrobial technology that provides protection against the growth of harmful micro-organisms for the lifetime of the product. A special tracker is built into the product to prove that the surface is treated with Biomaster. Pen is also treated for antimicrobial effectiveness. Packed in a Gift Box.

(Card Holder) Print Technique : EMB, FO, ENG Pre. Print Location : Front
Max Print Size : 55 x 70 mm
(Wallet) Print Technique : EMB, FO, ENG Pre. Print Location : Bottom
Max Print Size : 85 x 60 mm
(Pen) Print Technique : UV, SC Pre. Print Location : Barrel
Max Print Size : 7 x 70 mm

READY STOCK



Above Leather Articles contain Biomaster antimicrobial technology that provides protection against the growth of harmful micro-organisms for the lifetime of the product. A special tracker is built into the product to prove that the surface is treated with Biomaster. Packed in Santhome gift box.





LAGL014 - WELZOW

Giftology Basic genuine leather Passport cover packed in a gift box

Print Technique : FO, EMB, SC

Preferred Print Location : Front

Max Print Size : 70 X 80 mm

Product size : 14.5 X 10 cm

Packing Details : 53 X 52 X 28 cm ; 60 pcs /carton ; gw/nw: 15.5/14.5 kg / carton



READY STOCK

LAGL001 - JONAVA

Giftology Elegant multi pocket genuine leather cheque book holder with button closure. Consists of 5 credit card slots and an ID pocket. Carry all your important documents such as cheque book, cards and other travel document conveniently with this thoughtfully designed wallet.

Print Technique : FO, EMB, ENG, SC

Preferred Print Location : Front Bottom

Max Print Size : 70 X 80 mm

Product size : 21.5 X 11.7 X 1.3 cm

Packing Details : 69 X 47 X 27 cm ; 100 pcs /carton ; gw/nw: 18.7 kg / carton



LAGL008 - PALANGA

Giftology A useful Genuine Leather Card Holder with button closure for the modern man. Features 6 Credit Card Pockets, 2 Slip in Pockets and a Zipper Pocket to keep coins, keys etc. Also features an ID pocket on the outside for easy access. Packed in a gift box.

Print Technique : FO, EMB, ENG, SC

Preferred Print Location : Front Bottom

Max Print Size : 55 X 75 mm

Product size : 10 X 7.5 X 1.2 cm

Packing Details : 47 X 29 X 26 cm ; 100 pcs /carton ; gw/nw: 8.3kg / carton



**LAGL 011 - RHINOW**

(Wallet) Print Technique : FO, SC, EMB

(Card Holder) Print Technique : FO, SC, EMB

Product size : (Wallet) 11 X 9 cm (Card Holder) 9.5 X 7.5 cm

Preferred Print Location : Front Centre Bottom on Wallet

Preferred Print Location : Front of Cards holder

Packing Details : 74 X 51 X 31 cm ; 100 pcs /carton ; gw/nw: 19/18 kg / carton

Max Print Size : 60 X 60 mm

Max Print Size : 30 X 70 mm



**LAGL 013 - TRIPTIS**

Print Technique : FO, EMB, SC

Product size : 11 X 9 cm

Preferred Print Location : Front Bottom

Packing Details : 61 X 51 X 25 cm ; 60 pcs /carton ; gw/nw: 17/16 kg / carton

Max Print Size : 50 X 50 mm

READY STOCK



**LAGL 004 - LINKUVA**

Giftology Genuine Leather Men's Mini Over-flap bifold wallet with space to keep all your pocket essentials. Features 9 Credit Card Pockets, 1 ID Pocket, 2 Slip in Pockets and a large bill compartment. Also features an ID pocket on the outside for easy access. Packed in a gift box.

Print Technique : FO, EMB, ENG, SC

Product size : 7.9 X 11 X 2 cm

Preferred Print Location : Front Bottom

Packing Details : 56 X 30 X 29 cm ; 100 pcs /carton ; gw/nw: 11.1 kg / carton

Max Print Size : 50 X 75 mm



**LAGL 009 - VIEVIS**

Giftology Basic Genuine Leather Card holder with 6 credit card pockets and 2 slip in pockets. Packed in a gift box.

Print Technique : FO, EMB, ENG, SC

Product size : 11.5 X 7.5 X 1.2 cm

Preferred Print Location : Front Bottom

Packing Details : 47 X 29 X 26 cm ; 100 pcs /carton ; gw/nw: 7.9 kg / carton

Max Print Size : 55 X 80 mm





- > 3 Zipper pockets in the front
- > 1 Zipper pocket in the back of pouch
- > Cow milled Nappa Leather- elegant beige / camel natural color
- > Adjustable strap makes for convenient strap-on

- > Travel hands-free, safe & secure
- > Large size for securing family belongings
- > Packed in cotton drawstring pouch

Elegant Cotton Pouch

**LAGL 018 - GRANSEE**

(Waist Pouch) Print Technique : FO, EMB, SC  
 (Cotton Pouch) Print Technique : SC  
 Product size : 34 X 17 cm

Preferred Print Location : Front Max Print Size : 30 x50mm  
 Preferred Print Location : Front Max Print Size : 170 xmm  
 Packing Details : 51 X 51 X 30 cm ; 50 pcs /carton ; gw/nw: 12.7/11.5 kg / carton



Elegant Cotton Pouch



- > Toiletries Pouch / Wash bag for organizing your travel
- > Zipper Pockets in front, at the back & on top
- > Spacious interior

**LAGL 019 - GUBEN**

Giftology Each leather wash bag in an elegant natural cotton drawstring pouch.

(Toiletry Pouch) Print Technique : FO, EMB, SC  
 (Cotton Pouch) Print Technique : SC  
 Product size : 25 X 10 X 13 cm

Preferred Print Location : Front Max Print Size : 40 X 50 mm  
 Preferred Print Location : Front Max Print Size : 150 X 300 mm  
 Packing Details : 61 X 56 X 46 cm ; 24 pcs /carton ; gw/nw: 13/12 kg / carton

READY STOCK



**GSGL 493 - TUMBES**

Giftology Set of Genuine Leather Card Wallet, Flashlight Keyring and Metal Pen

(Wallet) Print Technique : FO, EMB, ENG, SC  
 (Flashlight Keyring) Print Technique : SC, ENG  
 (Metal Pen) Print Technique : UV, SC  
 Product Box Size : 3.4 X 15 X 21 cm

Preferred Print Location : Front Bottom  
 Preferred Print Location : Body of the Flashlight  
 Preferred Print Location : Next to Clip

Max Print Size : 85 X 60 mm  
 Max Print Size : 20 X 6 mm  
 Max Print Size : 25 X 5 mm



PRESENTING A WALLET

THAT PROTECTS AGAINST FRAUD IN THE NEW WI-FI ERA.

How the card holder protects?

The aluminium Cardprotector protects your most important plastic cards not only against bending and breaking, but also against malicious parties reading your RFID and NFC cards. RFID (Radio Frequency IDentification) cards contain a chip and an antenna for wireless communication. Examples of RFID cards include the Travel card, ID cards, the latest generation of credit cards and bank cards, as well as various access passes.

Using the Cardprotector

The Cardprotector can hold a maximum of 7 cards. If only embossed cards are used, the capacity is 5 cards. Position the cards you use the most at the back or front and they will slide out sufficiently to be used. Slide out the cards with ONE movement of the slider on the side. The radio signal, although still greatly reduced, will now be sufficient for contact over a short distance. This means that you can use your RFID-NFC cards easily and securely. After use, slide your cards back into the Cardholder by pressing down on them lightly.



Scan Below QR code to watch product video



- > Rfid Protection Wallet
- > Slide-Open Mechanism
- > Designed In Europe



READY STOCK

Genuine Italian Leather



Red



Packaging



White

ITALE

LASN 611 - Red LASN 614 - White

SANTHOME

Print Technique : SC, ENG, EMB Preferred Print Location : Front Top Max Print Size : 50 x 50 mm

Product Size : 7 x 10 x 2.5 cm Packing Details : 42.6 x 25.3 x 20.7 cm ; 50 pcs /carton ; gw/nw: 8.1 kg / carton

PU Leather



Pink



Packaging

VITL

LASN 603 - Pink

SANTHOME Cardholder cum Wallet with RFID protection . Designed in Europe.

Print Technique : SC, UV, ENG, EMB Preferred Print Location : Front Top Max Print Size : 50 x 50 mm

Product Size : 7 x 10 x 2.5 cm Packing Details : 42.6 x 25.3 x 20.7 cm ; 50 pcs /carton ; gw/nw: 8.5 kg / carton





Grey

- Anti-Theft
- Cut Proof
- Weight Balance



**Bobby Elle**  
Anti - Theft Backpack  
Bobby for Her !!



Light Blue



BOBBY ELLE

BGXD 613 - Grey    BGXD 616 - Light Blue

**XDDDESIGN** The Bobby Elle is not just a fashionable backpack, it also protects you from getting pickpocketed. With hidden zippers there is no way of getting into the backpack while carrying it. However strategically placed hidden pockets on the back of the backpack will give you as user easy access to smaller items when needed. The front of the backpack is protected with a PP board inside which will prevent thieves from cutting through the backpack and reflective strips on the front will ensure your night safety. This backpack will make sure your belongings will stay safe while keeping it fashionable. Registered design®

Print Technique : SC, HT

Preferred Print Location : Front

Max Print Size : 80 x 40 mm

Product Size : 30.5 x 23 x 11 cm

Packing Details : 36 x 57 x 58 cm ; 8 pcs /carton ; gw/nw: 10.01 kg / carton

READY STOCK



by *Conino Lamborghini*

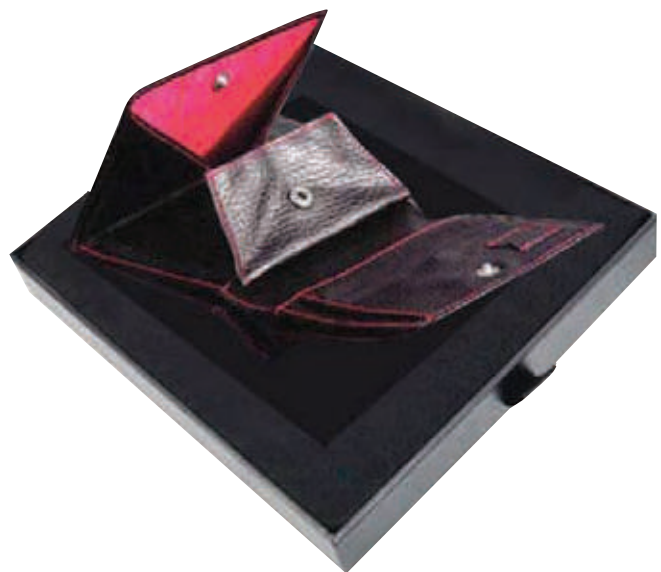

98201-10 - CECILIA

*Conino Lamborghini* Ladies wallet in black top quality genuine leather

READY STOCK

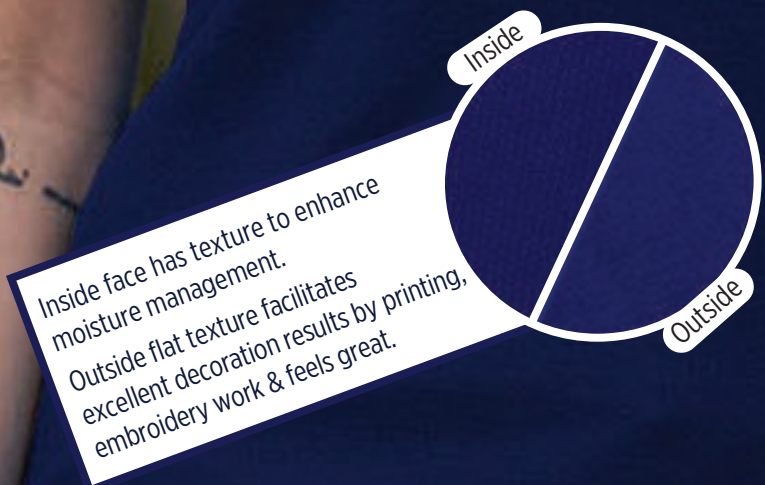



Colours in Ready Stock\*



Black



White



Navy Blue



Grey Melange

Item : WBDNC | Content : Dryncool fabric with UV protection  
Measurement : Gulf | Sizes Available : S, M, L, XL, XXL, 3XL

Dryncool is an advanced Moisture Management system (MMS) that helps keep the skin cooler & drier - more comfortable by transporting sweat to outer layer.

Executive wear.

Premium quality.

No-fuss performance.

Creaseless.

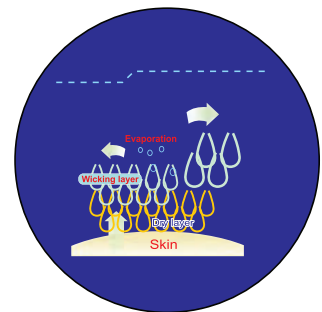

Dryncool Mechanism

READY STOCK

UV protection fabrics are rated between UPF 25-39. Ultraviolet protection factor (UPF) measures blockage of UV-A and UV-B rays. A UPF rating of 25-39 means that our fabric allows 1/25th to 1/39th (2.56- 4%) of UV radiation that falls on the surface of the fabric to pass through it. Thus, 96-97.4% of UV rays are not allowed to reach your skin thereby protecting the skin from sunburn and long term skin damage.



Tagless label

Print Technique :

- 1 Screen Printing
- 2 Heat Transfer
- 3 Embroidery

Preferred Print Location : Max Print Size:  
Left Chest Area / Sleeve 80 x 50 mm

Care Instructions:



Packing:

52.5x 32.5x 45 cms ; 50 pcs /carton ; gw/nw: 21.5kg / carton  
\* Packing details may have ± 10% variation based on size breakup



Side slits with bartack

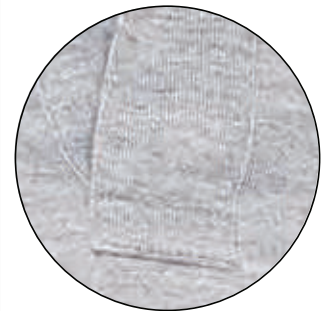

Double placket

\* Printing Limitations prevent exact fabric and color representation. The shades in the lots may differ due to lot-to-lot variations. The difference is no more than internationally accepted norms of the garments trade.



# LADIES GIFTS



by *Tonino Lamborghini*



**TROPEA-98181-19**

*Tonino Lamborghini* Watch with stainless steel case and strap, Mother of Pearl dial, Japan movement.

Packing Size : 11 x 13.5 x 6.5 cm

Packing Details : 47.8 x 40.8 x 50.8 cm

60 pcs /carton ; gw/nw: 16 kg / carton

READY STOCK

## Tacx

Made in THE NETHERLANDS

BIO BOTTLES MADE IN THE NETHERLANDS

**Tacx** bio-bottles is the water bottle for the Pro teams. This sturdy water bottle features a powerful design and a screw-on cap. A Tacx bio-bottle distinguishes itself thanks to a number of excellent functionalities and is easy to fill and clean.



**WB 003**  
Transparent /  
Purple Lid 750CC

**WB 003**  
Transparent /  
Pink Lid 750CC

- Bio Degradable
- 100% Recyclable
- Safe for Food Use
- Screw-On Cap With A Leak Proof Spout
- Secure Grip On Triangular Cap For Easy - Opening And Closing Of Bottle
- Certified Bio-Degradable Water Bottles.
- FDA Approved For Contact With Food.
- OSHA Approved As Non-Hazardous.
- Indefinite Shelf Life.



Print Technique : UV, SC

Preferred Print Location : Center

Max Print Size : (Flat) 33 x 100 mm, 230 x 100 mm ( Round )

Product Size : 7.5 x 25 X 7.5 cm

Packing Details : 39 x 39 x 52 cm ; 50 pcs /carton ; gw/nw: 5.5 kg / carton



**GSBG 915 - MANIKE**

**MANICURE SET & KEYCHAIN**

Gift set consisting of a manicure set and a keychain. Manicure set consists of Nail filer, Cuticle pusher, Nail clipper and toe nail Clipper. Packed in a nice gift box.

(Box) Print Technique : SC, UV Preferred Print Location : Front Plate

Max Print Size : 35 x 10 mm

(Manicure Set) Print Technique : SC, UV, ENG Preferred Print Location : Front

Max Print Size : 90 x 40 mm

(Keychain) Print Technique : SC, UV, ENG Preferred Print Location : Front

Max Print Size : 30 x 30 mm

Product Box Size : 14 x 16 x 3 cm

Packing Details : 34 X 29 X 38.5cm; 40 pcs/carton; gw/nw: 10.3 kg/carton



- Premium quality manicure / grooming instruments set
- Contains 7 gold-plated stainless steel instruments
- Made in Korea

**GSMS 9105 - CHELLES**

CHELLES Manicure Set is a world leading quality manicure / grooming set by THREE SEVEN with 7 gold plated instruments, including nail clipper, tweezer, diagonal clipper, beauty scissors, file, V-shaped push stick and ear pick. Made in Korea.

Print Technique : UV, SC Preferred Print Location : Front Max Print Size : 85 X 72 mm

Product Size : 10.2 x 7.7 x 1.7 cm

READY STOCK



- Premium quality manicure instruments set
- Contains 4 chrome-plated stainless steel instruments
- Made in Korea

**GSMS 9106 - GLINA**

GLINA Manicure Set is a world leading quality manicure / grooming set by THREE SEVEN with 4 chrome plated instruments, including nail clipper, tweezer, beauty scissors, file. Made in Korea.

Print Technique : UV, SC Preferred Print Location : Front Max Print Size : 110 X 54 mm

Product Size : 12 x 4.6 x 2.2 cm



# LADIES GIFTS



Bronze



Silver

A5



Gold

### SURAKARTA

NBMK 101 - Silver NBMK 102 - Gold NBMK 103 - Bronze

PU leather notepad in eye catching metallic colors. Available in golden, silver and bronze colors. With hard covers, elastic band and matching color fabric bookmark. Including 80 plain sheets in ivory color.

Print Technique : SC, UV, EMB

Preferred Print Location : Bottom Center

Max Print Size : 100 x 160 mm

Product Size : 14.7 x 21 x 1.5 cm

Packing Details : 37.5 X 23.5 X 37.5 cm ; 50pcs /carton ; gw/nw : 13.5 kg / carton



PP 271 - VITAN



VOGAR WIMP 210 - Pink



WIPP 755 - Pink



STMK 111 - KUPANG

READY STOCK



### EFNP 105 - Pink Notepad Pocket

Ecofriendly pocket notepad with 75 sheets of yellow sticky notes and neon strips in 5 exotic colours. Be organized!

Print Technique : SC, UV

Preferred Print Location : Front

Max Print Size : 50 x 75 mm

Product Size : 5.3 x 8 cm

VALUE



### ITMK 105 - UTENA

Practical and comfortable earphones with a bicolored design, 3.5mm jack connection and matching color cable. Presented in an case and with spare pads.

Print Technique : UV, SC

Preferred Print Location : Box

Max Print Size : 40 X 40 mm

Product Size : 7 X 7 X 2 cm

Packing Details : 32 X 43.5 X 46 cm ; 500 pcs / carton ; gw / nw : 15 kg / carton



**MOLESKINE**

CLASSIC NOTEBOOK FEATURES

Scan Below QR code to watch product video



- > Hard cover, rounded corners, elastic closure
- > Ribbon bookmark
- > Expandable inner pocket in cardboard and cloth
- > Front endpaper with 'in case of loss' notice
- > Ivory-coloured 70 g/m<sup>2</sup> acid-free paper
- > Elastic closure, ribbon bookmark, innerpocket
- > Fabric matches cover colour

Large ( 13 x 21 cm ) - Hard Cover - Ruled Notebooks



Red



Citron Yellow



Orchid Purple



White

OWMOL 305 - Red    OWMOL 307 - White    OWMOL 313 - Citron Yellow    OWMOL 314 - Orchid Purple

Packing Details : 47 x 33 x 24cm ; 48 pcs /carton ; gw/nw : 18 kg / carton

**XD COLLECTION**



Red

A5

- > A5 Hard Cover Notebook With Pen
- > 160 Pages Of 70g/m<sup>2</sup> Inside
- > Gift Box

GSXD 113 -

**XD COLLECTION** Ruled A5 hardcover standard notebook set including pen. 160 pages of 70g/m<sup>2</sup> inside. White coloured pages. Packed in Gift box.

(Notebook) Print Technique : UV, SC Preferred Print Location : Front  
 Max Print Size : 120 x 180 mm Preferred Print Location : Next to clip  
 (Pen) Print Technique : UV, SC Preferred Print Location : Next to clip  
 Max Print Size : 25 x 7 mm  
 Product Box Size : 22.5 x 17.2 x 2 cm  
 Packing Details : 38 x 25 x 36 cm ; 32pc /carton; gw/nw: 10.7kg / carton

**XD COLLECTION**



Red

A6

- > A6 Hard Cover Notebook With Stylus Pen
- > 144 Pages Of 70g/m<sup>2</sup> Inside
- > Gift Box

GSXD 124 - ALBURY

**XD COLLECTION** Ruled A6 hardcover classic notebook set including aluminium stylus pen. With elastic closure and bookmark ribbon. 144 pages of 70g/m<sup>2</sup> inside. Cream coloured pages. Packed in Gift box.

(Notebook) Print Technique : UV, SC Preferred Print Location : Front  
 Max Print Size : 110 x 60 mm Preferred Print Location : Next to clip  
 (Pen) Print Technique : UV, SC Preferred Print Location : Next to clip  
 Max Print Size : 25 x 7 mm Product Box Size : 15.7 x 12.2 x 2 cm  
 Packing Details : 46 x 19 x 30 cm ; 40pc /carton; gw/nw: 6.5 kg / carton

**Giftology**



Red

A5

- > PU Notebook Cover
- > 160 Ruled Pages, Rounded Corners
- > 1300 Meters Writing Length For Pen
- > Gift Box



Pink

LIBELLET

GSGL 203 - Red    GSGL 208 - Pink

**Giftology** Libellet is a notebook and pen set consisting of a hard cover PU notebook with a matching color pen with geometric design. The round cornered notebook consists of 160 ruled pages, 70 gsm with matching colored 3mm elastic closure, a bookmark and a pen loop. Packed in a gift box.

(Notebook) Print Technique : UV, SC, EMB Preferred Print Location : Front Max Print Size: 210 x 140 mm  
 (Pen) Print Technique : UV, SC Preferred Print Location : Clip Max Print Size: 8 x 37 mm Product Box Size : 22.5 x 19.5 x 2 cm  
 Packing Details : 30 x 25 x 40 cm ; 32 pcs /carton ; gw/nw: 12.50 kg / carton

READY STOCK



# ECO FRIENDLY DESKTOPS

# eco-neutral



KALMAR  
EFEN 210- Blue   EFEN 211- Green   EFEN 212- Red   EFEN 213- Pink   EFEN 214- Orange

**eco-neutral** Kalmar is a smart box that unfolds into a useful desk tool. Consists of a pen holder, 150 notepad pages, sticky notes in 5 different colors (25 sheets per color), a 2 year calendar and a secret box to keep those small things you want to hide from the world!

Print Technique : SC, UV   Preferred Print Location : Front   Max Print Size : 70 x 60 mm  
Product Size : 10.5 X 10.5 X 7 cm

READY STOCK



VERNON  
EFEN 201 - Blue   EFEN 202 - Eco Green   EFEN 205 - Pink

**eco-neutral** Vernon is a box that expands to be a useful workdesk tool. Comes with fun filled water marks, 6 pen holder slots, Memo pads 150 sheets of 70gsm, 30 paper clips and 2 year calendar.

Print Technique : UV, SC   Preferred Print Location : Side   Max Print Size : 110 x 110 mm  
Product Size : 11.5 X 11.5 X 11.5 cm   Packing Details : 48.5 X 36.5 X 46 cm; 48 pcs/carton; gw/nw: 16.5 kg/carton





Giftology



- > Convenient eco-friendly device holder
- > Smooth, lacquered bamboo finish



ITGL 1124 - SINTRA

Giftology Bamboo Mobile Holder

Print Technique : UV, SC, EN

Preferred Print Location : Top

Max Print Size : 48 x 40 mm

Product Size : 8 x 6 x 2 cm



Scan Below QR code to watch product video



eco-neutral

READY STOCK



EFEN 220 - Couvin

eco-neutral Cardboard cube with lid. Folds out to reveal small sticky notes in 5 different colours (25 sheets per color), included 30 paper clips, 4 pen holder slots, business card slots, a mobile stand and most importantly, a wireless charger. The Wireless charger has a 5W output. A perfect tech desk accessory for the modern desk!!

Print Technique : UV, SC

Preferred Print Location : Front Max Print Size : 90 x 90 mm 44 x 17mm

Product Size : 10.5 x 10 x 10.5 cm

Packing Details : 44.5 X 27 X 42.5 cm; 75 pcs/carton; gw/nw: 15 kg/carton

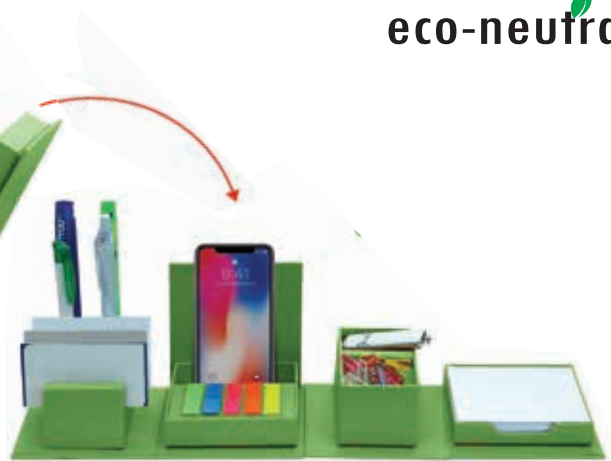

eco-neutral



EFEN 302 - CENON

eco-neutral Cenon is a box that expands to be a useful desk tool for your workdesk. Comes with 4 holes to keep pens, 2 pcs coasters, Memo pads 150 sheets of 70gsm, 30 paper clips and 25 sheets PET sticky notes.

Print Technique : UV, SC

Preferred Print Location : Side Max Print Size : 110 x 110 mm

Product Size : 11.5 X 11.5 X 11.5 cm

Packing Details : 48.5 x 36.5 x 46 cm; 48 pcs/carton; gw/nw: 17.5 kg/carton



# DESK WIRELESS CHARGING ACCESSORIES

eco-neutral



Phone, Watch, Earbuds charging simultaneously (shown above)

- Simultaneously charge 3 devices
- Fast charging 10W Wireless
- Sustainable Solid Bamboo material

ITWC 1101 - TRABEN

eco-neutral Traben is a 3-in-1 solid bamboo docking station with 10W wireless charging that can simultaneously charge 3 devices - mobile phone, wireless earbuds or AirPods and Apple or Android smartwatch - at once with a single Type-C connection.

(Bottom of Front) Print Technique : UV, SC, ENG

Preferred Print Location : Bottom of Front

Max Print Size : (Bottom of Front) 160 x 30 mm

(On support Backside) Print Technique : UV, SC, ENG

Preferred Print Location : On support Backside

Max Print Size : (On support Backside) 160 x 95 mm

Product Size : 21 X 18.2 X 13.2 cm

READY STOCK

@MEMORii



- Eco Friendly rPET Material
- 10 Watts Wireless Charger
- With Mouse pad, Desk Stand
- Elegant Fabric gives a Rich appearance
- Folds completely, hence a Travel-friendly accessory

ITWC 154 - VANI

@MEMORii Stay organized in your office or while traveling with our portable desk accessory, which can be packed flat. It can also unfold for use and maintain its position with a magnet. When in use, it can hold mobile phones, pens, serve as a mouse pad and a wireless charger - all in one. Great desk gift with an elegant linen finish and made sustainably with recycled rPET.

Print Technique : SC, UV, ENG

Preferred Print Location : Front & Back

Max Print Size : (Front) 70 x 30 mm (Back) 260 x 30 mm

Product Size : 22 X 28 cm Packing Details : 48.5 X 33 X 33 cm ; 30 pcs / carton ; gw / nw : 11/10 kgs/ carton



@MEMORii



- > Instant note taking on erasable LED writing pad
- > Mousepad with 10W wireless charging
- > Mobile stand and desk accessory gift



ITWC 1108 - SODEN

@MEMORii Desk accessory with in-built 3-in-1 mousepad, 10W wireless charging and a digital reusable writing pad that's great for taking instant erasable notes. Packed in a gift box

Print Technique : UV, SC, EMB  
Product Size : 30 x 21.5 x 1.3 cm

Preferred Print Location : On Mouse pad & On Stand

Max Print Size : (Mousepad) 260 X 150 mm (On Stand) 250 X 50 mm

READY STOCK



VALUE



- > 5 WATT Wireless Charger
- > Supports Latest Android And Ios Devices (Iphone 8 And Up)
- > Charge Your Phone Either In The Landscape (Horizontal) Position Or Portrait (Vertical) Position
- > Foldable Flat For Easy Carry

Scan Below QR code to watch product video



ITWC 151 - RABAT

Giftology Rabat is a 5 Watt Wireless Charger that is perfect for your desk. The integrated cable allows for the wireless charger to be used anywhere. You can place your phone either in the Landscape (Horizontal) Position or Portrait (Vertical) Position on this charger and within seconds the charging notification will appear. Compatible with all Qi enabled devices like Android latest generation, iPhone 8, 8S and X.

Print Technique : UV, EMB, SC  
Max Print Size: 20 x 50 mm  
Packing Details : 43 X 49.5 X 15 cm; 60 pcs/carton; gw/nw: 10.52 kg/carton

Preferred Print Location : Front  
Product Size : 32.5 x 9 x 0.7 cm

Giftology



- > 3-in-1 Mousepad, 15W Fast Wireless Charger & Mobile stand
- > Made with eco-friendly natural cork
- > Compact folding design - easy to carry
- > Non-slip base



ITWC 1119 - DEBNO

Giftology Natural Cork Mousepad with built in 15W fast wireless charger, non-slip base and integrated smartphone holder. Compatible with all wireless charging devices. With Type C cable included.

Print Technique : UV, SC  
Max Print Size : 80 X 200 mm

Preferred Print Location : Middle  
Product Size : 26.2 x 20 cm



# WIRELESS CHARGERS INCLUDING MULTI-FUNCTIONAL



Scan Below QR code to watch product video



- Powerful Sound Wireless Speaker with 10 hours playtime
- 5W Wireless Charger
- Digital Alarm Clock
- 4000 mAh Built-in powerbank

ITSP 204 - SOMOTO

Somoto is a multifunctional portable wireless charger with alarm clock, a powerful 5 W wireless speaker and a 4000 mAh built in powerbank. The speaker uses wireless BT 5.0 for smooth connection and has an operating distance up to 10 metres. With hands-free function and pick up. The 4.000 mAh battery allows you to play music for up to 10 hours or charge your mobile phone twice (depending on the size of your phone's battery) Input: 5V/2A. Output: 5V/1A. Wireless output: 5V/1A 5W.

Print Technique : SC, UV Preferred Print Location : Top Max Print Size : 30 x 50 mm  
Product Size : 10.6 x 8.5 x 8.7 cm Packing Details : 21.5 x 21.5 x 24 cm; 8 pcs/carton; gw/nw: 4.5/5.0kg/carton

READY STOCK



- 5 WATT Wireless Charger
- Including 100 cm Micro USB Cable
- Light-Up Logo When Engraved

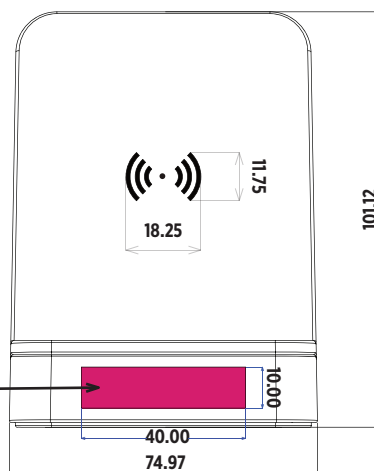

ITWC 203 - CORINTO

@MEMORii Charge your mobile devices without connecting a cable. Just place your mobile phone on the charger and wait for the charging notification to appear. The charging desk stand allows you to decorate your own logo on the pad; Once connected it will Light-Up for optimal exposure. Compatible with all Qi enabled devices like Android latest generation, iPhone 8, 8S and X. Input Type C: 5V/1A. Wireless Output: 5 Watt

Print Technique : UV, SC, ENG Preferred Print Location : Front Max Print Size : (LED Light-Up Logo) 40 x 10 mm  
Product Size : 8.5 X 7.5 x 10.1 cm Packing Details : 46.5 x 19.5 x 30.5 cm ; 30 pcs /carton ; gw/nw: 5 kg / carton



Detachable 10W Wireless Charging Pad



Joins left or right side using 2 way magnets

READY STOCK



Black

- > Detachable 10W wireless charger and mousepad joins by 2-sided magnets
- > Flexi-attach to left or right side, or use separately
- > With in-built ergonomic wrist rest & pen groove



Dark Grey



Navy Blue



Dark Green



DOBERAN

ITWC 1104 - Black ITWC 1105 - Dark Grey ITWC 1106 - Navy Blue ITWC 1107 - Dark Green

@MEMORii Doberan is a 2-in-1 mousepad with detachable and attachable 10W wireless charger pad. Using 2-sided magnets, the wireless charger pad can be detached and attached to the left or right side of the mousepad, providing a nice adaptability to left or right handed users. The mousepad has an in-built ergonomic wrist rest with cushioning. Packed in a gift box

Print Technique : UV, SC, EMB  
Product Size : 35 x 23 x 2.5 cm

Preferred Print Location : Next to Wrist Support

Max Print Size : 150 X 140 mm



- > Aluminum folding laptop stand
- > Portable folding - Easy to Carry
- > Adjustable Height and Laptop Angle for optimal neck and back comfort



READY STOCK

ITGL 1117 - SKARA

Giftology Skara is a high quality folding laptop stand made of durable aluminum and including extendable, height-adjustable legs with anti-slip rubber pads for a solid fit to the laptop computer and desk surface. Compact folding size which makes it ideal for carrying with you for travel. Presented in a gift box.

Print Technique : UV, SC, ENG Preferred Print Location : Front Max Print Size : (Both Arms) 75 X 20 mm  
Product Size : 25.6 x 4.4 x 1.6 cm



- > Hands-free laptop mount for your phone/tablet
- > Convenient use of dual screens for work or study
- > Contains powerful quality magnets and 3M sticker adhesives

ITGL 1118 - MALMO

Giftology MALMO consists of a metal phone or tablet mount for your laptop. Simply attach the Malmo mount on your laptop using the 3M stickers, and use the 2 additional metal rings on your devices of choice. You can then mount your devices next to your laptop screen using Malmo's powerful magnets, and benefit from hands-free phone/tablet accessibility and convenient use of dual screens. This device helps boost productivity while working, studying, or on the go.

Print Technique : UV, SC, ENG Preferred Print Location : Back Max Print Size : 65 X 23 mm or ø32 mm  
Product Size : 12.5 x 3.5 x 0.6 cm



- > Compatible with all wireless charging smartphones due to included magnetic ring
- > Made with powerful N52 magnets

- > Multi-tasking and productivity enhancements possible
- > 15W Fast Wireless Charging while phone is mounted

READY STOCK



**ITGS 1114 - RADLIN**

@MEMORI This 3-in-1 kit consists of a metal phone or tablet mount for your laptop, a matching 15W universal magnetic wireless charger that can charge any wireless compatible smartphone and a laptop stand. You can now benefit by raising your laptop for better back and neck posture, while enjoying hands-free phone/tablet accessibility, convenient use of dual screens and fast universal wireless charging - all at the same time. This kit will help boost your productivity while working, studying, or on the go.

(Laptop Stand) Print Technique : UV, SC, ENG Max Print Size: (Both Arms) 75 X 20 mm  
 Preferred Print Location : Front  
 (Wireless Charger) Print Technique : UV, SC, ENG Max Print Size : 65 X 23 mm or ø32 mm  
 Preferred Print Location : Back  
 (Mobile Holder) Print Technique : UV, SC, ENG Max Print Size : 50 X 20 mm  
 Preferred Print Location : Back

**ITGS 1115 - DABIE**

@MEMORI This 2-in-1 kit consisting of a metal phone or tablet mount for your laptop and a matching 15W universal magnetic wireless charger that can charge any wireless compatible smartphone, while it is mounted alongside your laptop. Both items are made from CNC polished aluminum with N52 magnets inside. The universal magnetic wireless charger comes with an extra magnetic ring that can be attached to any wireless charging smartphone, effectively converting them into a magnetic charging compatible device. You can now benefit from hands-free phone/tablet accessibility, convenient use of dual screens and fast universal wireless charging - all at the same time. This kit will help boost your productivity while working, studying, or on the go.

(Wireless Charger) Print Technique : UV, SC, ENG Max Print Size : 65 X 23 mm or ø32 mm  
 Preferred Print Location : Back  
 (Mobile Holder) Print Technique : UV, SC, ENG Max Print Size : 50 X 20 mm  
 Preferred Print Location : Back



# AN INTELLIGENT MUG WARMER & PHONE WIRELESS CHARGER use at home or in the office.



READY STOCK



Reinforced Porcelain



Smart Safety Feature - **Foreign Object Detection**  
Wireless charger and heating coil remain shut when a foreign object is detected

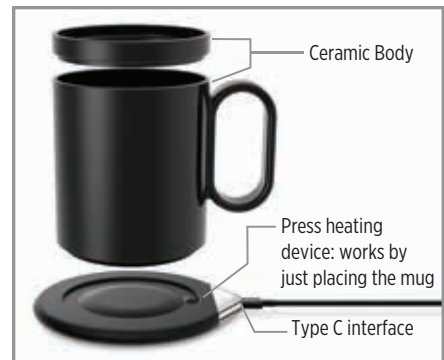

Ceramic Body

Press heating device: works by just placing the mug

Type C interface

- > Material is safe-to-touch even with ON
- > Continuous 8 hours working
- > Mug 350ml capacity
- > Constant temperature 55°C
- > Supports Qi standard wireless charging of phones incl. Apple & Android upto 10W.



CRIVITS  
ITHL 534 - WIRELESS CHARGER & CUP WARMER SET

Hans Larsen™ Works with compatible cup / mug only as effective contact points work in tandem with each other. This intelligent base recognises metal foreign objects placed accidentally, and stays shut. Panel is waterproof & safe to touch even when switched on. The radio bottom cooling sheet dissipates heat at high temperature & accumulates heat when temperature is low. Mode of heating - wireless induction. Wireless Coaster can be used as a normal Wireless Charger with mobile phones too!

Print Technique : SC, UV      Print Location : Plate & Front of Mug      Max Print Size : (Plate) 10 x 10 mm  
Product Size : ø8.5 x 10.5 cm      Packing Details : 59 X 41 X 35 cm; 24 pcs/carton; gw/nw: 19.5/18.5 kgs /carton



Intelligent Foreign object Recognition identifies metal items that are accidentally place in panel



Wireless / Heating Coaster is waterproof





CERTIFIED BY INTERTEK

- > 15W Wireless Charger (Fast Charging)
- > Made from Certified Recycled Plastic & FSC Bamboo
- > 3% of sales proceeds of each product committed to Water.org
- > Compatible with all wireless charging phones



RCS-certified Recycled 15w Wireless Charger  
ITWC 1113 - ELSTRA

@MEMORI Elstra is a CHANGE Collection Recycled (RCS-certified) 15W Wireless Charger with fast charging, made from certified recycled plastic and sustainable FSC-certified bamboo. The wireless charging is compatible with all wireless devices, Android latest generations and iPhone 8 and above. Packed in recycled kraft gift box. This wireless charger contributes 3% of sales to Water.org - a global NGO that provides millions with access to safe water and sanitation. By giving to Water.org, you are giving a GIFT THAT GIVES BACK.

Print Technique : SC, ENG Preferred Print Location : Front Top Max Print Size : 95 mm Product Size : ø10 x 0.7 cm

**SAY NO TO GREENWASHING**

*Tell the true story of sustainability with genuinely recycled ABS plastic*

**Certified by**



**GIFTS THAT GIVE BACK**

- 💧 785 million people - 1 in 9 - lack access to safe water. We are supporting Water.org to change this.
- 💧 For each CHANGE product sold, **3% of sales is donated** by the brand owners to Water.org to save lives with safe water and sanitation



**READY STOCK**



- > Made from Certified Recycled Plastic & FSC Bamboo
- > Recycled wireless speaker with BT5.1
- > 3% of sales proceeds of each product committed to Water.org
- > 6 hours playtime, and 10m wireless range



CERTIFIED BY INTERTEK



RCS-certified Recycled Bluetooth Speaker  
ITSP 1110 - ASPERG

@MEMORI Asperg is a CHANGE Collection Recycled (RCS-certified) Bluetooth 5W Wireless Speaker, made from certified recycled plastic and sustainable FSC-certified bamboo. The wireless speaker uses BT 5.1 for super smooth connection and long lasting play-time. The built-in 1,200 mAh lithium battery allows a play time up to 6 hours. Operating distance up to 10 metres. With mic and pick up function. Packed in recycled kraft gift box. This speaker contributes 3% of sales to Water.org - a global NGO that provides millions with access to safe water and sanitation. By giving to Water.org, you are giving a GIFT THAT GIVES BACK.

Print Technique : SC, UV Preferred Print Location : Front Max Print Size : 65 x 20 mm Product Size : 8.8 x ø7.5 cm



# DESK & TABLE ACCESSORIES



**DT 548 - BUTOF**  
 Budget Memo & Pen Holder  
 Print Technique : UV, SC, ENG Preferred Print Location : Front Plate  
 Max Print Size : 30 x 10 mm Product Size : 13 x 12.5 x 2 cm  
 Packing Details : 36 x 22 x 40 cm 50 pcs /carton ; gw/nw: 24.9 kg/carton



 **USB HUB + PHONE STAND**

**ITMK 122- BATAM**  
 Desk phone holder with USB hub and light up logo and phone stand.  
 Print Technique : ENG Preferred Print Location : Front  
 Max Print Size : 50 X 10 mm Product Size: 7.6 X 3.4 X 6 cm  
 Packing Details : 33.5 X 38 X 35 cm ; 200 pcs / carton ; gw / nw : 10 kg / carton

**READY STOCK**



**DT 636 - BITR**  
 Foldable, heavy brushed metal clock with separate panel for logo branding.  
 Packed in a white box.  
 Print Technique : SC, ENG, DM Preferred Print Location : Front  
 Max Print Size : ø35 mm Product Size : 5 x 5 x 1.5 cm  
 Packing Details : 35 x 22 x 15.7 cm ; 60 pcs/carton ; gw/nw: 6.8 kg/carton



**DT 641 - ETID**  
 Mobile Holder with Sticky note pad, USB HUB. Additional Sticky note pad refill is provided with the article.  
 Print Technique : UV, SC Preferred Print Location : Front  
 Max Print Size : 60 x 25 mm Product Size : 9.5 x 4.5 x 9.5 cm  
 Packing Details : 51 x 32 x 25 cm 50 pcs /carton ; gw/nw: 10 kg/carton



**DT 646 - LOMBL**  
 Desktop Clock with Maze Game  
 Print Technique : UV, SC Preferred Print Location : Bottom  
 Max Print Size : 60 x 15 mm  
 Product Size : 8 x 10 x 4.3 cm  
 Packing Details : 38 x 28 x 35.7 cm  
 60 pcs /carton ; gw/nw: 8 kg/carton

## XDDDESIGN®



Designed by:  
  
 Ryan McSorley  
 Ireland

**UI 1275 - OPTO**  
 XDDDESIGN® Opto will help you avoid those annoying moments where you have trouble reading the small letters in a restaurant, bank, hotel, or any other place. The timeless design makes reading with glasses trendy again. Registered design®  
 Print Technique : SC Preferred Print Location : Front  
 Max Print Size : 25 x 6 mm Product Size : 17 x ø3.8 cm  
 Packing Details : 57 x 27.5 x 41 cm ; 120 pcs /carton ; gw/nw: 16 kg / carton



STAITI-98193-19

**Tonino Lamborghini** Silver plated foldable clock in Lamborghini exquisite packaging

Print Technique : SC, ENG Preferred Print Location : Top Bottom  
 Max Print Size : 40 x 10 mm Packing Size : 14.5 x 3.5 x 10.5 cm  
 Packing Details : 34.5 x 31 x 21.5 cm ; 30 pcs /carton gw/nw: 11.9 kg / carton



FIUMARA-98195-19

**Tonino Lamborghini** Silver plated mouse pad in Lamborghini exquisite packaging.

Print Technique : SC, ENG, UV Preferred Print Location : Top  
 Max Print Size : 70 x 20 mm Packing Size : 29 x 3.5 x 23 cm  
 Packing Details : 31 x 25 x 37.5 cm ; 10 pcs /carton gw/nw: 6.4 kg / carton



L001

**Tonino Lamborghini** Silver plated CD rack in Lamborghini exquisite packaging

Print Technique : SC, ENG Preferred Print Location : Front  
 Max Print Size : 30 x 15 mm Packing Size : 19 x 8 x 3 cm Box Size : 33 x 18.5 x 8 cm  
 Packing Details : 40.5 x 35.5 x 44.5 cm ; 10 pcs /carton gw/nw: 11.1 kg / carton



**Pierre Cardin**  
**PARIS**

TCPC 770  
 TRIOMPE



- >> PIERRE CARDIN desk clock
- >> Silver plated parts
- >> Quartz mechanism

Print Technique : SC Preferred Print Location : On Box  
 Max Print Size : 20 x 30mm Product Size : 5 x 2.2 x 2.2cm  
 Packing Details : 57 X 36 X 36 cm ; 96 pcs / carton ; gw / nw : 13.5 kg / carton



TCPC 769  
 BELLENA

- >> PIERRE CARDIN desk clock
- >> Silver plated parts
- >> Quartz mechanism
- >> A connoisseur's collectable

Print Technique : SC Preferred Print Location : On Box  
 Max Print Size : 20 x 30mm Product Size : 7.2 x 5.5 x 0.5cm  
 Packing Details : 57 X 36 X 36 cm ; 200 pcs / carton ; gw / nw : 13.5kg / carton

**Pierre Cardin**  
**PARIS**

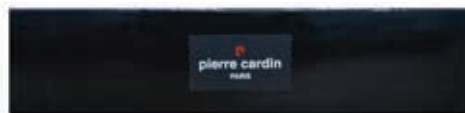

- >> PIERRE CARDIN letter opener
- >> Secured grip
- >> Silver PIERRE CARDIN logo

Print Technique : UV, ENG Preferred Print Location : Max Print Size : 5 x 15mm  
 Product Size : 19.5 x 1.2 x 0.5 cm Packing Details : 42X 31 X 29 cm ; 100 pcs / carton ; gw / nw : 12.4 kg / carton



STPC 783  
 TRAPANI

READY STOCK



# SILVER PLATED DESK ACCESSORIES

Pierre Cardin  
PARIS



### FEATURES :

- PIERRE CARDIN silver plated photo frame
- Silver PIERRE CARDIN logo
- Smooth premium metallic surface



DTPC 776 - EUSTACHE

Print Technique : UV, ENG Preferred Print Location : Front  
 Max Print Size : 7 x 20 mm Product Size : 8.5 x 9.5 x 2.5 cm  
 Packing Details : 42 X 31 X 29 cm ; 66 pcs / carton ; gw / nw : 20.5 kg / carton



### FEATURES :

- PIERRE CARDIN silver plated keyholder with photo frame
- strong magnets to secure the key
- PIERRE CARDIN silver logo



MCPC 786 - GIVERNY

Print Technique : UV, ENG Preferred Print Location : Top  
 Max Print Size : 8 x 30mm Product Size : 16.5 x 17.5 x 1.5 cm  
 Packing Details : 57X 36 X 36cm ; 60 pcs / carton ; gw / nw : 32.5 kg / carton

READY STOCK



Pierre Cardin  
PARIS

BITONO

DTPC 777 - Silver

\*Pierre Cardin Memo Pad \* Silver Pierre Cardin Logo  
 Print Technique : ENG Preferred Print Location : Top  
 Max Print Size : 10 X 30 mm Product Size : 9.5 X 11 X 3 cm  
 Packing Details : 42 X 23 X 32 cm ; 45 pcs / carton ; gw / nw : 18.65kg / carton



Pierre Cardin  
PARIS

SEINE

DTPC 778 - Black

\*Pierre Cardin Phone/Card Stand \* Leather Pad to keep accessories \*Silver Pierre Cardin Logo  
 Print Technique : ENG, EMB, FO Preferred Print Location : Top  
 Max Print Size : 12 X 60 mm Product Size : 16.5 X 12.6 X 2 cm  
 Packing Details : 42 X 23 X 32 cm ; 39 pcs / carton ; gw / nw : 7.80kg / carton



TCPC 764  
CHAUMONT

TCPC 763  
MONTENA

TCPC 768  
MONCEAU

TCPC 767  
VILLETTE

TCPC 762  
FANONA

TCPC 761  
TUILER

TCPC 766  
CLUNY

TCPC 765  
CASONA

**FEATURES :**

- > PIERRE CARDIN crystal clocks in 2 sizes
- > quartz movement
- > PIERRE CARDIN silver logo
- > perfect desk accessory!!

**READY STOCK**



CLPC 780  
VITERBO

CLPC 779  
SULPICE

**FEATURES :**

- > Handheld PIERRE CARDIN calculator
- > Slide open mechanism
- > Silver plated PIERRE CARDIN logo
- > Digital comfortable display



**FEATURES :**

- > Silver plated PIERRE CARDIN Logo
- > Electronic Footscale

STPC 784 - MOGADOR  
Product size : 31 x 4.2 x 1.3 cm  
Packing Details : 57 x 36 x 36cm; 200pc/carton; gw/nw: 20.7 kg /carton

Print Technique : SC Preferred Print Location : On Box  
Max Print Size: 40 x60 mm Product Size : 10.5 x 7 x 1 cm



# MOUSEPADS & COASTERS



ITLC 903



ITLC 903



ITLC 901 & 902



READY STOCK

**ITLC 901 - AARHUS**  
5mm Square shape  
sublimation mouse pad

**ITLC 902 - ODENSE**  
3mm Square shape  
sublimation mouse pad

**ITLC 903 - HORSSENS**  
Round sublimation  
mouse pad



**DTLC 801 - LUBLIN**  
Square Wooden Coaster



**DTLC 804 - PLOCK**  
Round Cork Coaster



**DTLC 803 - MALBORK**  
Round Wooden Coaster



**DTLC 802 - RADOM**  
Square Cork Coaster



High Quality

Regal Velvet Carry Pouch

### PMSN 9103 - SAJADA

The faithfuls concentrate on their prayer and spiritual connection. Sajada mat provides a comfortable experience to make it easier to focus. Folding into an elegant velvet pouch, the Sajada mat is made with natural rubber with soft suede finish and is purpose-built for all situations-use it at home, outside and during travel. Designed to help a seeker with their inward journey.

Print Technique : SC

Preferred Print Location : Front & Back of Pouch

Max Print Size : 220 x 160 mm

Product Size: 107 X 68 cm

READY STOCK



High Quality

Regal Velvet Carry Pouch

### PMSN 9104 - SAJADA

The faithfuls concentrate on their prayer and spiritual connection. Sajada mat provides a comfortable experience to make it easier to focus. Folding into an elegant velvet pouch, the Sajada mat is made with natural rubber with soft suede finish and is purpose-built for all situations-use it at home, outside and during travel. Designed to help a seeker with their inward journey.

Print Technique : SC

Preferred Print Location : Front & Back of Pouch

Max Print Size : 220 x 160 mm

Product Size: 107 X 68 cm

**Bukhoor is the Arabic name given to scented bricks or a blend of natural traditional ingredients, mainly wood chips (Oudh the Arabic name for Agarwood/Aloeswood) soaked in fragrant oils and mixed with other natural ingredients (resin, ambergris, musk, sandalwood , essential oils and others).**

**10 Fragrances**

- Blue Musk
- Bull gin black
- Cool Terrain
- Lavender
- Mukhallat
- Oudh
- Rose Lilly
- Vanilla Arch
- White Oudh
- Zoya



**READY STOCK**



10 Assorted Fragrances in One Gift Pack= 50Tablets



50 Tablets of Vanilla Arch Fragrance



50 Tablets of White Oudh Fragrance

- > Small Tablets for Frequent use
- > No Coal required for burning; ignites with lighter
- > Non-Toxic ingredients used- Certified by MSDS Reports

- > Try assorted 10 fragrances or just Vanilla or just Oudh
- > Each Gift Pack = 10 Containers = 10 X 5 = 50 Tablets; good for almost 2 months of daily one-time use

BUKHOOR GIFT PACK

GSBK 381 - Glinde - Bukhoor Gift Pack - Assorted Fragrances    GSBK 382 - Aurich - Bukhoor Gift Pack - Vanilla Arch Fragrance

GSBK 383 - Ebern - Bukhoor Gift Pack - White Oudh Fragrance





**STMK 139 - BATU**

Box of 4 wooden pencils with hexagonal body and in natural finish. Presented in natural cardboard box with window.

Print Technique : SC, UV Preferred Print Location : Front Cover  
Max Print Size : 40 x 20 mm Product Size : 3 x 9 x 0.8 cm  
Packing Details : 27 x 23.5 x 47.5 cm ; 1000pcs / carton ; gw / nw : 12kg / carton



**BATAK**

**STMK 101 -Blue STMK 142 - Green**

Set of 5 pieces presented in natural cardboard box. Includes push-up mechanism ball pen and blue ink in recycled cardboard, wooden cylindrical body pencil, pencil sharpener, rubber and 15 cm ruler.

Print Technique : UV, SC Preferred Print Location : Box  
Max Print Size : 100 X 30 mm Product Size : 4.5 X 17.7 X 1.5 cm  
Packing Details : 38 X 34 X 48 cm ; 400 pcs / carton ; gw / nw : 14 kg / carton



**STMK 103 - KAMENO**

Set of 5 pieces. Includes 2 black mine pencils with cylindrical body, eraser and pencil sharpener. Presented in a ruler box wit

Print Technique : UV, SC Preferred Print Location : Rectangular Part  
Max Print Size : 15 X 32 mm Product Size : 15.5 X 4 X 1.3 cm  
Packing Details : 53 X 24.5 X 35 cm ; 500 pcs / carton ; gw / nw : 15 kg / carton



**ARCATA**

**STMK 143 - Heart STMK 146- Wink**

Ball pen with fun emoji designs in eye-catching yellow color. With push-up mechanism, soft body in glossy finish and original circular clip. Blue ink.

Print Technique : SC Preferred Print Location :  
Max Print Size : SC, 50 x 5 mm Product Size : 14 x ø0.9 cm  
Packing Details : 35 x 51 x 51 cm ; 1000 / carton ; gw / nw : 12.5 kg / carton

READY STOCK

STAY HAPPY STAY HEALTHY !!



**DUBLIN**

**DWMK 105 - Sunglass**

370ml, ceramic mug with fun emoji designs in eye-catching yellow color. Presented in an individual box.

Print Technique : SC, UV Preferred Print Location : Front  
Max Print Size : 38 x 60 mm Product Size : 8.2 x 9.8 cm  
Packing Details : 33 x 27.5 x 48 cms ; 36 pcs / carton ; gw / nw : 13 kg / carton



**ARTESIA**

**BPMK 124 - Wink**

Folding bag with fun emoji designs in eye-catching yellow color. Made of soft 190T polyester, with matching color drawstring and adjustment accessory.

Print Technique : SC, HT Preferred Print Location : Front  
Max Print Size : 265 x 200 mm Product Size : 40 x 38 cm  
Packing Details : 20x 45 x55 cm ; 400 / carton ; gw / nw : 10 kg / carton



Blue



White



Red

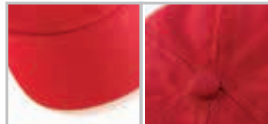

DELANO

SCMK 101- White SCMK 102- Red SCMK 103- Blue

5 panel kid cap in bright colors. In 100% cotton material, with embroidered ventilation holes and adjustable velcro closure.

Print Technique : SC,EMB Preferred Print Location : Front Max Print Size : 80 x 45 mm

Packing Details : 64 X 40 X 44 cm ; 15 kg Pcs: 300/ carton



GA 120 - GHISTU

Flaunt your love of golf with your own mini golf course. Get amateur putting practice in the office or play with children at home, while teaching them the basics of golf.

Print Technique : UV, SC, ENG Preferred Print Location : Side

Max Print Size : 340 x 20mm Product Size : 37.5 x 12 x 3.5cm

READY STOCK

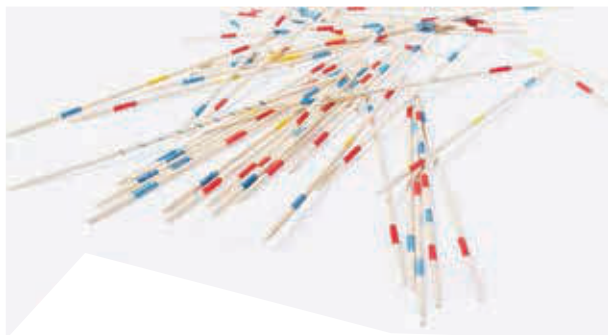

GMMK 103 - BYALA

Classic skill game mikado with 41 wooden sticks. Presented in wooden box with sliding cover.

Print Technique : ENG, SC

Preferred Print Location : On the side

Max Print Size: 100 X 20 mm

Product Size : 19.3 X 2.5 X 4.1 cm

Packing Details : 47 X 21 X 28 cm ; 100 pcs / carton ; gw / nw : 10 kg / carton

Navy Blue/Grey  
Medium



Navy Blue/Grey  
Kids



Grey/Black  
Kids



MARONI

HWSN 192 K - Grey/Black - Kids HWSN 193 K - Navy Blue/Grey - Kids

HWSN 193 - Navy Blue/Grey - Adults - Medium

SANTHOME PROTECT Reusable face mask with 6 layer triple filtration system. The comfortable design with adjustable nose clip, soft elastic ear loops and soft materials that prevent heat built-up ensures this mask can be used for a long time. Certified Bacterial Filtration Efficiency and Particulate Filtration efficiency of over 95% (>3 micron). Reusable upto 30 washes.

Print Technique : SC, HT Preferred Print Location : Side

Max Print Size : (Medium) 40 X 50 mm (Kids) Product Size : Medium 20 X 13 cm / Kids

Packing Details : 63.5 x 56 x 33 cm ; 500 pcs / carton ; gw / nw : 15.22 kg / carton



- > Useful Car Accessory
- > Car Phone Stand With Glass Breaker and Seat Belt Cutter
- > Excellent Branding Space



**MTGL 401 - BRNO**

Giftology Brno is a car phone holder with seat belt cutter and glass breaker. The excellent branding space on this product makes it an affordable and useful promotional product. Packed in a box.

Print Technique : UV, SC Preferred Print Location : Front  
Max Print Size : 25 x 15 mm Product Size : 9.7 x 5 x 2.8 cm  
Packing Details : 36.5 x 24.5 x 28.5 cm; 100pc/carton; gw/nw: 5.2 kg /carton



- > Torch
- > Booklight



**MTGL 811 - SUNDSVALL**

Giftology Sundsvall is a multifunctional torch with booklight to brighten up the darkest spaces. Packed in a gift box.

Print Technique : UV, SC Preferred Print Location : Booklight  
Max Print Size : 15 x 55 mm Product Size : 6.5 x 6.5 x 19.8 cm  
Packing Details : 68 x 35 x 43.5 cm; 100 pcs/carton; gw/nw: 14 kg/carton



**MTMK 107 - LONE**

Portable car mount for smartphones. With expandable grip that holds any smartphone with or without smartphone cover or case. Also has a 360° rotation head for flexible angle viewing.

Print Technique : DOM, UV Preferred Print Location : Front  
Max Print Size : 10 x 20 mm Product Size : 9.7 x 2.8 x 5 cm  
Packing Details : 50 X 31 X 38 cm ; 10 kg ; 300pcs / carton

- > Strong Magnet
- > Excellent Branding Space



**MTMK 106 - BEKASI**

Magnetic holder for smartphone with minimalist design and elegant black aluminum finish combined. With telescopic fixing system for car ventilation grill and adhesive accessory for smartphone. Presented in an attractive design box.

Print Technique : SC, ENG Preferred Print Location : Side & Front  
Max Print Size : 20 x 20 mm Product Size: Ø3.5 cm  
Packing Details : 36.5 X 36 X 46 cm ; 200pcs / carton ; gw / nw : 11 kg / carton



- > Car Emergency Multitool
- > Multi-functional Seat Belt Cutter & Glass Breaker



**MT 356 - THOR**

XDDESIGN Thor adds design to traditional Car Safety Hammer. It is the help you need during any car break down or even an accident. It combines safety hammer and seatbelt cutter in a robust body. Manual included. Registered design®

Print Technique : UV, SC Preferred Print Location : Front  
Max Print Size : 20 x 70 mm Product Size : 17.5 x 3 x 8.5 cm  
Packing Details : 0.06857 cbm ; 80 pcs /carton ; gw/nw: 19 kg / carton

READY STOCK



# AUTO TECH AUDIO FOR SMART PHONES



Small Headset



- > Safe Handsfree Experience
- > Bluetooth 4.0 For Smooth Connection
- > Charge And Call While Driving
- > Compatible With All Mobile Phones

ITCC 701 - FYCAR

@MEMORII Fycar is a unique design car charger with dual USB output and with integrated bluetooth headset that allows a safe hands-free experience whilst driving. The integrated earbud is charged when driving and is ultra-portable due to its small design (20 x 33 mm). The device uses the advanced bluetooth 4.0 connection which ensures a smooth connection and perfect sound quality. The magnetic top of the charger allows you to easily place the earbud back in the dock to charge it. The charger is suitable for all mobile phones. The earbud comes with additional ear tips in different sizes to fit all. Output 5V/1A ; 5V/2.1A

Print Technique : UV, SC, ENG Preferred Print Location : Front Max Print Size : 35 X 7 mm  
 Product Size : 8.6 x ø 2 cm Packing Details : 37.5 x 30.5 x 17 cm ; 40 pcs/carton ; gw/nw ; 4.75 kg/carton

READY STOCK



ITXD 740 - PENRITH

XD Car charger with Unique design & integrated wireless headset that allows a safe hands-free experience whilst driving. The integrated earbud is charged when driving and is ultra-portable due to its small design (20 x 33 mm). The magnetic top of the charger allows you to easily place the earbud back in the dock to charge it. The charger is suitable for all mobile phones. The earbud comes with additional ear tips in different sizes to get a good seal for all & can be used up to one hour on one single charge and can be fully re-charged in 1.5 hours. Output 5V/1A.

Print Technique : UV, SC, ENG Preferred Print Location : Front  
 Max Print Size : 35 x 7 mm Product Size : 8 x ø2 cm  
 Packing Details : 38.5 x 33.5 x 30 cm ; 80 pcs /carton ; gw/nw: 5.5 kg / carton



ITXD 741 - GRAFTON

XD Car charger with integrated wireless earbud using wireless BT 4.1 for perfect connection. The magnetic top of the charger allows you to easily place the earbud back in the dock to charge it. The charger is suitable for all mobile phones. The earbud comes with additional ear tips in different sizes to get a good seal. ABS material. Input 12-24V/output 2.1A. Registered design®

Print Technique : UV, SC, ENG Preferred Print Location : Front  
 Max Print Size : 7 x 20 mm Product Size : 8 x 3 cm  
 Packing Details : 55.0 x 35.0 x 21.0 cm ; 96 pcs /carton ; gw/nw: 8.6 kg / carton



**UI 1212 - TIPATO**

Silver / Black Polyester Sunshades

Print Technique : SC Preferred Print Location : Center Max Print Size: (Sunshade) ø500 mm (Pouch) ø130 mm  
 Product Size : 150 x 70 cm Packing Details : 57 x 70 x 14 cm; 100 pcs /carton; gw/nw: 14 kg/carton



**UI 1213 - SAIOTU**

DUPONT TYVEK SUNSHADES Stocks available in original Dupont Tyvek Sunshades (White) with a range of border colours to match logo & print matter

Print Technique : SC Preferred Print Location : Center  
 Max Print Size : (Sunshade) ø500 mm (Pouch) ø130 mm Product Size : 150 x 70 cm Packing Details : 55 x 71 x 11 cm; 100 pcs/carton; gw/nw: 15.7 kg/carton



**KT 011 - COUNTD**

Countdown Clock - Constant Reminder of Major Events

Print Technique : UV, SC Preferred Print Location : Top Max Print Size : 80 x 50 mm Product Size : 8.5 x 5.5 x 1 cm



CD case in soft PU. by *Tonino Lamborghini*



**CERASI - 98196-30**

Print Technique : SC Preferred Print Location : Front  
 Max Print Size: 100 x30 mm Product Size : 14.5 x 16.5 x 3 cm  
 Packing Details : 50.5 x 48.5 x 32.5 cm ; 60 pcs /carton ; gw/nw: 11 kg / carton



**VRANJE**

MSLC 886- Green MSLC 887- White MSLC 888 - Orange  
 MSLC 889 - Light Blue MSLC 890 - Royal Blue MSLC 891 - Black  
 MSLC 892 - Yellow  
 Silicone Wrist Band

READY STOCK



# MULTI UTILITY HIGH QUALITY TOOL SET

**XD**COLLECTION



Made from Beech Wood

- 01 Large nose pliers
- 02 Standard pliers
- 03 Wire cutter
- 04 Serrated blade
- 05 Knife
- 06 Phillips screwdriver
- 07 Bottle opener
- 08 Flat screwdriver
- 09 Small flat screwdriver
- 10 Can opener
- 11 Saw
- 12 File
- 13 Large screwdriver

**MTXD 101 - WOOD MULTITOO**

**XD**COLLECTION Strong and durable multitool with 13 functions. With beech wood case and high quality stainless steel tools. Tools include: Long nose plier, standard plier, wire cutters, serrated blade, bottle opener, large flat screwdriver, phillips screwdriver, knife, saw, small flat screwdriver, can opener, medium flat screwdriver, file. Packed in gift box.

Print Technique : SC,UV, ENG  
Product Size : 2.1 X 4.6 X 9.8 cm

Preferred Print Location : Front

Max Print Size : 40 x 10 mm

Packing Details : 40 X 19 x 29.50 cm ; 40 pcs /carton ; gw/nw : 11.5 kg / carton

READY STOCK

## Set of tools in a high class tin box

**1. 9 IN 1 Multi Purpose Tools With LED Light**

**2. 18 IN 1 Wallet Tool Set**

**Giftology**



- Needle pliers
- Regular pliers
- Wire cutters

Pocket Lightweight

Knife blade

Saw blade

Phillips screwdriver

Flat head screwdriver

Bottle opener

LED Torch

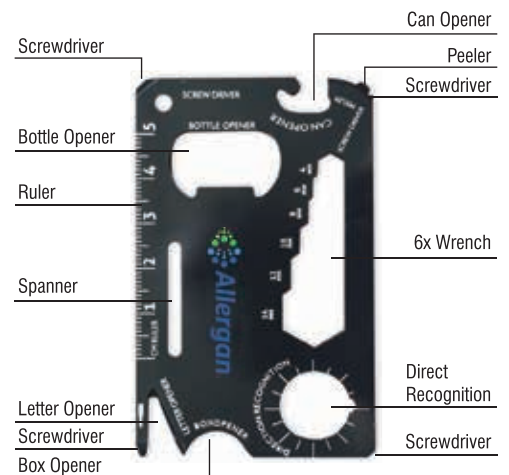

Screwdriver

Bottle Opener

Ruler

Spanner

Letter Opener

Screwdriver

Box Opener

Can Opener

Peeler

Screwdriver

6x Wrench

Direct Recognition

Screwdriver



**MTGS 210 - KRITAK**

**Giftology** Kritak is a tool set consisting of a 9 in 1 Multipurpose tool with LED light and a 18 in 1 wallet tool. These are packed together in an elegant tin box.

Print Technique : UV, SC,ENG

Preferred Print Location : Box Top

Max Print Size : 110 x 90 mm

Product Size : 12.8 x 10.3 x 2.7 cms

Packing Details : 29.1 X 24.1 X 37.4 cms ; 40 pcs / carton ; gw / nw : 11.8 kg / carton



- > Works with following bottles in this catalog
- Niesky - Page 164
- Sontra & Gera - Page 165
- Grodno - Page 166
- Geyer - Page 167
- Galati - Page 168

READY STOCK



**DWGL 3115 - SOMA**

SOMA is the perfect bottle holder for convenience when going outdoors. Slips in & out easily from the neck of bottle .

Print Technique : UV, ENG Preferred Print Location : Front & Back Max Print Size : 25 x 10mm



# Pierre Cardin PARIS



Playing Cards Set

- > PIERRE CARDIN playing cards set
- > Premium wooden box
- > Silver PIERRE CARDIN logo

PGPC 772 - TROCANO

Print Technique : SC, ENG Preferred Print Location : Top of Box  
Max Print Size: 20 x 30 mm Product Size : 11 x 15.8 x 3.2 cm  
Packing Details : 57 x 36 x 36 cm ; 68 pcs /carton ; gw/nw: 31.5 kg / carton

# Pierre Cardin PARIS



Wine Accessory

- > PIERRE CARDIN wine set
- > Premium wooden box
- > Silver PIERRE CARDIN logo

MCPC 771 - CONCONA

Print Technique : SC, ENG Preferred Print Location : Top of Box  
Max Print Size: 20 x 30 mm Product Size : 15.5 x 4.7 x 10.8 cm  
Packing Details : 57 x 36 x 36 cm ; 54 pcs /carton ; gw/nw: 23.3 kg / carton

READY STOCK



eco-neutral



HLEN 197 - HELLA

**eco-neutral** A compact and convenient alternative to single-use plastic cutlery. Make a natural choice with our Wheat Straw Cutlery Set consisting of a knife, spoon and fork packed in a convenient wheat straw box.

Print Technique : UV, SC Preferred Print Location : Case Max Print Size : 190 X 50 mm  
Product Size : 20.3 x 5.5 x 2.2 cm Packing Details : 32 X 24 X 49 cm ; 100pcs /carton ; gw/nw: 7.4 / 7.8 kg / carton

## CUTLERY SET







LY 884  
(Lanyard with detachable clip)



LY 885



LY 881



LY 886

## Lanyards



Round Badge Reels # 755



Drop Shape Badge Reels # 801

READY STOCK



Square Badge Reels # 756



Silver Chrome  
Badge Reels

# 802



# 803

## Badge Reels



# 754



# 752



# 751



# 753

Best quality lanyards are available with us in all standard colors and sizes (10 mm, 15mm & 20mm).

- ✔ Fabric - nylon polyester.
- ✔ Clips - alligator and swivel clips
- ✔ We can customize lanyards according to customer requirements.

## ID Card Holders



Keyfetch the only online lost property service to connect owners and finders directly and anonymously, at a click.



*Socially Responsible Gift*



## Tag Anything!

Keys, Cards, Bags, Phones, Laptops....



## BENEFITS

- Allows customers / employees to protect their valuables and allows you to advertise your brand at the same time
- Promote your brand by putting your logo on millions of your customers everyday belongings, visible 24/7, 365 days a year.
- Be part of solving a real life problem
- Nurture your socially responsible corporate image.
- Works globally

## FEATURES

- Directly and anonymously connects owners and finders of lost items
- 100% anonymous patented messaging system
- Private label offering designed to put your logo on millions of everyday items

READY STOCK

Keyfetch demonstration Video



Global Product Certification from Association of Chief of Police Officers (UK)

Keyfetch is the only service of its kind to have received an official accreditation from the UK Association of Chief Police Officers (ACPO) as part of the Secured by Design nationwide initiative.

[www.keyfetch.com](http://www.keyfetch.com)

## How It Works!



MSKF 101



MSKF 101- Keyfetch

KEYFETCH is a smart keychain that allows the owner of the keychain to find his/ her lost keychain by connecting the owner & the finder anonymously.

Print Technique: UV, SC, ENG

Preferred Print Location: (Box) Front

Max Print Size: ø 32 mm

Product Size: ø3.2 cm

Packing Details : 30 x 28 x 18 cm ; 1000 pcs /carton ; gw/nw: 8.3 kg / carton



ABS ( ANTI-MICROBIAL TREATED ) KEYRING

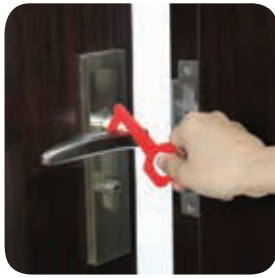

Red



Blue



Green



White



MASTY

MTGL 843 - White MTGL 844 - Blue MTGL 845-Red MTGL 846-Green

**Giftology** A robust hygiene tool that allows the user to open doors and push buttons without any direct contact. Manufactured from strengthened materials for extra durability. This product contains antimicrobial technology that provides protection against the growth of harmful micro-organisms for the lifetime of the product. Supplied as a keychain.

Print Technique : UV, SC

Preferred Print Location : Front

Max Print Size : 30 X 6 mm

Product Size : 8 X 3.5 X 0.4 cm

Packing Details : 39.5 x 21.5 x 39 cm ; 1000 pcs / carton ; gw / nw : 10.3 kg / carton



SBKC 1005 - FOOTE

Football stress reliever keyring for FOOTBALL lovers

Print Technique : SC

Preferred Print Location : Top

Max Print Size : 5 x 5mm

Packing Details : 37 x 33 x 29.5 cm

500 pcs /carton ; gw/nw: 5.5 kg/carton



KCMK 101 - DEVIN

Print Technique : ENG, SC

Preferred Print Location : Square Part

Max Print Size : 28 X 5 mm

Product Size : 1.7 X 6.7 X 0.3 cm

Packing Details : 34 X 29 X 49 cm

250 pcs / carton ;gw / nw : 10 kg / carton



KCMK 102 - MARFA

Smart nature line keychain. Obtained from cuts of beech wood, being all of them different and unique, each one with its own texture, thickness and color. With a wide printing area.

Print Technique : SC, ENG, UV

Preferred Print Location : Front/Back

Max Print Size : 40 x 24 mm Product Size: Variable

Packing Details : 40 x 36 x 40 cm; 800 pcs / carton;

gw / nw : 13 kg / carton

**Giftology**

ANTI-MICROBIAL TOUCHLESS KEYHOLDER

- > Over 62% Copper- naturally anti-bacterial
- > Press/Push using tip-contactless



MSKC 411 - SOROCA



KC 2023 A - FLAGUS

Print Technique : UV, SC, ENG

Preferred Print Location : Back

Max Print Size : 15 X 25 mm

Product Size : 3.5 X 8.3 X 0.5 cm

Packing Details: 39 x 24 x 28cm

200 pcs/carton; gw/nw: 6.3 kg/carton



2033 A - Leather Keyring

Print Technique :UV, SC, ENG, EMB

Preferred Print Location : Front

Max Print Size : 15 X 15 mm

Product Size : 7 X 2 X 0.7 cm



SIMEK

MSKC 505 - Black MSKC 506 - Silver

Print Technique : UV, SC, ENG

Preferred Print Location : Front

Max Print Size : 7 x 50 mm

Product Size : 8.8 x 1.6 x 10 cm

Packing Details : 34.5 x 25 x 37 cm;

270 pcs /carton; gw/nw: 10.5 kg/carton



KIMSE

MSKC 507 - Black MSKC 508 - Silver

Print Technique : UV, SC, ENG

Preferred Print Location : Front

Max Print Size : 8 x 30 mm

Product Size : 8.8 x 1.6 x 10 cm

Packing Details : 34.5 x 25 x 37 cm; 270 pcs

/carton; gw/nw: 10.5 kg/carton

READY STOCK

# BOXES



**PB 1050** - Wallet, Pen & Keyring Set  
Box Size : 4.1 X 16.7 X 19.4 cm



**WPK** - Wallet, Pen & Keyring Set  
Box Size : 3.4 X 15 X 21.4 cm



**PB 1052** - Box for Travel Wallet  
Box Size : 4.2 X 17 X 25.7 cm



**CHKC Box** - Card Holder & Key holder Set  
Box Size : 3 X 14.3 X 15.3 cm



**MWKC Box** - Men's Wallet & Key holder set  
Box Size : 3 X 14.3 X 15.3 cm



**WCC Box** - Box for Wallet & Card holder / Ladies wallet  
Box Size : 3.2 X 12.8 X 24.8 cm



**GSPB 184** - Wallet & Pen Set  
Box Size : 3.6 X 18 X 18 cm

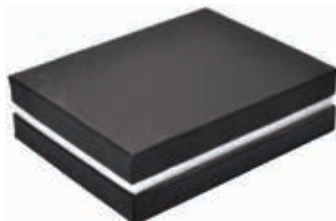

**MAPB 101** - Santhome Wallet box  
Box Size : 3.4 X 11.5 X 13 cm



**PB 1034** - Wallet, Card holder & Pen Set  
(Packaging for Biomaster products)  
Box Size : 4.4 X 19.3 X 25.3 cm

READY STOCK

# BOXES



**PB 1053** - Paper Pen Sleeve Packing  
Sleeve Size : 1.2 X 3 X 16.1 cm



Velvet Pen Sleeve  
**GPMK 102** - Black **GPMK 103** - Grey  
Sleeve Size : 2.5 X 15.5 cm



**PB 1045** - Metal Pen Box  
(Available 4 colors)  
Box Size: 1.8 X 3.9 X 17.8 cm



**PB 245** - Plastic Pen Box (Set)  
Box Size : 1.8 X 4 X 17 cm



**WIPB 110** - Paper Pen Box  
Box Size : 17.7 X 2 X 5.7 cm



**PB 762** - Pen Box (Paper)  
Box Size : 17 X 2 X 4 cm



**PB 1002** - Pen Box  
Box Size : 3.6 X 5 X 17 cm



**PB 1001** - Paper Pen Box  
Box Size : 2.5 X 7.5 X 17.5 cm

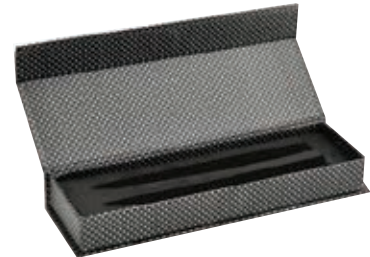

**PB 1055** - Hard board paper box  
for set of 2 pens  
Box Size : 17.5 X 3 X 7.5 cm



**MW Box** - Wallet Box  
Box Size : 3.2 X 12.5 X 15.8 cm



**PB 1041** - Hard box for Card holder  
Box Size : 2.1 X 7.1 X 11.3 cm



**WIPB 101** - (Box for Pens)  
Box Size : 17.4 X 2.7 X 6.6 cm

READY STOCK

# Sustainability and Transparency Organization and Certification



Textile Exchange is a global non-profit that works closely with members to drive industry transformation in preferred fibers, integrity and standards, and responsible supply networks.



The Global Recycled Standard (GRS) is an international, voluntary, full product standard that sets requirements for third-party certification of recycled content, chain of custody, social and environmental practices, and chemical restrictions.



The Recycled Claim Standard (RCS) is an international, voluntary standard that sets requirements for third party certification of recycled input and chain of custody. The goal of the RCS is to increase the use of recycled materials.

## THE IMPACT

### Recycling 1 Plastic Bottle\*

= CO2 reduction 25.2 g  
= fuel-savings 0.52 g  
= saving water 88.6 mL

### 1000 kgs Recycled PET

= 67,000 pcs bottles  
= CO2 reduction 4.2 tons  
= fuel-savings 36.4 kgs  
= saving water 6,200 L

\* Calculations based on 600 ml plastic bottle

## COMPLIANCE AND PRODUCT SAFETY

We ensure safe, long-lasting and aesthetic products from certified compliant supply chain.

## COPYRIGHT

Legal action will be taken against unauthorised infringements and / or reproduction of any content from this catalog without prior written permission.

## INTELLECTUAL PROPERTIES

All brand names and trademarks are properties of respective owners and used as examples only. Santhome, Hans Larsen, eco-neutral, @memorii, Giftology and dryncool are registered trademarks of Santhome Holdings Limited (BVI). Any infringement and duplication attempt will be dealt with legally.

## E&OE

Mistakes, color deviations, size variations, packaging discrepancy, etc.

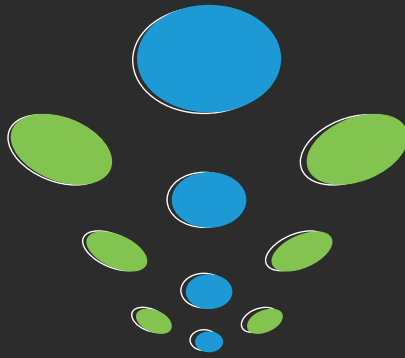

**AB**GROUP  
**BREEZ**



**WE ARE**

**Based in**

**KSA**

*Riyadh*

*Mecca*

*Jeddah*

*Dammam and Khobar*

*Abha*

*Hafar Al-Batin*

**UAE**

*Dubai*